



YASNAC PC NC Operating Manual

Version: Beta 1.0

SAFETY INFORMATION

PRECAUTIONS

1. Read this instruction manual in its entirety before using the operating functions available in the YASNAC PCNC.
2. The following warning symbols are used to indicate precautions that the user must be aware of to safely use this equipment. Failure to follow these precautions can result in serious or possibly even fatal injury and damage to products or related equipment or systems.



This symbol indicates the presence of a potentially *hazardous condition* which, if not avoided, could result in serious personal injury or death.



This precautionary symbol appears in labels attached to YASNAC products to alert the user to conditions requiring concern for safety.

SPECIAL SAFETY NOTE: This symbol indicates that **ELECTRICAL SHOCK HAZARD** condition exists. **DO NOT TOUCH** any electrical connection terminals when the power is on, and for at least 5 minutes **after** switching off the power supply. Warning label is located on the PCNC

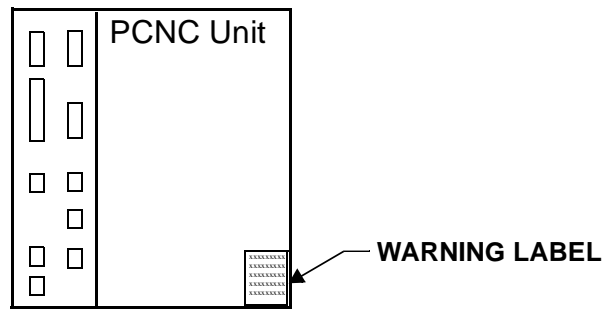

NOTICE

Printed _____. 1999. The information contained within this document is the proprietary property of Yaskawa Electric America, Inc., and may not be copied, reproduced or transmitted to other parties without the expressed written authorization of Yaskawa Electric America, Inc.

No patent liability is assumed with respect to the uses of the information contained herein. Moreover, because Yaskawa is constantly improving its high quality product, the information contained in this manual is subject to change without notice. Every precaution has been taken in the preparation of this document.

INFORMATION INDICATORS

The following symbols are used in this operating manual to emphasize particular information to the user:

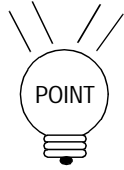

Indicates important information to be remembered, i.e., precautionary alarm displays to prevent damaging devices.

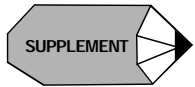

Indicates supplementary material.

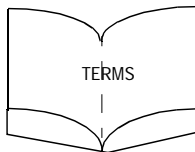

Indicates definitions of terminology that has not been explained before.

NOTES REGARDING SAFE OPERATION

It is important that the user should read this manual before installing, operating, performing any maintenance or inspecting the *YASNAC PC NC*. Also, the functions and performance of a NC machine tool are not determined by the CNC unit itself, therefore thoroughly read and familiarize yourself with the machine builder's documentation concerning the safe and most efficient ways to use the machine tool. Nevertheless, Yasakawa assumes no responsibility for damages resulting from the use of the information contained within this publication.

TABLE OF CONTENTS

1. OUTLINE OF THE PRODUCT

1.1	OUTLINE of the YASNAC SYSTEM	1-2
1.1.1	System Configuration	1-2
1.1.2	Environmental Requirements	1-3
1.1.3	Machine Operation Panel	1-4
1.1.4	General Specifications	1-5
1.2	PROTECTIVE FUNCTIONS.....	1-9
1.2.1	Emergency Stop	1-9
1.2.2	Overtravel	1-9
1.2.3	Stored Stroke Limit.....	1-10
1.2.4	Interlock Inputs.....	1-12

2. BASIC OPERATION OF YASNAC PCNC

2.1	GENERAL OPERATION FLOW	2-4
2.2	INSECTION BEFORE TURNING THE POWER ON	2-4
2.2.1	Inspection of the PCNC unit.....	2-6
2.2.2	Prepartion before Turning the Power ON.....	2-7
2.3	TURNING THE POWER ON/OFF	2-4
	AND INSPECTION AFTER POWER ON/OFF	2-8
2.3.1	Procedure for Turning the Power ON.....	2-8
2.3.2	Checking the Motors for Abnormalities.....	2-9
2.3.3	Procedure for Turning the Power OFF.....	2-9
2.3.4	Inspection of the Battery.....	2-10

2.4	MANUAL OPERATION (1)	2-11
2.4.1	Manual Rapid Traverse (RAPID).....	2-12
2.4.2	Jog Feed (JOG).....	2-13
2.4.3	Step Feed (STEP)	2-13
2.4.4	Handle Feed (HANDLE)*	2-13
2.5	MANUAL OPERATION(2)	2-15
2.5.1	Simultaneous 2- or 3-axis Handle Feed*	2-15
2.5.2	Manual Reference Point Return	2-16
2.5.3	Manual Reference Point Return to the Second Reference Point 1	2-18
2.5.4	1-line MDI	2-19
2.6	AUTOMATIC OPERATION (1)	2-20
2.6.1	Preparation of Automatic Operation.....	2-20
2.6.2	Memory Operation	2-22
2.6.3	MDI Operation	2-23
2.6.4	Feed Hold	2-23
2.6.5	Override	2-24
2.7	AUTOMATIC OPERATION (2)	2-25
2.7.1	Optional Stop	2-25
2.7.2	Optional Block Skip	2-25
2.7.3	Dry Run.....	2-26
2.7.4	Display Lock and Machine Lock	2-26
2.7.5	Auxiliary Function Lock.....	2-26
2.7.6	Z-axis Command Neglect	2-27
2.7.7	4th-axis Command Neglect	2-27
2.7.8	5th-axis Command Neglect	2-28

2.8	OPERATION INTERVENTION (during automatic operation)	2-29
2.8.1	Manual Operation Intervention (during automatic operation)	2-30
2.8.2	MDI Operation Intervention (during automatic operation)	2-30
2.8.3	Automatic Handle Mode Offset	2-30
2.8.4	Manual Absolute.	2-32

3. BASICS OF DISPLAY AND WRITING OPERATION

3.1	USER INTERFACE OVERVIEW	3-6
3.1.0	User InterfaceOverview	3-6
3.1.1	Status Bar	3-6
3.1.2	Battery Indicator	3-6
3.1.3	NC Execution Status	3-6
3.1.4	Motion Status	3-7
3.1.5	Alarm Message	3-7
3.1.6	Warning Message	3-7
3.1.7	Time/Date	3-7
3.1.8	Mode / MDI / Tool Bar	3-8
3.1.9	Mode Indicator	3-18
3.1.10	Menu Bar	3-14
3.2	RECURRING COMPONENTS	3-14
3.2.1	Positioning the Cursor	3-16
3.2.2	Nest Level Display	3-17
3.2.3	Shortcuts	3-17
3.2.4	Number Field	3-18
3.2.5	File Browser	3-19

3.3	RUN MENU	3-21
3.3.1	Production Screen	3-22
3.3.2	Proveout Screen	3-23
3.3.3	NC Switch Screen	3-29
3.3.4	Timers Screen	3-30
3.4	PROGRAM MENU	3-32
3.4.1	File Screen	3-32
3.4.2	Editor Screen	3-38
3.4.3	List Screen	3-45
3.4.4	Macro Variables	3-47
3.5	TOOL MENU	3-49
3.5.1	Offset Screen	3-49
3.5.2	Magazine Screen	3-52
3.6	SETUP MENU	3-53
3.6.1	Workshift Screen	3-53
3.6.2	Four (4) Position Screen	3-55
3.6.3	One (1) Position Screen	3-56
3.7	UTILITIES MENU	3-57
3.7.1	Log in Screen	3-57
3.7.2	System Screen	3-59
3.7.3	Maintenance Screen	3-60
3.7.4	Configuration Screen	3-61
3.7.5	Backup and Restore Screen	3-63
3.7.6	CPU Monitor Screen	3-65
3.7.7	Setting Parameters Screen	3-67

3.7.8	NC Parameters Screen	3-70
3.7.9	Machine Setup Screen	3-71
3.7.10	Pitch Error Screen	3-72
3.7.11	Torque Ripple Screen	3-74
3.7.12	Parameter Search Screen	3-75
3.7.13	High Speed Cutting Screen	3-77
3.7.14	User Install Screen	3-78
3.7.15	MTB Install Screen	3-81
3.7.16	PLC Parameters Screen	3-82
3.7.17	PLC Diagnosis Screen	3-83
3.7.18	Ladder Monitor Screen	3-88
3.7.19	Switch Label Screen	3-88
3.8	ALARM MENU	3-91
3.8.1	NC Alarm Screen	3-91
3.8.2	PLC Alarm Screen	3-93
3.8.3	Alarm History Screen	3-95
3.9	Help Menu	3-96
3.10	MMI Map Screen	3-96
3.11	Manual Screen	3-97
3.12	Offline Mode	3-98
3.13	Offline Mode Interface	3-98

4. MAINTENANCE

4.1	MAINTENANCE DATA	4-2
4.1.1	Checking the Status of Problems	4-2
4.1.2	Checking the NC Information	4-3
4.1.3	Display of Alarm Information	4-3
4.1.4	Cause of Alarm and Corrective Action	4-4

4.1.5	Troubleshooting (1)	4-5
4.1.6	Troubleshooting (2)	4-12
4.1.7	Alarms Not Indicated by Alarm Numbers	4-16
4.1.8	PCNC Alarms Not Indicated by Alarm Numbers	4-28
4.1.9	Touch Screen Maintenance	4-28
4.1.10	Mode of PCNC Operation	4-29
4.1.11	Self-Diagnosis Function	4-30
4.1.12	Hard Drive Mounting Replacement	4-32

APPENDIX 1. LIST OF PCNC INPUT/OUTPUT SIGNALS

1.1	INPUT SIGNALS (PLC > NC)	A1-2
1.2	OUTPUT SIGNALS (NC > PLC)	A1-9

APPENDIX 2. ALARM TABLE

2.1	CLASSIFICATION OF ALARMS	A2-2
2.2	ALARM TABLE (PCNC)	A2-3
2.3	TROUBLESHOOTING	A2-21

APPENDIX 3. PARAMETER TABLE

A3-1

USING THIS MANUAL

This manual describes the procedures for operating the *YASNAC PC NC*.

RELATED INFORMATION SOURCES

For additional information, refer to the following manuals:

TITLE OF DOCUMENT	CONTENTS
YASNAC PCNC Programming Manual (YEA-SIE-C844-2.2)	PCNC Program creation instructions
YASNAC PCNC/PLC Programming Manual (YEA-SIE-C844-0.1)	PLC Program creation instructions
YASNAC PCNC I/O Signal Manual (YEA-SIE-C844-2.3)	Describes functions between PCNC and PLC
YASNAC PCNC Connection Manual (YEA-SIE-C844-0.2)	Instructions for connecting PCNC with machines, machine interface and peripheral equipment
YASNAC PCNC Maintenance Manual (YEA-SIE-C844-2.9)	Describes service and maintenance procedures.

CAUTIONS

This manual describes all the option functions (identified by the “*” symbol) but some of these may not be available with your YASNAC PCNC. To determine the option functions installed in your PCNC, refer to the specification document or manuals published by the machine tool builder.

Unless otherwise specified, the following conditions apply in programming explanations and programming examples.

- Metric system for input and metric system for output / movement
- Zero point in the base coordinate system
- Reference point

Yaskawa has made every effort to describe individual functions and their relationships to other functions as accurately as possible. However, there are many things that cannot or must not be performed and it is not possible to describe all of these. Accordingly, readers are requested to understand that unless it is specifically stated that something can be performed, it should be assumed that it cannot be performed.

Also, bear in mind that the performance and functions of an PCNC machine tool are not determined solely by the PCNC unit. The entire control system consists of the mechanical system, then machine operation panel and other machine related equipment in addition to the PCNC. Therefore, read the manuals published by the machine tool builder for detailed information relating to the machine.

1

Outline of the YASNAC System

Chapter 1 describes the outline of the YASNAC system and the operating features and functions that should be thoroughly understood for the safe and efficient operation of the system.

1.1	Outline of the YASNAC System	1-2
1.1.1	System Configuration	1-2
1.1.2	Environmental Requirements	1-3
1.1.3	Machine Operation Panel	1-4
1.1.4	General Specifications	1-5
1.2	Protective Functions	1-9
1.2.1	Emergency Stop	1-9
1.2.2	Overtravel	1-9
1.2.3	Stored Stroke Limit.	1-10
1.2.4	Interlock Inputs.	1-12

1.1 Outline of the YASNAC System

1.1.1 System Configuration

 PCNC The configuration of the YASNAC PCNC system and the list of components are described below.

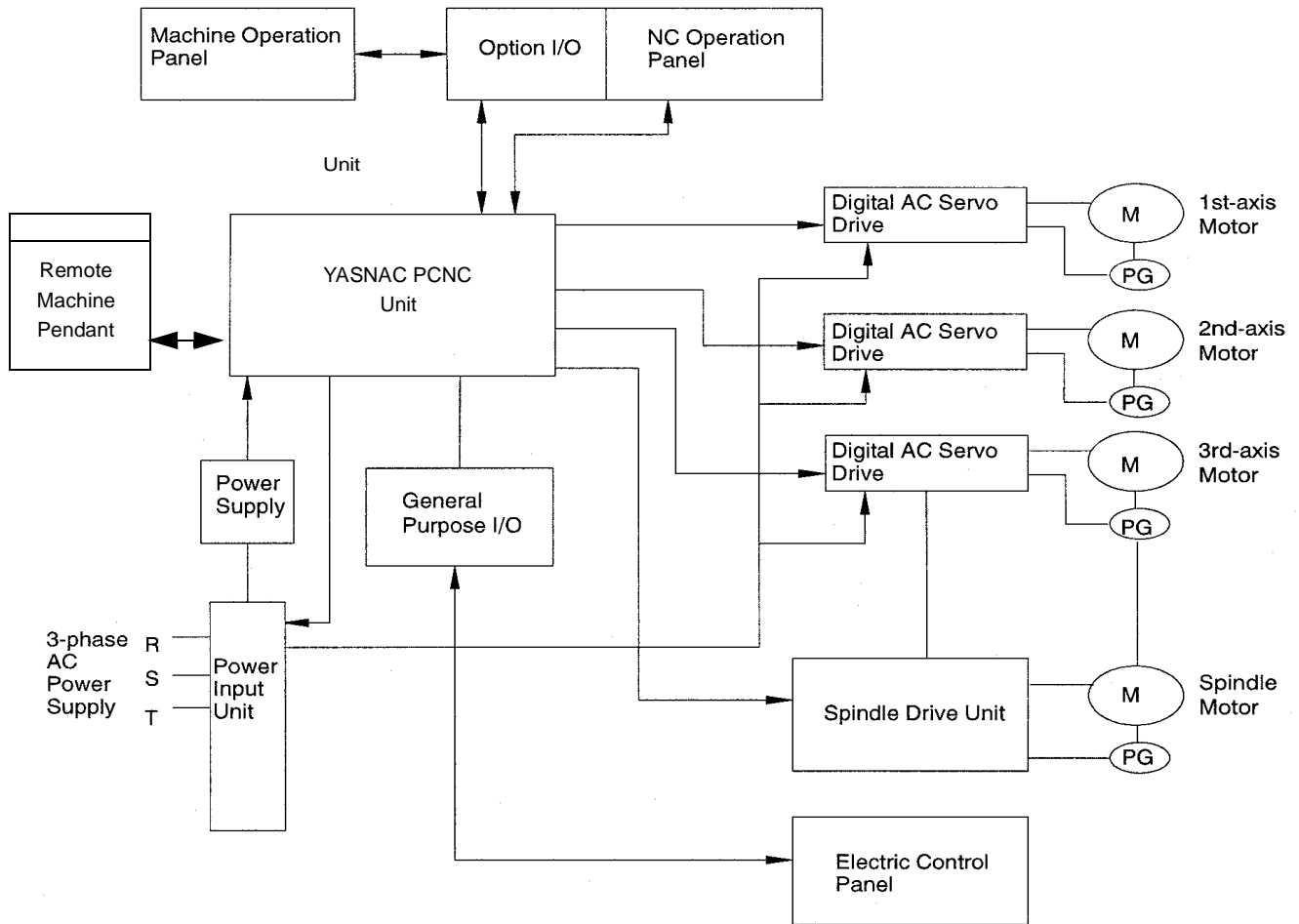

FIGURE 1.1.1.1: Standard Configuration of PCNC System

Table 1.1.1.1: List of YASNAC PCNC System Components

COMPONENT NAME	MODEL NAME
CPU rack	JZNC-JPCRKM-□-□□□□-□□
NC Operation Panel	JZNC-JCOP-□□□-□□
SERVOPACK	SGDC-□□
Spindle drive	CIMR-M5□□
Servomotor	SGM□-□□
Spindle motor	UAASKA-□□
Remote Pendant	TBA

1.1.2 Environmental Requirements

Requirements for the installation of an PCNC unit are indicated below. Install the PCNC unit in a location where only these requirements are satisfied to avoid possible malfunctioning.

CAUTION!

Avoid using it in an environment where it may be subject to high temperatures, high humidity, dust, corrosive gases, vibration or physical impacts that may cause fire, electric shock or malfunction.

- Use the product in an environment meeting the following conditions:
 - Free from gases or vapors that create a potentially explosive atmosphere.
 - Free from oil, organic solvents, etc.
 - Relative humidity in the range 10 to 90% RH, with no condensation.
 - Ambient temperature in the 0°C to 55°C with no freezing.
(Installation site must not be exposed to direct sunlight, must be distanced from heat generating devices, and must be indoors.)
 - Vibration not exceeding 4.9 m/s².
- Do not store the product in locations subject to rain, water droplets, harmful gases or liquids.

Failure to observe this caution may result in product failure.

- Select a storage area indoors that is clean and meets the following temperature and humidity requirements.

Ambient temperature: -15° C to 65° C (-5° F to 149° F)

Relative humidity: 10% to 90%

Failure to observe this caution may result in product failure.

(1) Ambient Temperature

For operation: 0°C to 55°C

For storage and transportation: -15° C to 65° C

Install the PCNC unit in a location not subject to direct sunlight, distant from heat sources, and indoors.

(2) Humidity

Relative humidity must be in the range of 10 to 90%RH (non-condensing).

(3) Vibration

During operation: Max. 4.9 m/s²

(4) Atmosphere

Avoid the following locations:

- Dusty places
- Places where concentration of coolant and/or organic solvent mist is extremely high.

(5) Power Source

Input voltage: AC (single-phase) 180V ~ 264V

Frequency: 50/60 Hz -2 to +2 Hz

1.1.3 Machine Operation Panel

An example of the machine operation panel is indicated below. Arrangement and names of switches and indicator lamps vary according to the machine model. For details, refer to the machine tool manual.

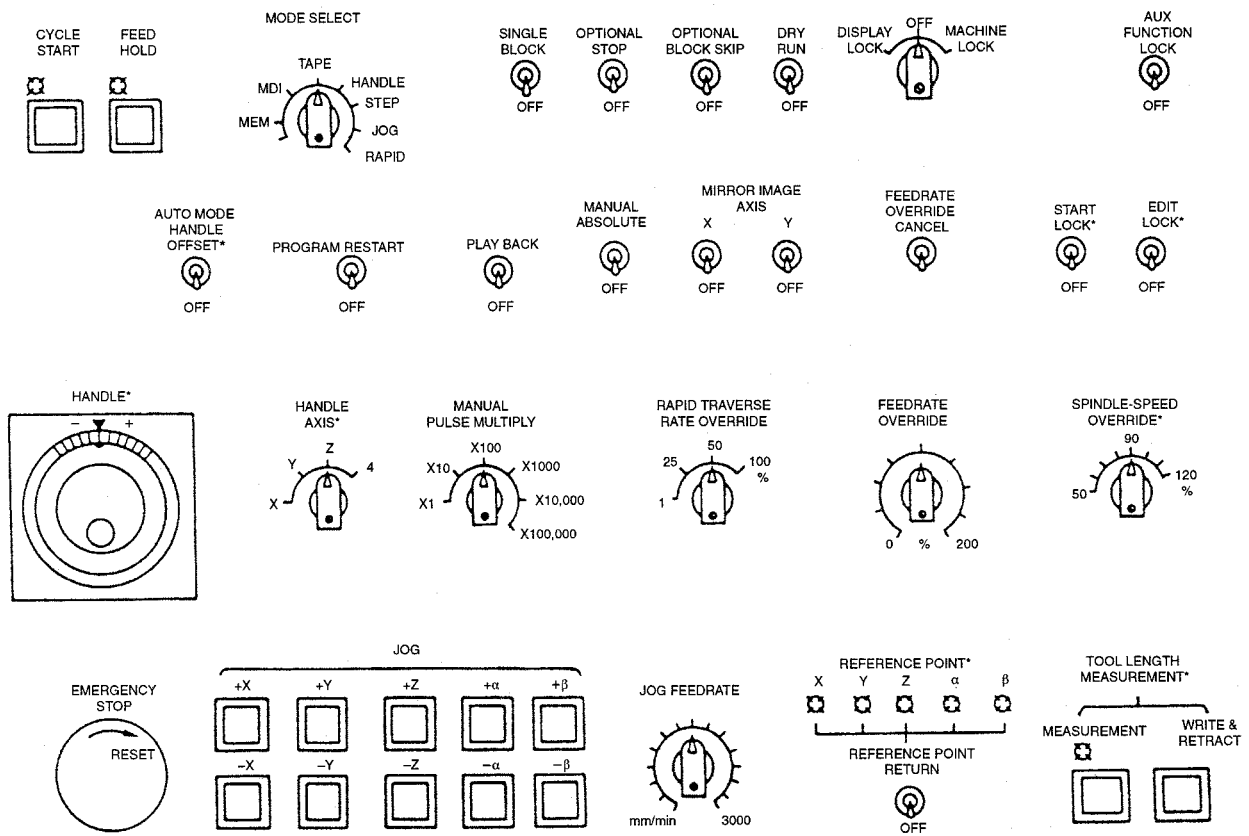

FIGURE 1.1.3.1: Example of Machine Operation Panel

1.1.4 General Specifications

(1) Standard Specifications

CATEGORY	ITEM AND FUNCTION	OPERATION MANUAL	PROGRAMMING MANUAL	SECTION NO.
Controlled axes	Controlled axes		✓	???
	Number of simultaneously controlled axes		✓	
Input command	Least input increment		✓	
	Least output increment		✓	
	Maximum programmable value		✓	
	Absolute/incremental programming		✓	
	Decimal point input		✓	
	Input unit 10 times		✓	
	Tape code		✓	
	NC tape		✓	
	Input format		✓	
	Buffer register		✓	
Interpolation	Positioning		✓	
	Linear interpolation		✓	
	Circular interpolation		✓	
Feed	Rapid traverse		✓	
	Cutting feed		✓	
	Dwell		✓	
	Incremental feed	✓		
	Automatic acceleration and deceleration		✓	
Storage and editing of program	Program storage capacity	✓		
	Number of programs		✓	
	Program editing	✓		
	Program number search	✓		
	Sequence number search	✓		
	Address search	✓		
	MDI editing	✓		
Operation and display	Operation panel	✓		
	MDI function	✓		
	1-line MDI	✓		
	Operation and display	✓		
	Calendar display	✓		
	Pop-up menu	✓		
	Buzzer function	✓		
Input/Output function	Input/Output interface	✓		

CATEGORY	ITEM AND FUNCTION	OPERATION MANUAL	PROGRAMMING MANUAL	SECTION NO.
Tool offset	Tool function		✓	
	Miscellaneous function		✓	
	Tool length offset		✓	
	Tool position offset		✓	
	Number of tool offset data sets		✓	
Coordinate system	Manual return to reference point	✓		
	Automatic return to reference point		✓	
	Automatic return to second reference point		✓	
	Reference point return check		✓	
	Return from reference point		✓	
	Base coordinate system setting		✓	
Operation support function	Label skip		✓	
	Single block	✓		
	Optional stop	✓		
	Optional block skip	✓		
	Dry run	✓		
	Machine lock	✓		
	Miscellaneous function lock	✓		
	Display lock	✓		
	Manual absolute	✓		
	Numerical value set-up	✓		
	Break-point function		✓	
	Operation mode	✓		
	Feed hold	✓		
Programming support function	Circular interpolation by R command		✓	
	Repetitive circle interpolation		✓	
	Subprogram		✓	
	Exact stop check		✓	
	Exact stop check mode		✓	
Safety and maintenance	Emergency stop input	✓		
	Overtravel	✓		
	Axis interlock	✓		
	Stored stroke limit	✓		
	Self-diagnostics (always displayed)	✓		
Environment requirements	Power supply	✓		
	Ambient temperature	✓		
	Humidity	✓		

(2) Option Specifications

CATEGORY	ITEM AND FUNCTION	OPERATION MANUAL	PROGRAMMING MANUAL	SECTION NO.
Controlled axes	Number of controlled axes		✓	
	Rotary axis control		✓	
Input command	Least input/output increment of rotary axis		✓	
	Inch/metric switching		✓	
	Multi-active registers		✓	
Interpolation	Helical interpolation		✓	
Feed	Synchronized feed (solid tap)		✓	
	High-speed mode operation		✓	
	F1-digit		✓	
	Simultaneous 1-axis handle feed	✓		
	Simultaneous 2-axis handle feed	✓		
	Simultaneous 3-axis handle feed	✓		
Storage and editing of program	Addition of program storage capacity	✓		
	Addition of number of programs		✓	
	Playback	✓		
Operation and display	Internal toggle switch	✓		
	NC program drawing	✓		
	Comment display function		✓	
Input/output function and device	Tape reader without take-up reels	✓		
	Tape reader with take-up reels	✓		
	RS-232C interface	✓		
Spindle, tool and miscellaneous functions	T4-digit command		✓	
	Second miscellaneous function		✓	
Tool offset	Tool radius offset		✓	
	Addition of tool offset data sets		✓	
Coordinate system	Manual second reference point return	✓		
	Automatic third/fourth reference point return		✓	
	Workpiece coordinate system setting		✓	
	Expanded number of workpiece coordinate systems		✓	
	Local coordinate system		✓	
	Rotation of workpiece coordinate system		✓	

Operation support function	Optional block skip B	✓		
	Automatic mode handle offset	✓		
	Program restart	✓		
	Automatic tool length measurement (TLM)	✓		
	Manual interruption point return	✓		
Programming support function	Canned cycle		✓	
	Canned cycle B		✓	
	Circle cutting		✓	
	Macroprogram		✓	
	Programmable mirror image		✓	
	Scaling		✓	
	Coordinate system rotation		✓	
	Automatic comer override		✓	
	Programmable data input		✓	
	Hole machining pattern cycle		✓	
Program copy		✓		
Accuracy correction for mechanical system	Stored pitch error compensation	✓		
	Unidirectional approach		✓	
Automation support function	Skip function		✓	
	Tool life control function		✓	
	Program interruption		✓	
Safety and maintenance	Stored stroke limit B		✓	
	Stored stroke limit C		✓	

1.2 Protective Functions

1.2.1 Emergency Stop

Press the emergency stop button immediately if a problem occurs with the system or line. The execution of all commands stops instantaneously when the emergency stop button is pressed. Servo power supply of the PCNC is shut OFF and dynamic brake is applied to stop all mechanical movement. In the emergency stop state, the PCNC is in the alarm state “3002”. If the emergency stop signal is “opened”, the PCNC stops the entire operation, and the SVMX and BKX signals are “opened”.



This operation is executed by setting the pins on the board. The pins differ between J300M and J100M.

Table 1.2.1.1: Emergency Related Signals

Signal Name	Pin Setting
Emergency Stop Input	CN12-19 pin on JZNC-JFC 10 board
SVMX	CN12-17 pin on JZNC-JFC 10 board
BKX	CN12-16 pin on JZNC-JFC 10 board

1.2.2 Overtravel

The overtravel function stops axis feed operation when an axis reaches the travel limit; for the detection of travel limit, a limit switch and a dog are used and if an axis reaches the travel limit, the limit switch outputs a signal and the function stops axis feed operation in response to this input. The axis reached and stopped at the travel limit can be moved manually into the axis movable range.

When the overtravel input is “opened”, axis movement is stopped in the manner as indicated in Table 1.3. In response to this input, the alarm output (ALM) is “closed” and the corresponding alarm message is displayed on the screen.

Table 1.2.2.1: Axis Stop Direction with Overtravel Input “Opened”

	Manual Operation Mode	Automatic Operation Mode
*+X to *+5 input is “opened”	Movement in the *+X to *+5 direction is stopped.	Movement of all axes is stopped in all directions.
*-X to *-5 input is “opened”	Movement in the *-X to *-5 direction is stopped.	

* Normally closed contact

If the overtravel input is “opened”, select the manual mode (jog, pulse handle) and move the axis in the direction opposite to the direction for which the overtravel input is “opened” to “close” the input. After that press the [RESET] key on the NC operation panel, the alarm output and display are canceled.

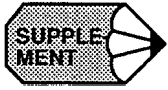

1. After the occurrence of an alarm due to the “open” of the overtravel input, the M, S, and T code read output signals (MF, SF and TF) are not turned OFF.
2. If it is necessary to interrupt the operation called by M, S and/or T code, set the interlock by an external sequence.
3. The alarm numbers at the occurrence of overtravel are 2001 to 2005. If the overtravel alarm occurs, axis move is stopped. Note that the servo is not turned OFF.

1.2.3 Stored Stroke Limit

To ensure improved safety in operation, this function prevents axis from entering the preset entry prohibited areas both in manual and automatic operation.

(1) Stored Stroke Limit

To use the stored stroke limit function, the axis movable area is set by parameters with the coordinate values in the machine coordinate system. The area outside the set boundary is established as the entry prohibited area. If an axis enters the entry prohibited area, the function stops axis movement and displays an alarm message. The function is made valid upon completion of the manual reference point return after the power is turned ON. In automatic operation, if even one axis causes the alarm, all axis are stopped.

In manual operation, only the axis that caused an alarm is stopped.

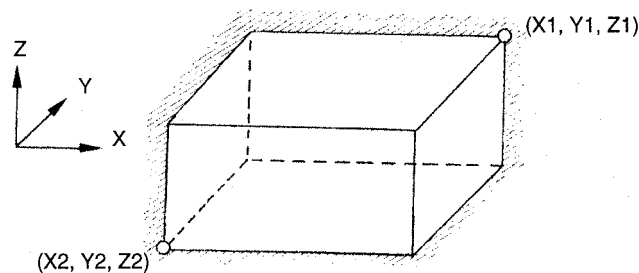

The outside is the entry prohibited area.

FIGURE 1.2.3.1: Stored Stroke Limit

(2) Stored Stroke Limit B, C (G22, G23) *

The area either outside or inside the boundary set by parameters or by the commands in a program is established as the entry prohibited area. The boundary is set with the coordinate values in the machine coordinate system. Whether the entry prohibited area is established outside or inside the boundary can be determined by the setting for a parameter. The function is made valid upon completion of the reference point return after turning ON the power.

Table 1.2.3.1: G Code Used to Turn ON/OFF the Stored Stroke Limit B Function

G CODE	FUNCTION	GROUP
G22	Turning ON the stored stroke limit B	04
G23	Turning OFF the stored stroke limit B	04

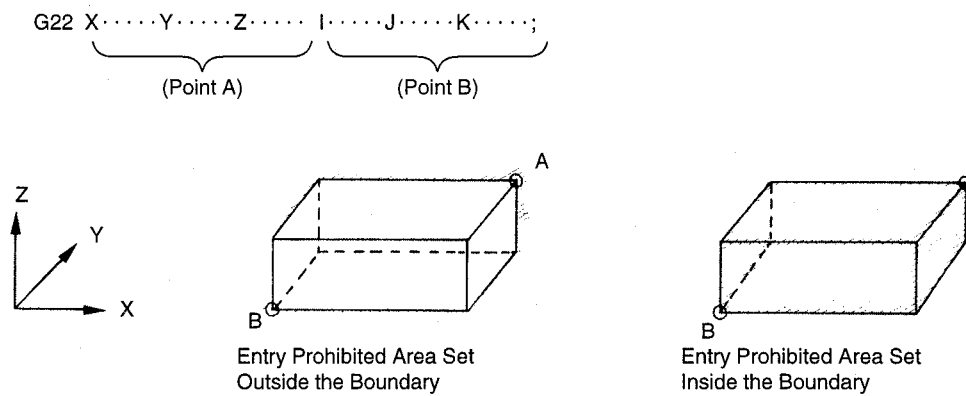

FIGURE 1.2.3.2: Stored Stroke Limit B Function

- In addition to the stored stroke limits A and B, stored stroke limit C can be added.
- With the stored stroke limit C, set the boundary of the area and inside or outside the boundary by parameters.
- According to the setting for the parameter or the input signal, one of the stored stroke limit C (third to fifth prohibited area) can be made valid.
- For details of the stored stroke limit B, C, refer to 4.2.3 “Stored Stroke Limit B and C (G22, G23)” in the PROGRAMMING MANUAL.

1.2.4 Interlock Inputs

The interlock input is the signal used to disable axis movement, and is provided for each axis.

- When an axis is interlocked during movement, it is stopped after deceleration.
- When the interlock is released, the axis continues moving to complete the remaining commands. Upon completion of the commands, the program advances to the next block.
- For simultaneous two or three axis interpolation commands, interpolation operation is disabled if one of these two or three axis is interlocked.

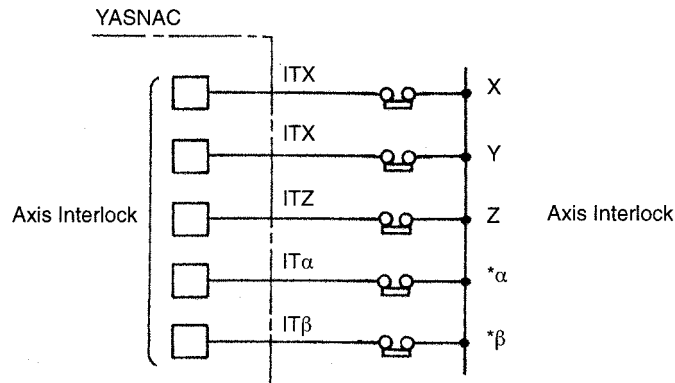

Fig. 1.6 Interlock Inputs

2

PCNC System Outline

Chapter 2 describes various operations including power ON procedure, manual operation and automatic operation.

2.1	General Operation Flow	2-4
2.2	Inspection before Turning the Power ON	2-5
2.2.1	Inspection of the PCNC unit	2-6
2.2.2	Preparation before Turning the Power ON	2-7
2.3	Turning the Power ON/OFF and Inspection after Power ON/OFF	2-8
2.3.1	Procedure for Turning the Power ON	2-8
2.3.2	Checking the Motors for Abnormalities	2-9
2.3.3	Procedure for Turning the Power OFF	2-9
2.3.4	Inspection of the Battery	2-10

2.4	Manual Operation (1)	2-12
2.4.1	Manual Rapid Traverse (RAPID)	2-12
2.4.2	Jog Feed (JOG)	2-13
2.4.3	Step Feed (STEP)	2-13
2.4.4	Handle Feed (HANDLE)*	2-13
2.5	Manual Operation (1)	2-13
2.5.1	Simultaneous 2- or 3-axis Handle Feed*	2-15
2.5.2	Manual Reference Point Return	2-16
2.5.3	Manual Reference Point Return to the Second Reference Point	2-18
2.5.4	1-line MDI	2-19
2.6	Automatic Operation (1)	2-20
2.6.1	Preparation of Automatic Operation	2-20
2.6.2	Memory Operation	2-22
2.6.3	MDI Operation	2-23
2.6.4	Feed Hold	2-23
2.6.5	Override	2-24
2.7	Automatic Operation (2)	2-24
2.7.1	Optional Stop	2-24
2.7.2	Optional Block Skip	2-24
2.7.3	Dry Run	2-26
2.7.4	Display Lock and Machine Lock	2-26
2.7.5	Auxiliary Function Lock	2-27
2.7.6	Z-axis Command Neglect	2-27
2.7.7	4th-axis Command Neglect	2-27
2.7.8	5th-axis Command Neglect	2-28

2.8	OPERATION INTERVENTION (during automatic operation).....	2-29
2.8.1	Manual Operation Intervention during automatic operation	2-29
2.8.2	MDI Operation Intervention during automatic operation.....	2-30
2.8.3	Automatic Handle Mode Offset	2-30
2.8.4	Manual Absolute.....	2-32
2.9	AUTOMATIC OPERATIONS AT ENHANCED LEVEL.....	2-34
2.9.1	Tool Length Measurement*	2-34
2.9.2	Return to the Operation Interrupted Point*	2-37
2.9.3	Manual Centering Operation*	2-37
2.9.4	Program Restart	2-38
2.9.5	Playback Function.....	2-44

2.1 General Operation Flow

The operation procedure usually followed for daily operation is indicated in Figure 2.1. This chapter explains these operation items.

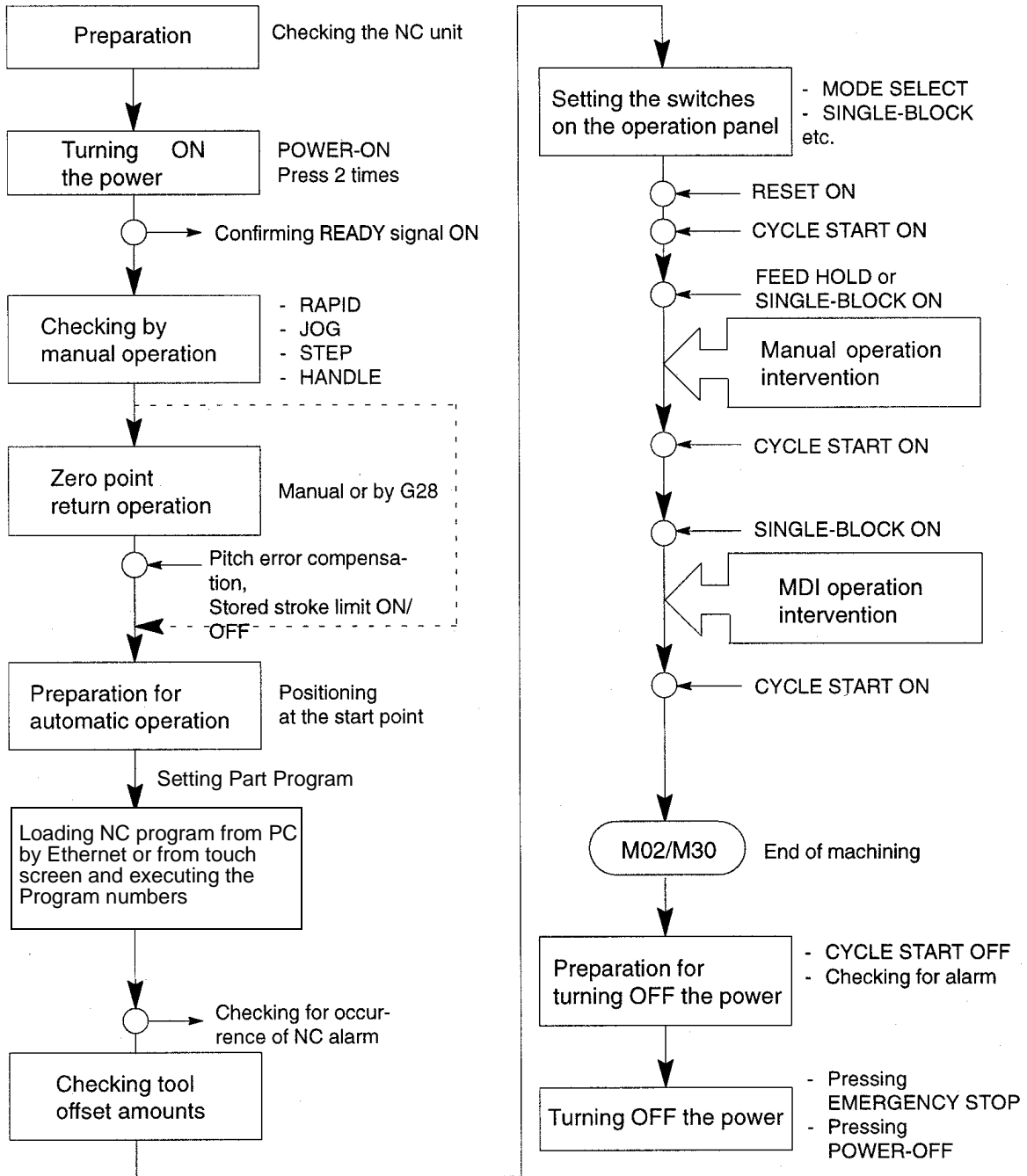

FIGURE 2.1.1: Operation Procedure

2.2 Inspection Before Turning the Power ON

Before turning the power ON for YASNAC PCNC, it is necessary to carry out inspection to Ensure safety. If the power is turned ON while the system has trouble, it could cause malfunctioning of the system itself and create a hazards conditions for the operations. Make sure to carry-out daily inspection before turning the power ON.

WARNING!

- Always turn all power OFF (including the primary power supply) before carrying out daily inspection.
Performing the inspection with the power ON may lead to electric shock.
- Wait 5 minutes after turning the power (including the primary power supply) OFF before removing or replacing any unit or part.
Failure to observe this warning could lead to electric shock and equipment failure.
- Do not touch any unit, terminals, etc., while the power is ON.
Failure to observe this warning could lead to electric shock or device malfunction.
- Immediately after switching the power OFF, the product retains some electric charge. Do not touch any parts (which are live when the power is ON) for 5 minutes after switching the power OFF.
Failure to observe this warning could lead to electric shock or device malfunction.
- Do not damage cables, subject them to excessive stress, or pinch them.
Excessive load on cables may cause electric shock.
- When the equipment is powered ON, never touch its rotating parts.
Failure to observe this warning could result in personal injury.
- Never modify the product.
Failure to observe this warning could result in electric shock, fire, or product failure.

CAUTION!

- To prevent personnel other than those involved in maintenance and inspection work from turning the power ON while maintenance and inspection is in progress, place signs stating **“DO NOT TURN THE POWER ON”** or words to that effect at the primary power supplies of related control panels and other relevant locations.
Failure to observe this caution could lead to electric shock.
- Electronic devices such as CMOS ICs are used on the control boards. If you touch the IC's with your bare fingers, static electrical charge in your body could destroy these IC's, care must be taken when handling these devices. Before handling these devices for maintenance purposes, first discharge the static electricity in your body by touching a grounded metal device.
Failure to observe this caution could lead to personal injury and product failure.
- Do not install or remove boards, wiring, connectors, etc., while the power is ON.
Failure to observe this caution could lead to electric shock, product failure, and malfunction.
- Do not let foreign matter such as electrical wire scrap enter the unit.
Failure to observe this caution could result in fire, product failure or malfunction.
- Be sure to check the following points after completing maintenance and inspection work:
 - Check that all fastening bolts are tightened.
 - Check that no tools or other objects have been left inside the control panel.
 - Check that the control panel door is closed properly.*Failure to carry out these checks could lead to electric shock, injuries, fire, and malfunction.*
- Never attempt to disassemble the NC unit modify units/devices inside the PCNC unit.
Failure to observe this caution could lead to fire, product failure and malfunction.
- Do not change the set values of the devices, variable resistors, etc., in the control panel.
Failure to observe this caution could lead to fire, product failure, and malfunction.

2.2.1 Inspection of the NC Unit

In this subsection, the items to be inspected before turning ON the power are indicated for the standard PCNC box supplied by Yaskawa. For the machine tool's control box, refer to the machine tool manuals.

(1) Inspecting the Machine Cabinet Doors

Make sure that the doors are securely closed before turning the power ON.
The PCNC CPU rack is not protected against oil mists or other airborne foreign matter.
The door of the machine cabinet doors must always be kept closed before powering ON.

(2) Inspecting the Shielding Parts in the Machine Cabinet

Inspect the shielding parts in the Machine Cabinet every month for gaps and/or damage.

- ① Open the doors and check the packings installed around the door for damage.
- ② Inspect the inside of the Machine Cabinet for abnormal contamination. If the inside is abnormally dirty, clean it immediately after locating the cause of contamination.
- ③ Lock the doors securely and inspect the doors to make sure that there are no gaps.

By carrying out the inspection procedures indicated above at regular intervals, the YASNAC PCNC can perform efficiently for a long time.

2.2.2 Preparation before Turning the Power ON

Before turning the power ON, confirm the following conditions:

- Make sure that the front side of the PCNC unit is closed. If the door is open or if there is a gap between the door and the box panels, securely close and lock the door.
- Carry out the inspection for the machine and machine related controllers according to the instructions in the machine tool manuals.

2.3 Turning the Power ON and Inspecting After Power ON

In this section, the procedure to be used for turning the power ON is explained. Inspection that must be conducted after turning the power ON is also described.

WARNING!

- Be sure to turn the power OFF before replacing the battery.

Failure to observe this warning could lead to electric shock and product failure.

CAUTION!

- Replace fuses and batteries with the recommended products.

Failure to observe this caution could result in fire or product failure.

- Use the product with the “System Number Switch” of the CPU set to “0”.

Using while set to another number could lead to malfunction.

- Wait at least 2 seconds after turning the power OFF before turning it ON again.

Failure to observe this caution could lead to malfunction.

2.3.1 Procedure for Turning the Power ON

Turn the power ON in the following sequence.

- ① Make sure that the power supplied to the PCNC unit is from an external power source.
- ② Press the POWER ON button on the NC operation panel. Control power is turned ON and the cooling fan starts rotating.
- ③ Make sure that air is flowing out at the upper part on the side of the NC unit.
 - In approximately 20 seconds, the control is ready for turning ON the servo power (alarm code 3000).
- ④ Press the POWER ON button again - one time.
 - The servo power is turned ON. When the machine is ready for operation, the NC enters the ready state.
 - When the power is correctly turned ON to the NC unit, the NRD (NC ready) signal is output.
 - When the power is turned ON at the machine side in response to the NRD signal, the MRD (machine ready) signal will be returned to the NC. The READY lamp goes on when the MRD signal is returned. Note that a READY lamp is not used with some types of machines.

- When the NC unit enters the ready state, the alarm message (displayed on the screen) will go off.
- ⑤ If the NC unit fails to enter the ready state, locate the cause by referring to Section 7.2, “ALARM DISPLAY JOB”, and take appropriate steps. For turning the power ON, there are items that must be inspected at the machine side in addition to the NC unit related items. For the former items, refer to the machine tool manuals.

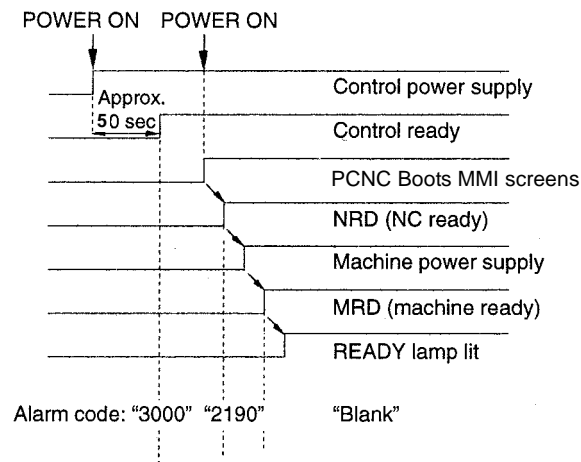

FIGURE 2.3.1.1: Power ON Sequence

2.3.2 Checking the Motors for Abnormalities

Check the operation of the motors running. If abnormal vibration or noise occurs, turn the power OFF and contact the maintenance personnel.

2.3.3 Procedure for Turning Power OFF

Turn the power OFF in the following sequence:

- ① Make sure that the CYCLE START lamp on the machine operation panel is OFF with the machine stopped.
- ② Make sure that there is no alarm message displayed on the CRT screen. If an alarm message is displayed, locate the cause by referring to Chapter 4, “MAINTENANCE” and take appropriate measures to clear it.
- ③ Carry out necessary STEPS for turning the power OFF at the machine side. For details, refer to the machine tool manuals.
- ④ Press the EMERGENCY STOP button on the machine operation panel to turn the servo power OFF. Press SHUTDOWN button to close all opened windows of PCNC.
- ⑤ When the safe SHUTDOWN message is displayed on CRT, Press the POWER OFF button on the NC operation panel to shut off the power to PCNC.

- ⑥ Turn the power supply to the NC OFF by turning OFF a circuit breaker, etc.

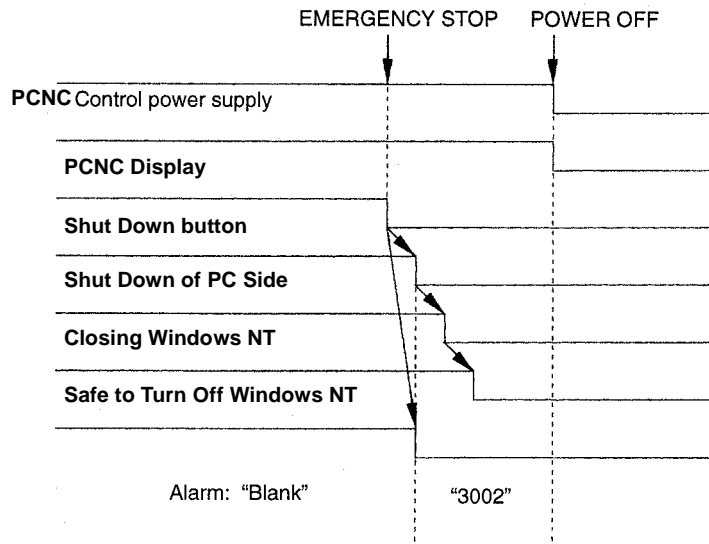
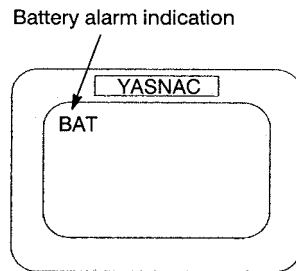

FIGURE 2.3.3.1: Power OFF Sequence

2.3.4 Inspection of the Battery

After turning the power ON, if there is a *battery alarm* , a *broken battery* icon will be displayed, or a *solid battery* is displayed to indicate everything is normal. After two minutes this normal battery indicator will disappear. When battery alarm is displayed by red battery icon, the battery must be replaced immediately. Standard batteries cannot be used. For a replacement of battery, contact your Yaskawa representative for Battery type: ER6VC3, Parts code: BA510



(1) Checking the Battery Which Needs Replacing

Follow the procedure indicated below to determine whether or not battery must be replaced.

- ① Press the POWER OFF button.
- ② If a door interlock switch is installed, place the door interlock key in the OFF position. This makes a power ON condition possible with the door opened.
- ③ Open the door so that the front part of the PCNC unit is visible.
- ④ Press the POWER ON button again - once.

- ⑤ Check the red color LED on the JANCD-JFC10 board. If it is lit, the battery must be replaced.

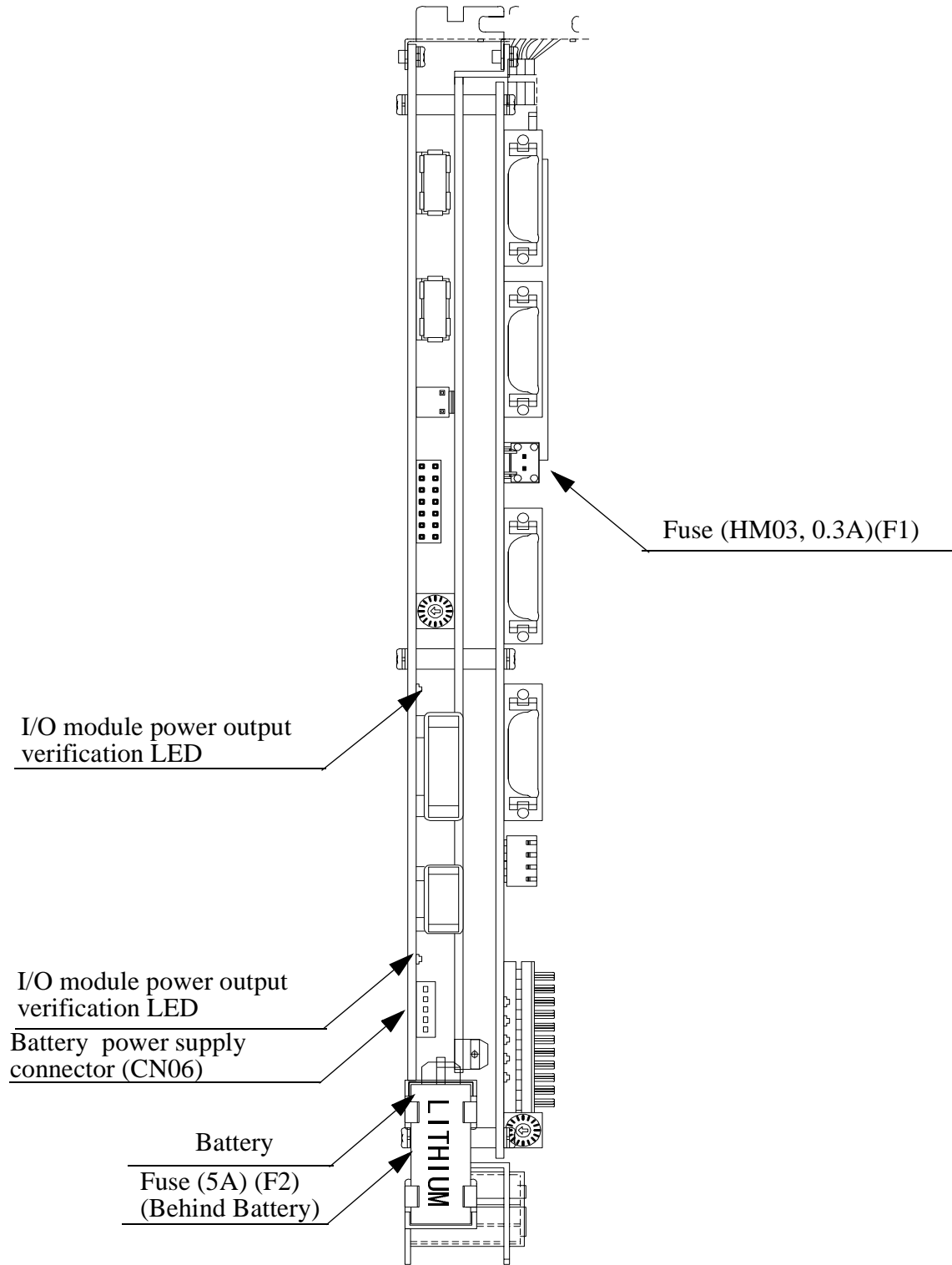

FIGURE 2.3.4.1: Location of the Battery on the PCNC board

2) Replacing the Battery

Replace the battery easily with the following procedure.

- ① Turn the PCNC power OFF.
- ② Remove connector of Battery. Then, remove the battery from the holder by desoldering.
- ③ Fit the new battery in the holder and carefully solder RED(+) and BLACK (-) wires to the Battery. Put the battery in its holder. Then put back battery connector, the connector may be inserted in either direction, it must be securely inserted, otherwise, the power will not be supplied by the battery. (See Fig. 2.7.)

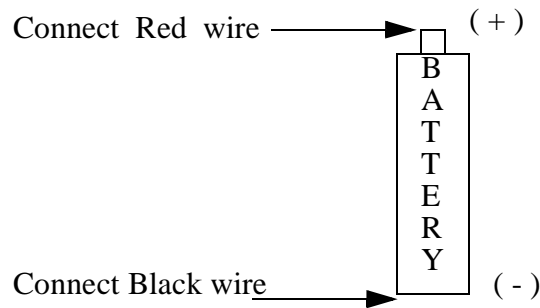

FIGURE 2.3.4.2: Connecting the Battery Connector

- ④ Turn the power ON.
- ⑤ Make sure that “BAT” is not blinking on the CRT screen, and that the red color LED in the board is OFF.



1. If the red color LED remains lit after replacing the battery, the connector might be inserted incorrectly or the battery might be faulty.
2. Power OFF operation is allowed a few seconds after turning the power ON.
3. After turning the power OFF, replace the battery quickly. If the PCNC unit is left with the battery removed, the data stored in the memory could be lost.

2.4 Manual Operation (1)

This section describes generally the manual operation. To move an axis manually, select the operation mode of RAPID, JOG, STEP, or HANDLE with the MODE SELECT switch on the machine operation panel.

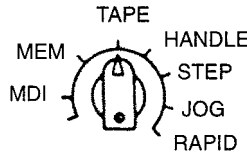

2.4.1 Manual Rapid Traverse (RAPID)

An axis can be moved at a rapid traverse rate. Follow the procedure indicated below.

- ① Select the rapid mode by placing the MODE SELECT switch on the machine operation panel in the RAPID position.
- ② Select the feedrate to be used for axis feed operation by the RAPID TRAVERSE and RATE OVERRIDE switch on the machine operation panel.
 - Override setting is possible in four steps of 100%, 50%, 25%, and F_0 . The feedrate corresponding to the setting at 100%, 50%, and 25% is set for parameters pm2801 to pm2805. For the setting at F_0 , feedrate set for parameter pm2447 is used.
 - Optionally, F_1 and F_2 positions are selectable. Feedrate to be selected according to the switch setting at F_1 and F_2 is set for parameters pm2448 and pm2449.
- ③ On the machine operation panel, press the JOG button that corresponds to the axis and the direction in which the axis should move. The axis moves at a rapid traverse rate while the button is held pressed.

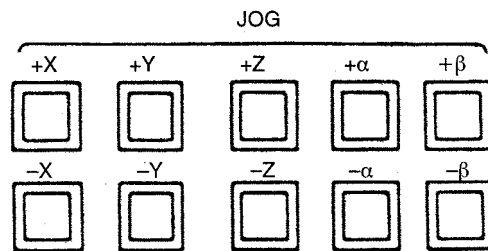

2.4.2 Jog Feed (JOG)

It is possible to move an axis in the jog feed mode. Follow the procedure indicated below.

- ① Select the jog mode by placing the MODE SELECT switch on the machine operation panel in the JOG position.
- ② Select the feedrate with the JOG FEEDRATE switch on the machine operation panel.
 - Feedrate can be selected from 32 steps, with actual feedrates of individual setting positions set for parameters pm2400 to pm2431. The actual number of steps and feedrates selectable by the JOG FEEDRATE switch vary depending on the machine model. For details, refer to the manuals published by the machine tool builder.
- ③ Press the JOG switch corresponding to the axis to be moved and the required axis move direction.
- ④ The axis moves at the selected feedrate while the JOG switch is held pressed.

2.4.3 Step Feed (STEP)

Manual step feed operation is possible. Follow the procedure indicated below.

- ① Select the step mode by placing the MODE SELECT switch on the machine operation panel in the STEP position.
- ② Select the feed distance per step with the MANUAL PULSE MULTIPLY switch on the machine operation panel.

Metric system : 0.001, 0.01, 0.1, 1.0, 10.0, 100.0 mm (per step)
Inch system : 0.0001, 0.001, 0.01, 0.1, 1.0, 10.0 inch (per step)
- ③ Press the JOG switch corresponding to the axis to be moved and the required axis move direction.
- ④ Each time the JOG switch is pressed, the selected axis moves in the selected direction by the set feed distance per step.

2.4.4 Handle Feed (HANDLE)*

When the NC is equipped with a manual pulse generator, pulse handle feed operation is possible. Follow the procedure indicated below.

- ① Select the handle mode by placing the MODE SELECT switch on the machine operation panel in the HANDLE position.
- ② Select the axis to be moved by the HANDLE AXIS selection switch on the machine operation panel.
- ③ With the MANUAL PULSE MULTIPLY switch on the machine operation panel, select the axis feed distance per pulse (one division of the pulse handle).

Clockwise rotation: In the positive direction

Counterclockwise direction: In the negative direction

Metric system: 0.001, 0.01, 0.1 mm (per division)

Inch system: 0.0001, 0.001, 0.01 inch (per division)

- ④ Turn the pulse handle. The axis moves in the positive or negative direction according to the direction in which the pulse handle is turned.

2.5 Manual Operation (2)

This section describes manual operations carried out in daily production using the manual operation functions explained in 2.4 “MANUAL OPERATION (1)”.

2.5.1 Simultaneous 2 or 3-axis Handle Feed *

By installing the pulse handle for the individual axis, it is possible to move up to three axis among the X-, Y-, Z-, α -, and β -axis simultaneously. Follow the procedure indicated below.

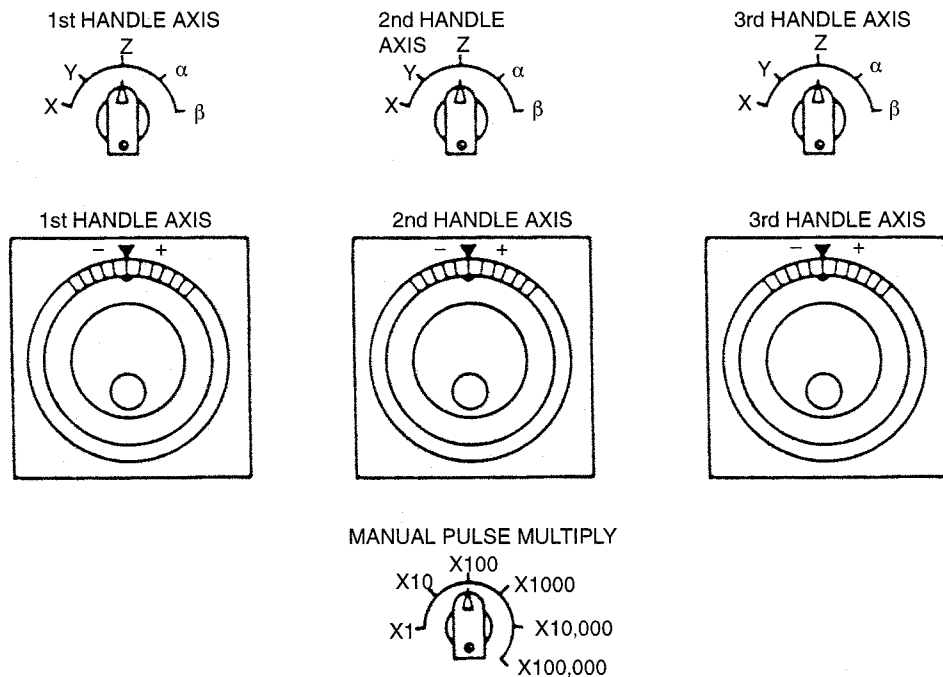

FIGURE 2.5.1.1: Simultaneous 2 or 3-axis Pulse Handle Feed

- ① Select the handle mode by placing the MODE SELECT switch on the machine operation panel in the HANDLE position.
- ② Select the axis feed distance per graduation of the pulse handle with the MANUAL PULSE MULTIPLY switch on the machine operation panel. This switch is used in common for the three pulse handles.
- ③ Turn the pulse handle. The selected axis is moved in the positive or negative direction according to the handle turning direction.

2.5.2 Manual Reference Point Return

Axes can be returned to the reference point in manual operation. Follow the procedure indicated below.

- ① Select the rapid or jog mode by placing the MODE SELECT switch on the machine operation panel in the RAPID or JOG position.
- ② Move an axis manually (manual rapid traverse or jog feed) to a position away from the reference point (within the reference point return enabled area). When an axis is located in range A in Fig. 2.9, reference point return can be executed correctly.
- ③ Turn ON the REFERENCE POINT RETURN switch.
- ④ Keep the JOG switch pressed corresponding to the axis returning to the reference point and in the return direction. When the JOG switch is held pressed, the corresponding axis starts moving in the same manner as ordinary manual axis feed operation. When the axis reaches the deceleration point, feedrate is decelerated to a low feedrate and the axis stops automatically at the reference point.
- ⑤ Upon completion of the reference point return, the REFERENCE POINT lamp of that axis lights.

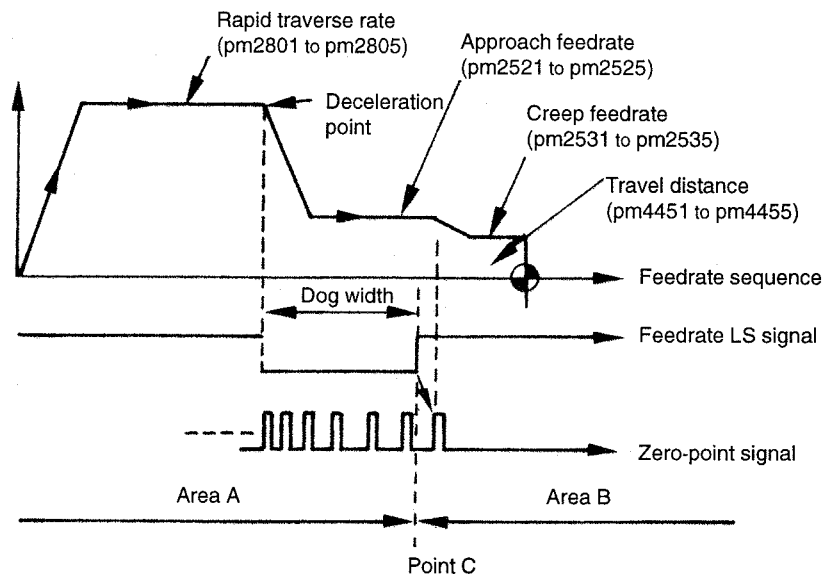

FIGURE 2.5.2.1: Manual Reference Point Return



◆ Reference Point is a specific position in the machine coordinate system. It is also called the machine zero point or the machine reference point.



1. Once the reference point return is completed, point C indicated in Fig. 2.9 is stored to the NC. Therefore, if reference point return is attempted while an axis is in area B, an error occurs. In this case, the axis should first be returned to area A and then the reference point return should be executed.
2. The axis for which the reference point return has been completed can be moved in

the reference point return direction manually only if the reference point return switch is turned OFF.

3. If commands have been read to the buffer area during automatic operation, manual reference point return must not be executed. If manual return operation is executed, the data in the buffer area is cleared.

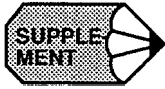

1. Immediately after the power is turned ON, the axis start manual or automatic reference point return operation independent of the present axis position. However, reference point return cannot be executed correctly if the axis is located in area B. In this case, the axis must be returned to area A before executing reference point return.
2. If the MODE SELECT switch setting is changed while an axis is moving automatically to the reference point, an alarm (alarm 2141 to 2145 reference point return interruption error) occurs.
3. Reference point return cannot be executed when the MACHINE LOCK switch is ON.
4. With a rotary axis, it is possible to execute automatic reference point return as with a linear axis. With a rotary axis, if it has been moved by more than $\pm 360.000^\circ$ from the reference point established first, reference point return is executed to the closest reference point in the preset direction of reference point return.

The illustration below shows how the reference point return is executed from points A and B. (The reference point return direction is determined by the setting for pm4002 D3 and D4.)

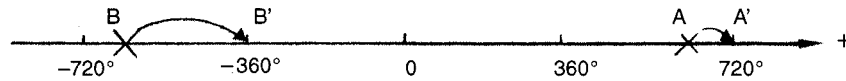

5. Once the reference point return is completed, second and later reference point return is executed at a high-speed mode. This is called “high-speed reference point return”. However, if the setting is so made to execute the reference point return at a low speed (pm4003 D6 = 1), second and later reference point return is executed at a low speed.

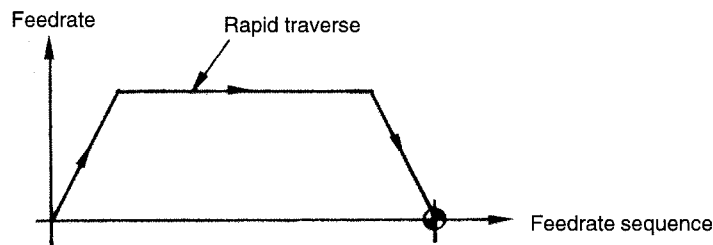

2.5.3 Manual Reference Point Return to the Second Reference Point*

The axis are automatically positioned at the second reference point. This operation allows positioning at the second reference point independent of the present axis position, whether it is in the negative side or positive side from the second reference position. Follow the procedure indicated below.

- ① Select the jog or rapid mode by placing the MODE SELECT switch in the JOG or RAPID position.
- ② Turn ON the ZRN2 (second zero point return request) switch on the machine operation panel.
- ③ Keep the JOG switch corresponding to the axis and direction of reference point return. The corresponding axis is positioned at the second zero point at the jog feedrate or rapid traverse rate according to the selected mode.
 - If the ZRN2 switch is turned OFF while an axis is moving to the second reference point, the axis stops moving. To restart the second reference point return operation, turn ON the ZRN2 switch and turn OFF the JOG switch having been pressed once, then press it once again.
 - If the JOG switch is pressed again to be turned OFF while the X-axis is moving to the second zero point, the axis stops moving. In this case, press the JOG switch again to turn it ON, and the X-axis restarts moving to the second zero point. With the Y- and Z-axis, this is also applied.



1. If the JOG switches of [+] and [-] are pressed at the same time, the corresponding axis stops moving since this operation is assumed to have turned OFF the JOG switch.
2. It is not allowed to use the first zero point return mode and the second reference point return mode at the same time. If both input signals are ON at the same time, both of the modes are invalid and neither jog nor rapid feed is executed. This feature is provided to ensure safety.
3. If the NC is in either the machine lock state (including the machine lock for individual axis) or the Z-axis command disregard state, the second zero point return operation cannot be executed. When a JOG switch is pressed under such a state, normal jog operation is preformed.
4. With the axis for which second zero point return has been completed, manual axis move operation is allowed only after the ZRN2 (second reference point return) switch is turned OFF.

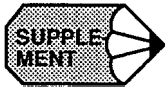

1. If the second zero point return input signal is turned ON in the state that the first zero point return has not been completed, the input is invalid and the second reference point return mode cannot be set.
2. In the second reference point return mode, input from the JOG switch [-X] ([-Y], [-Z]) is valid. If the mode is changed, the ZRN2 switch is assumed to have been turned OFF.

2.5.4 1-line MDI

During the execution of manual operation, it is possible to execute one block of a part program by directly entering it to the CRT screen. For this type of operation, a maximum of 40 characters can be written and the function codes that are allowed are M, S, T, F, and E codes.

However, M00, M01, M02, M30, M90 to M99, and M190 to M199 cannot be specified. An offset command with a T command is also disregarded. With the system that carries out set-up by using a T command, a T command must not be specified for this 1-line MDI operation.

Follow the procedure indicated below.

- ① Select the manual mode with the MODE SELECT switch on the machine operation panel. 1-line MDI operation is not possible in the automatic or edit mode.
 - ② Enter the program from the operation panel.
 - ③ Press the CYCLE START switch on the machine operation panel, and the entered program is executed. When the execution of the program is completed, the program displayed in the key entry display area is cleared.
- If the mode is changed while the program is executed (waiting for FIN), the FIN is not returned forcibly and the NC remains in the state waiting for the input of FIN.

2.6 Automatic Operation (1)

This section describes basic information necessary for performing automatic operation.

CAUTION!

- Before carrying out a cutting operation with a new program, confirm safety by performing the single block operation and dry run operation.

If this pre operational check is not performed, unexpected operation may result due to mis-setting of the amount of offset, leading to tool damage due to interference. The resulting interference may cause injury to personnel.

- Strictly observe the cautions in the user's manual when using programming functions.

Ignoring these cautions could lead to accidents involving injuries to personnel and malfunctions.

2.6.1 Preparation of Automatic Operation

After turning the power ON, the axis must be positioned at the start point defined in a program before starting automatic operation. Set the coordinate system to be used for machining either manually or by specifying appropriate commands in a program. Several examples are given below to explain how the coordinate system should be set. For details, refer to the machine tool manuals.

(1) Setting the Coordinate System

The origin of the coordinate system to be used for executing the commands should be set.

(a) When G92 is not specified in the program

The coordinate system for which the origin is set at other than the reference point for the program not containing the coordinate system setting command (G92) is called a coordinate system for machining. The procedure for setting a coordinate system for machining is indicated below.

- ① Return the axis to the reference point by following the manual reference point return procedure (see 2.4.2).
- ② Select the MDI mode by placing the MODE SELECT switch on the machine operation panel in the MDI position.

- ③ Write the program for setting the coordinate system.

For example,

G92X...Y...Z...;

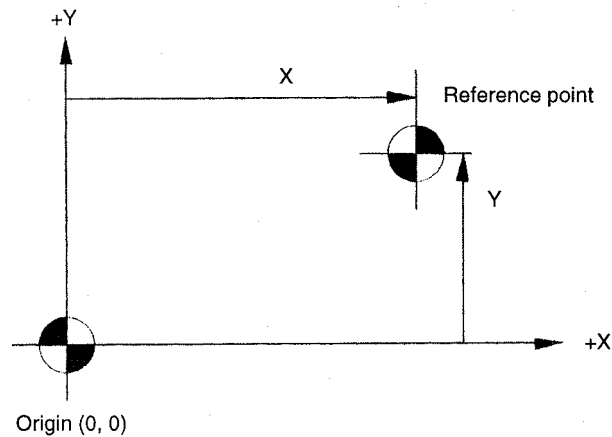

FIGURE 2.6.1.1: Coordinate System for Machining

- ④ Execute the program by pressing the CYCLE START switch on the machine operation panel.
- (b) When G92 is specified in the program, return the axis to the reference point by manual reference point return operation.

Example of Programming

EOR;

N1 G92X...Y...Z...;

- (c) When G28 (automatic reference program point return) and G92 are specified in the program, move the axis manually to a position (in the area where reference point return operation is allowed) away from the reference point.

Example of Programming

EOR;

N1 G28...Y...Z...;

N2 G92X...YO...Z...;

(2) Start Lock

Keep the machine in the start lock state until it is confirmed that machine operation is permitted. Follow the procedure indicated below.

- ① Before starting machine operation, turn the START LOCK switch on the machine operation panel ON.
- ② After safety is confirmed, turn the START LOCK switch OFF.

2.6.2 Memory Operation

Memory mode operation is used to carry out automatic operation by using programs stored in the PCNC memory. Follow the procedure indicated below.

- ① Make sure that the alarm icon on the PCNC MMI is green. If the alarm icon is red, touch the alarm icon button and locate the cause by referring to 9.1.4, “Cause of Alarm and Corrective Action” and take appropriate measures to clear it.
- ② Check the tool offset amounts and correct them if necessary, then position the axis at the start point. For details of tool offset, refer to 5.3, “TOOL DATA CONTROL JOB”.
- ③ Carry out necessary settings with the switches on the machine operation panel.
 - Select the memory mode by placing the MODE SELECT switch in the MEM position.
 - Set the SINGLE-BLOCK switch ON or OFF. To execute the program block-by-block, set it ON.
 - Set the rapid traverse rate with the RAPID TRAVERSE RATE OVERRIDE switch.
 - Set the MANUAL ABSOLUTE switch ON or OFF. Set the switch ON to return the tool by manual operation intervention to the previously located position.
 - Set the OPTIONAL BLOCK SKIP switch ON or OFF. Set the switch ON to disregard the blocks that include the “/” (slash) code.
 - Set the OPTIONAL STOP switch ON or OFF. To execute the optional stop function (M01), set the switch ON.
 - Set the DRY RUN switch. ON or OFF. Set the switch ON when checking the program.
 - With the FEEDRATE OVERRIDE and JOG FEEDRATE switches, set the feedrate.
- ④ Press the RESET button on the PCNC MMI operation panel. The program is rewound to the beginning.
- ⑤ Press the CYCLE START switch on the machine operation panel to start automatic operation.
- ⑥ To suspend operation temporarily, press the FEED HOLD switch on the machine operation panel.

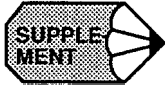

1. In case of emergency, press the EMERGENCY STOP button on the machine operation panel to stop the machine immediately.
2. It is possible to start a program half way in the memory mode operation. Locate the cursor at the required start block by using the Run This button, and press the CYCLE START button. For this operation, however, the modal G codes must be set before starting the program.
3. In the memory mode, address search must always be executed by specifying “address + neneral”.

2.6.3 MDI Operation

Automatic operation is possible by inputting a program in the MDI mode. Follow the procedure indicated below.

- ① Select the MDI mode with the MODE SELECT switch on the machine operation panel.
- ② Enter the block of commands from the keyboard. For details of program entry operation in the MDI mode, refer to 6.2, “MDI OPERATION JOB”.
- ③ Press the CYCLE START switch on the machine operation panel and the execution of the entered program is started.

2.6.4 Feed Hold

The feed hold function suspends automatic operation temporarily. Follow the procedure indicated below.

- ① When the FEED HOLD switch on the machine operation panel is pressed while an axis is moving, it stops after deceleration. The CYCLE START lamp on the machine operation panel goes OFF and the FEED HOLD lamp lights.
- ② After the completion of axis movement, the indicating lamp goes OFF.



1. If the execution of a drilling canned cycle is stopped halfway due to the single block function, the FEED HOLD lamp automatically goes ON to indicate that the operation is suspended during the execution of a drilling canned cycle.
2. The setting of the FEED HOLD switch is disregarded while a tapping cycle is executed in the G84 mode.
3. If the FEEL HOLD switch is turned ON while M, S, T, or B* function not associated to be completed although the FEED HOLD lamp lights immediately. After the completion

of the function, the FEED HOLD lamp goes OFF and operation stops.

2.6.5 Override

The following provides a general description of the override function. For details of override, refer to the machine tool manuals.

(1) Feedrate Override

In the automatic mode (TAPE, MEM, MDI), feedrate specified by an F code can be overridden in 21 steps in the range from 0 to 200% in increments of 10%, using the FEEDRATE OVERRIDE switch on the machine operation panel. During the execution of a tapping cycle (G74, G84), the setting is disregarded and the tapping cycle is executed in the feedrate specified by the program. If the OVERRIDE CANCEL switch is ON, the setting of the FEED RATE OVERRIDE switch is disregarded and the axis are moved at the feedrate specified by the F codes in a program.

Table 2.6.5.1: Feedrate Override Steps

STEP	%	STEP	%
0	0	11	110
1	10	12	120
2	20	13	130
3	30	14	140
4	40	15	150
5	50	16	160
6	60	17	170
7	70	18	180
8	80	19	190
9	90	20	200
10	100	-	-

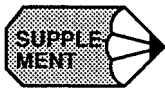

Optionally, feedrate override range can be expanded to 0 to 540% (32 steps). In this case, override increments are 10% in the range from 0 to 200%, 20% in the range from 220 to 300%, and 40% in the range from 340 to 540%.

2.7 Automatic Operation (2)

This section describes the switches used for automatic operation.

2.7.1 Optional Stop

The OPTIONAL STOP switch is used to select whether or not the M01 (optional stop) command should be executed in the automatic mode (MEM, MDI).

(1) OPTIONAL STOP Switch ON

When the OPTIONAL STOP switch is ON, the machine stops operating with the CYCLE START lamp on the machine operation panel lit after the execution of the block that includes M01. The CYCLE START lamp goes OFF if the FIN signal is returned. The operation restarts when the CYCLE START switch is pressed.

(2) OPTIONAL STOP Switch OFF

The M01 command is disregarded. If the OPTIONAL STOP switch setting is changed during the execution of an automatic operation, it is disregarded for the block presently executed. The new setting becomes valid from the block which is read after the switch setting has been changed.

2.7.2 Optional Block Skip

The OPTIONAL BLOCK SKIP switch is used to set whether or not the data in the block which includes the “/” (slash) code should be disregarded in automatic operation. Note that if the switch setting is changed during operation, the new setting is not valid for the blocks having been read to the buffer area.

(1) OPTIONAL BLOCK SKIP Switch ON

When the OPTIONAL BLOCK SKIP switch is ON, the commands specified after the “/” (slash) code are disregarded (up to the end of the block). For the blocks in which the “/” code is specified, the commands specified preceding the “/” code are executed.

(2) OPTIONAL BLOCK SKIP Switch OFF

The blocks which include the “/” (slash) code are executed. If the OPTIONAL BLOCK SKIP switch setting is changed during the execution of an automatic operation, it is disregarded for the block presently executed and also for the blocks having been read to the buffer area. The new setting becomes valid from the block which is read after the switch setting has been changed.

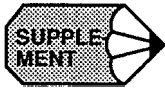

1. Specification of “/” is equivalent to”/ I“.
2. When the optional block skip 13 function is selected, the switches are provided corresponding to “/2” to “/9” individually and by using these switches, it is possible to turn ON and OFF the block skip function for the individual designation of “/2” to “/9”.

2.7.3 Dry Run

When automatic mode operation (TAPE, MEM, MD1) is executed with the DRY RUN switch set ON, feedrates specified in a program are disregarded and axis move commands are executed at the feedrate set with the JOG FEEDRATE switch. Since the F code specified in a program is displayed during the execution of a program, the program can be checked efficiently by using this function.

Feedrate to be used in positioning (G00) can be selected from the rapid traverse rate or jog feedrate according to the setting for parameter pm2000 D0 as indicated in Table 2.2.

Table 2.7.3.1: Rapid Traverse in Dry Run

Parameter pm2000 D0	G00 in Dry Run
“0”	Rapid traverse rate
“1”	Jog feedrate set with JOG FEEDRATE switch



1. When the setting of the DRY RUN switch is changed during automatic operation, the new setting becomes valid immediately. However, if it is changed while axis movement is controlled in the “mm/rev” mode” or during the execution of a tapping cycle, the new setting becomes valid after the completion of the presently executed block.
2. In the dry run mode, the setting of the RAPID ‘TRAVERSE RATE OVERRIDE switch is valid for rapid traverse operation.

2.7.4 Display Lock and Machine Lock

The DISPLAY LOCK/MACHINE LOCK switch allows the program to be executed in the following manner – to operate the machine with the present position data fixed, or to execute the program to update the present position data without actually operating the machine. The switch can be operated only while the operation is stopped in the block stop or feed hold state.

(1) DISPLAY LOCK/MACHINE LOCK Switch OFF

Select this position for normal manual or automatic operation. Both the machine and the position data are operated and updated according to the execution of the commands in the program.

(2) In the DISPLAY LOCK Position

The displayed position data are not updated even when the axis are moved. This position should be selected when the display data should not include the distance of shift.

(3) In the MACHINE LOCK Position

As the program commands are executed manually or automatically, the position data are updated according to the execution of the commands while the machine is not actually operated. With this setting, the M, S, T, and B* functions are executed normally.

This is used for manually presetting the display or for checking the tape. Note that the reference point return operation is not executed if the switch is placed in the MACHINE LOCK position. Auxiliary Function Lock

2.7.5 Auxiliary Function Lock

The AUX FUNCTION LOCK switch on the machine operation panel is used to check the NC tape in combination with the MACHINE LOCK function. When the switch is ON, the M, S, T, and B* function commands are disregarded. When the switch is turned ON during automatic operation, the function becomes valid from the block next to the presently executed block.

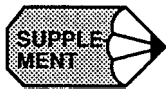

1. The M00, M01, M02, and M03 codes are processed normally.
2. Both the decode signal and BCD code are output. However, BCD code is not output with M90 to M99 (internally processed M codes); BCD code is not output inherently with these M codes.
3. The AUX FUNCTION LOCK switch setting is invalid for the S5-digit commands.

2.7.6 Z-axis Command Neglect

The Z-AXIS COMMAND NEGLECT switch is used to execute a program only in the XY plane. When the switch is ON, the program is executed with the machine lock function applied only to the Z-axis. Although the Z-axis does not move, position data of the Z-axis is updated as the program is executed. The switch can be operated only while the operation is stopped in the block stop or feed hold state.

2.7.7 4th-axis Command Neglect

When the 4TH-AXIS COMMAND NEGLECT switch is ON, the program is executed with the machine lock function applied only to the 4th-axis. Although the 4th-axis does not move, position data of the 4th-axis are updated as the program is executed. The switch can be operated only while the operation is stopped in the block stop or feed hold state. 5th-axis Command Neglect

When the 5TH-AXIS COMMAND NEGLECT switch is ON, the program is executed with the machine lock function applied only to the 5th-axis. Although the 5th-axis does not move, position data of the 5th-axis are updated as the program is executed.

The switch can be operated only while the operation is stopped in the block stop or feed hold state.

2.7.8 5th-axis Command Neglect

When the 5TH-AXIS COMMAND NEGLECT switch is ON, the program is executed with the machine lock function applied only to the 5th-axis. Although the 5th-axis does not move, position data of the 5th-axis are updated as the program is executed.

The switch can be operated only while the operation is stopped in the block stop or feed hold state.

2.8 Operation Intervention During Automatic Operation

This section describes the procedure used for manual and MDI operation intervention during automatic operation.

CAUTION!

- Do not restart automatic operation after stopping automatic operation and then performing “tool selection” in manual operation or “1 line MDI” operation.

The reason for this is that the “tool selection” operation may cause the coordinate system to be changed, leading to unexpected operation if automatic operation were restarted. This could cause tool damage due to interference and accidents causing personal injury.

Reset the NC after any manual intervention.

- After stopping automatic operation and performing a manual intervention, do not restart automatic operation without resetting first.

If automatic operation is started with the “mirror image” or “manual absolute” function in effect, unexpected operation maybe performed. This could cause tool damage due to interference, and accidents causing personal injury.

Reset the NC after any manual intervention.

2.8.1 Manual Operation Intervention during Automatic Operation

To carry out a manual operation during automatic operation, follow the steps indicated below.

- ① Interrupt the operation by using the FEED HOLD or SINGLE-BLOCK switch on the machine operation panel.
- ② Select the manual mode (RAPID, JOG, STEP or HANDLE) with the MODE SELECT switch on the machine operation panel.
- ③ Return the axes to the position where manual operation (see 2.3 “MANUAL OPERATION (1)”) has been started (the position recorded in step ②).
- ④ Return the MODE SELECT switch to the operation mode (MEM or MDI) position selected before manual operation intervention.
- ⑤ Press the CYCLE START switch on the machine operation panel to restart the interrupted automatic operation.

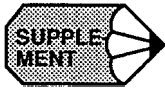

1. If the operation mode is changed from automatic to manual without stopping the operation, the axes are decelerated and stopped immediately. When the operation mode is changed from one automatic mode to another automatic mode, operation stops at the block end.
2. If automatic operation is restarted without returning the axes to the previously located position after manual operation intervention, how the tool paths to be generated after the restart of automatic operation differs depending on the setting of the MANUAL ABSOLUTE switch on the machine operation panel. For details of the switch, refer to 2.8.4, “Manual Absolute”.
3. In the manual mode, 1-line MDI operation is possible. For details of the operation, refer to 2.5.4, “1-line MDI”.

2.8.2 MDI Operation Intervention during Automatic Operation

To carry out an MDI operation during automatic operation, follow the steps indicated below.

- ① Interrupt the automatic operation by turning the SINGLE-BLOCK switch on the machine operation panel ON. The machine stops after the completion of the block being executed when the switch is turned ON. In this case, several blocks of commands might have been read into the buffer area.
- ② Place the MODE SELECT switch on the machine operation panel in the MDI position.
- ③ Enter the necessary commands.
- ④ Press the CYCLE START switch to execute the entered commands.
- ⑤ Return the MODE SELECT switch to the mode previously selected (MEM).
- ⑥ Turn OFF the SINGLE-BLOCK switch.
- ⑦ Press the CYCLE START switch to restart the interrupted automatic operation.

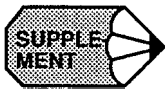

Do not attempt MDI operation intervention in a canned cycle mode (G73, G74, G76, IENT G77, G81 to G89) or during reference point return. Interrupted canned cycle or reference point return could not be completed correctly.

2.8.3 Automatic Handle Mode Offset *

During automatic operation (MD1, MEM), distance of axis shift carried out by using the pulse handle can be added by this function. This function allows compensation for errors in mounting workpieces, etc. Follow the procedure indicated below.

- ① Turn ON the AUTO MODE HANDLE OFFSET switch on the machine operation panel.
- ② Select the axis to be moved with the HANDLE AXIS switch on the machine operation

panel. If the simultaneous 3-axis control (by using the pulse handles) is selected optionally, simultaneous 3-axis operation is allowed.

- ③ Select the axis feed distance per graduation of the pulse handle by placing the MANUAL PULSE MULTIPLY switch on the machine operation panel at an appropriate position. By this switch, it is possible to select 1, 10, or 100 pulses per graduation of the manual pulse generator.
- ④ When the pulse handle is turned during the execution of automatic operation, movement of the axis which is selected in step② above is added to the axis move distance specified in the program. When the pulse handle is turned in the clockwise direction, the selected axis moves in the positive direction and when it is turned in the counter-clockwise direction, the axis, moves in the negative direction.
- ⑤ Restart the automatic operation after turning the AUTO MODE HANDLE OFFSET switch OFF. Succeeding operation is executed with the axis shifted by the pulse handle operation. When the coordinate system set-up command (G92, etc.) is executed after, the shift amount is not included, but the coordinate system is set according to the specified values.

Table 2.8.3.1: Setting Valid/Invalid for AUTO MODE HANDLE OFFSET

Axis	Parameter		Valid/Invalid
	Number	Setting	
X-axis	pm2002 D0 (HOFSX)	1	Valid
		0	Invalid
Y-axis	pm2002 D1 (HOFSY)	1	Valid
		0	Invalid
Z-axis	pm2002 D2 (HOFSZ)	1	Valid
		0	Invalid
4th-axis	pm2002 D3 (HOFS4)	1	Valid
		0	Invalid
5th-axis	pm2002 D4 (HOFS5)	1	Valid
		0	Invalid

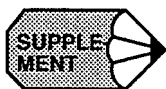

1. If the NC is in an alarm state or the interlock input (see 1.2.4.) is ON, it is not possible to move an axis by using the automatic mode handle offset function.
2. With parameter pm2003 D1, the condition necessary for moving an axis by using the automatic mode handle offset function can be set.
 - pm2003 D1 = 0: Enabled during both rapid traverse and interpolation operation
 - pm2003 D1 = 1: Enabled only during interpolation operation.
3. The manual absolute function cannot be used in this function.

2.8.4 Manual Absolute

If a cutting tool is moved manually by interrupting automatic operation, how the manually moved distance should be treated when restarting automatic operation can be determined by the setting of the MANUAL ABSOLUTE switch on the machine operation panel.

(1) MANUAL ABSOLUTE Switch ON

After the intervention of manual operation, the program coordinate system is not changed. Subsequently, the remaining commands in the interrupted block are executed by shifting from the programmed path when automatic operation is restarted. When the block appearing next to the operation restarted block is the circular interpolation block (G02, G03), circular interpolation is executed with the paths shifted from the programmed paths. When the G00 or G01 mode commands are given, the shift distance is canceled, and the paths return to the programmed paths.

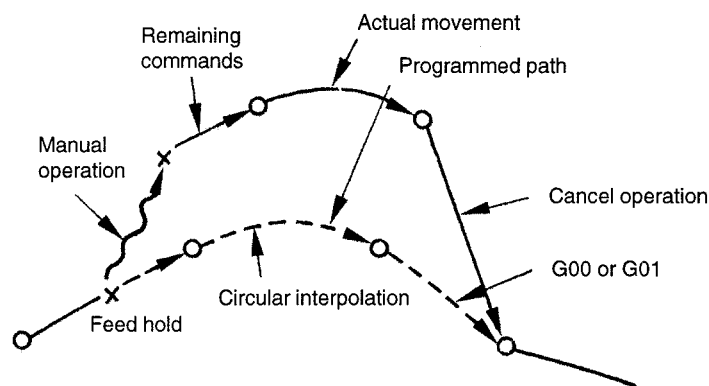
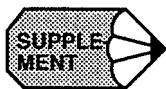

FIGURE 2.8.4.1: Operation with MANUAL ABSOLUTE Switch ON



By setting pm4011 D7, it is possible to make the manual absolute function valid when a program is executed in the G91 (incremental command) mode. In this case, the manual absolute function is called when the G90 (absolute command) is executed.

(2) MANUAL ABSOLUTE Switch OFF

If manual operation is executed by interrupting automatic operation, the program coordinate system is shifted by the manually shifted distance. Accordingly, when automatic operation is restarted, the program is executed in the shifted coordinate system.

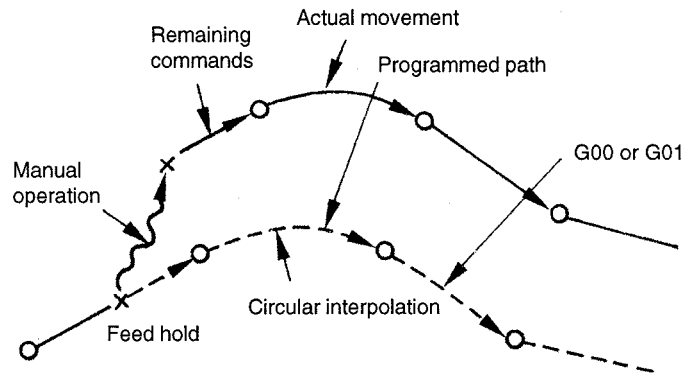

Fig. 2.12 Operation with MANUAL ABSOLUTE Switch OFF

The manually shifted amount is canceled by the following commands or operation in which the commands in the program are changed so that they agree with the present values.

- Manual or automatic reference point return
- Setting the base coordinate system
- Execution of skip (G31)
- Reset operation

3

HMI Process Operation

Chapter 3 describes the HMI process as related to the PCNC.

3.1 USER INTERFACE OVERVIEW.....	3-7
3.1.1 Status Bar.....	3-7
3.1.2 Battery Indicator.....	3-7
3.1.3 NC Execution Status.....	3-7
3.1.4 Motion Status.....	3-8
3.1.5 Alarm Message.....	3-8
3.1.6 Warning Message.....	3-8
3.1.7 Time/Date.....	3-11
3.1.8 Mode / MDI / Toolbar.....	3-11
3.1.9 Mode Indicator.....	3-12
3.1.10 Menu Bar.....	3-18
3.2 RECURRING COMPONENTS.....	3-19
3.2.1 Position Display.....	3-19
3.2.2 Program Display.....	3-20
3.2.3 Nest Level Display.....	3-21
3.2.4 Shortcuts.....	3-21
3.2.5 Number Field.....	3-22

3.2.6 File Browser	3-23
3.3 RUN MENU	3-25
3.3.1 Production Screen	3-25
3.3.2 Proveout Screen	3-27
3.3.3 NC Switch Screen	3-33
3.3.4 Timers Screen	3-34
3.4 PROGRAM MENU	3-36
3.4.1 File Screen	3-36
3.4.2 Editor Screen	3-42
3.4.3 List Screen	3-48
3.4.4 Macro Variables	3-51
3.5 TOOL MENU	3-53
3.5.1 Offsets Screen	3-53
3.5.2 Magazine Screen	3-55
3.6 SETUP MENU	3-57
3.6.1 Workshift Screen	3-57
3.6.2 Four (4) Positions Screen	3-58
3.6.3 One (1) Position Screen	3-59
3.7 UTILITIES MENU	3-61
3.7.1 Login Screen	3-61
3.7.2 PC Settings Screen	3-63
3.7.3 Maintenance Screen	3-65
3.7.4 Configuration Screen	3-66
3.7.5 Backup and Restore Screen	3-68
3.7.6 CPU Monitor Screen	3-70
3.7.7 Setting Parameters Screen	3-71
3.7.8 NC Parameters Screen	3-74
3.7.9 Machine Setup Screen	3-75

3.7.10 Pitch Error Screen	3-76
3.7.11 Solid Tap Screen	3-78
3.7.12 Torque Ripple Screen	3-79
3.7.13 Parameter Search Screen	3-80
3.7.14 High Speed Cutting Screen	3-82
3.7.15 User Install Screen.	3-83
3.7.16 MTB Install Screen	3-86
3.7.17 PLC Parameters Screen	3-87
3.7.18 PLC Diagnosis Screen.	3-88
3.7.19 Ladder Monitor Screen	3-93
3.7.20 Switch Label Screen	3-93
3.8 ALARM MENU	3-96
3.8.1 NC Alarm Screen.	3-96
3.8.2 PLC Alarm Screen.	3-97
3.8.3 Alarm History Screen	3-98
3.9 HELP MENU	3-100
3.9.1 MMI Map Screen.	3-100
3.9.2 Manual Screen	3-101
3.9.3 About Screen	3-102
3.10 OFF LINE MODE	3-103
3.10.1 The Offline Mode Interface	3-103

LIST OF FIGURES

FIGURE 1. Status Bar	3-7
FIGURE 2. Mode Indicator, MDI and Toolbar Areas	3-11
FIGURE 3. The Calculator Dialog	3-14
FIGURE 4. The Expanded Calculator Dialog	3-15
FIGURE 5. Menubar	3-18
FIGURE 6. Editing an Axis in a Position Display	3-19
FIGURE 7. Example of a Program Display	3-20
FIGURE 8. The Save As Dialog	3-24
FIGURE 9. The Run Production Screen	3-25
FIGURE 10. The Run Proveout Screen	3-27
FIGURE 11. 4 Views of the G-code Display Component	3-29
FIGURE 12. The NC Switch Screen	3-33
FIGURE 13. The Timers Screen	3-34
FIGURE 14. The File Screen	3-36
FIGURE 15. New Folder Dialog	3-38
FIGURE 16. Rename Dialog	3-39
FIGURE 17. The Editor Screen	3-42
FIGURE 18. The Replace All Confirmation/Status Dialog	3-44
FIGURE 19. Save As Dialog	3-46
FIGURE 20. New File Dialog	3-47
FIGURE 21. The List Screen	3-49
FIGURE 22. List Screen showing comments	3-50
FIGURE 23. Local Variables Tab of Program: Macro Variables	3-51
FIGURE 24. Common Variables Tab of Program: Macro Variables	3-52
FIGURE 25. The Tool Offsets Screen	3-53
FIGURE 26. Tool Offsets Error Message	3-54
FIGURE 27. The Tool Magazine Screen	3-55
FIGURE 28. The Setup Workshift Screen	3-57
FIGURE 29. The 4 Positions Screen	3-59
FIGURE 30. The 1 Position Screen	3-60
FIGURE 31. The Login Screen	3-61
FIGURE 32. The Change Password Dialog	3-62
FIGURE 33. The PC Settings Screen	3-63
FIGURE 34. The Maintenance Screen	3-65
FIGURE 35. Configuration Screen - NC Configuration	3-66
FIGURE 36. Configuration Screen - Drive Configuration	3-67
FIGURE 37. The Backup and Restore Screen	3-68
FIGURE 38. The Backup/Restore Status Dialog	3-69
FIGURE 39. The CPU Monitor Screen	3-70
FIGURE 40. The Setting Parameters Screen	3-71
FIGURE 41. The G-code Setting Parameters Screen	3-72
FIGURE 42. The Parameter Change Confirmation Dialog	3-73
FIGURE 43. The NC Parameters Screen	3-74
FIGURE 44. The Machine Setup Screen	3-75
FIGURE 45. Configuration Data Tab of the Pitch Error Screen	3-76
FIGURE 46. Axis Data Tab of the Pitch Error Screen	3-77
FIGURE 47. The Solid Tap Screen	3-78
FIGURE 48. The Torque Ripple Screen	3-79
FIGURE 49. The Parameter Search Screen with Drop-down Menus	3-80
FIGURE 50. The Parameter Search Screen with Text Search	3-81
FIGURE 51. The High Speed Cutting Screen	3-82
FIGURE 52. The User Install Screen Using Drop Down Menus	3-83
FIGURE 53. The User Install Screen Using Search	3-84

FIGURE 54.Install Dialog	3-85
FIGURE 55.The MTB Install Screen	3-86
FIGURE 56.The PLC Parameters Screen	3-87
FIGURE 57.The All Diagnosis Tab of the PLC Diagnosis Screen	3-88
FIGURE 58.The Display Selected Tab of the PLC Diagnosis Screen	3-90
FIGURE 59.The Force I/O Dialog	3-91
FIGURE 60.The Set Keep Memory Dialog	3-92
FIGURE 61.The Ladder Monitor Screen	3-93
FIGURE 62.The CNC Tab of the Switch Label Screen	3-94
FIGURE 63.The Machine Tab of the Switch Label Screen	3-95
FIGURE 64.The NC Alarm Screen	3-96
FIGURE 65.The PLC Alarm Screen	3-97
FIGURE 66.The Alarm History Screen	3-98
FIGURE 67.The Save Alarm History Dialog	3-99
FIGURE 68.The MMI Map Screen	3-100
FIGURE 69.The Help Manual Screen	3-101
FIGURE 70.The About Screen	3-102
FIGURE 71.The Offline Mode Screen	3-103
FIGURE 72.The Initialize CMOS Data Screen	3-104
FIGURE 73.The Update MMI Software Screen	3-105

LIST OF TABLES

TABLE 1. Possible Execution Status Values	3-7
TABLE 2. Possible Motion Status Values	3-8
TABLE 3. Common Warning Messages.....	3-9
TABLE 4. Possible NC Modes	3-12
TABLE 5. Parameters Affecting MDI Mode	3-13
TABLE 6. Arrow Colors in Program Displays.....	3-20
TABLE 7. M Codes.....	3-29
TABLE 8. G Codes	3-30
TABLE 9. Macro Lock Parameters.....	3-40
TABLE 10. Parameters Controlling O8000 - O8999	3-40
TABLE 11. Parameters Controlling O9000 - O9999	3-40
TABLE 12. Shortcut Keys	3-43
TABLE 13. User Levels Required for PC Settings Functions	3-63

3.1 USER INTERFACE OVERVIEW

The MMI is divided into several areas. At the very top is the status bar, which displays system status and alarm and warning messages. Below the status bar is the toolbar, which provides quick and easy access to commonly used functions such as copy and undo. The top level menu buttons and the Reset button appear at the bottom of the screen. Along the right hand side are the second level menu items and occasionally, shortcut buttons to other screens. The remainder of the MMI is what will be referred to as the screen. This area changes based on what is selected in the top and second level menus. This chapter provides a detailed description of these components.



3.1.1 Status Bar

The status bar occupies the top of the screen, and displays data pertaining to the state of the system, as shown in Figure 3.1.1.1 on page 7. It is split into sections that display the battery indicator, NC execution status, motion status, alarm message, warning message time and date.



FIGURE 3.1.1.1. Status Bar

3.1.2 Battery Indicator

At startup, if there is a battery alarm, a broken battery icon  is displayed. Otherwise, a solid battery  is shown to indicate that everything is normal. After two minutes, this normal battery indicator will disappear. If a battery alarm occurs, a red "Battery Alarm" message is displayed in the warning message area. If other warnings occur while the battery alarm exists, they will temporarily overwrite the battery alarm, but it will be redisplayed when they are cleared.

3.1.3 NC Execution Status

The execution status area (otherwise known as “Running status 1”) can have several values, as indicated by Table 3.1.3.1 on page 7.

Table 3.1.3.1: Possible Execution Status Values

Text Label	Meaning
STP	The NC is not executing
BUFn	The NC is in the n-block buffering status.
RST	NC is in reset status (Panel reset, Program reset, External reset)
PCHSC	PC High speed cutting mode
GHSC	GHSC form compensation mode

Table 3.1.3.1: Possible Execution Status Values

Text Label	Meaning
COR	G107 corner feed rate override mode
FH	Feed hold status
PRS	Program return search status
blank	Idle (none of above)

3.1.4 Motion Status

The motion status area displays information only when a program is running. Possible values are shown in Table 3.1.4.1 on page 8.

Table 3.1.4.1: Possible Motion Status Values

Text Label	Meaning
M	M code executing
S	S code executing
T	T code executing
F	Feed moving
RT	Rapid moving
B	B code executing
DWELL	Dwell executing
MAN-F	Manual interpolation
SAGR	Spindle speed agree signal waiting
CWAIT	C pulse waiting
blank	Idle

3.1.5 Alarm Message

When an alarm occurs, it is displayed in the alarm message area with black text on a red background. If there are multiple alarms, only the highest priority alarm is shown. To get more information about the currently shown alarm, or to see what other alarms may have occurred, use the Alarm button  to view the Alarm:NC Alarm screen.

3.1.6 Warning Message

When a warning occurs, the text is displayed here on a yellow background. Warning messages clear after 3 seconds. Warnings indicate a lower priority error which does not cause operation to stop. Some common warning messages are shown in “Common Warning Messages” on page 9.

Table 3.1.6.1: Common Warning Messages

INPUT ERROR!
O NO NOT FOUND!
NOT FOUND!
ALREADY IN!
OVER MEM CAP!
TOO MANY PROGS!
VERIFY ERROR!
MACRO LOCK!
LINE LOCK!
RUNNING PROGRAM!
NC IS RUNNING!
FORMAT ERROR!
IMPOSS COLLECT!
TOO MANY CHARS!
SETTING UNREADY!
EDIT LOCK!
NOT FOUND!
ALREADY EDITED!
SELECT MODE ERR!
COPY MODE ERROR!
MOVE MODE ERROR!
INPUT ERROR!
PRM SETTING ERR!
BIAS ERROR!
BOTTOM ERROR!
OFFSET ERROR!
H D ERROR!
CAN'T SET COORD!
OVER MDI BUFFER!
OVER MEM CAP!
RUNNING PROGRAM!

Table 3.1.6.1: Common Warning Messages

MACRO LOCK!
MEASUREMENT ERR!
TOO LARGE AREA!
FORMAT ERROR!
PROG NESTING ER!
ADDRESSING ER!
AXIS IS MOVING!
REPETITION ERR!
CAN'T WRITE!
RUN MODE ERROR!
AXIS ZR POS CMP!
AXIS IS MOVING!
NOT SET FOR ABS!
IN/OUT/VER LOCK!
NO ANSWER INTEX!
NO ANSWER MMON!
SET INVALIDITY!
EDIT INVALIDITY!
TORQUE LIMIT!
DRAWING!
NOT FOUND P NO!
ALREADY IN!
INSTR/OBSV!
DISCONNECT!
LADDER ROM NONE!
LADDER DATA NG!
C_MONI ERROR!
LADDER RUNNING!
PRM SETTING ERR!
ALREADY IN!
NC IS RUNNING!
BREAK POINT!

Table 3.1.6.1: Common Warning Messages

READING PROGRAM!
READING PROGRAM!
EDITING PROGRAM!
PRM WRITING ENABLED!
EXECUTING!
PLAYBACK LOCK!
RESTARTING PROG!
FSED MODE INVLD
CAN'T STORE FS!
CAN'T CHANGE FS!
CAN'T CLEAR FS!
FS STORE EXCEED!
START POINT!

3.1.7 Time/Date

Clicking on this area causes the display to toggle between time and date.

3.1.8 Mode / MDI / Toolbar

The Mode / MDI / Toolbar region, shown in Figure 3.1.8.1 on page 11, contains a CNC mode indicator, a text entry area for MDI mode, tool bar buttons for standard editing functions and screen navigation buttons.













FIGURE 3.1.8.1. Mode Indicator, MDI and Toolbar Areas

3.1.9 Mode Indicator



Possible modes are shown in “Possible NC Modes” on page 12.

Table 3.1.9.1: Possible NC Modes

Mode	Icon	Description
Rapid		Manual - can be used to move an axis at a rapid traverse rate. 1 line MDI works in this mode.
Jog		Manual - moves the axis at a selected feed rate while the Jog button is pressed. 1 line MDI works in this mode.
Handle		Manual - turning the pulse handle moves the selected axis. 1 line MDI works in this mode.
MDI		NC part program execution mode where commands are entered at the machine by the operator. Program size is 1KB maximum.
Mem		NC part program execution mode from PC memory such as HD/FD/ Network OR NC part program execution mode from CMOS memory on the NC board. The MDI command entry area is disabled.

The MDI single line command entry area is disabled in Mem  and MDI  modes, and will appear gray, as shown in Figure 3.1.8.1 on page 11. However, single line MDI data can be entered in the manual modes (Rapid , Jog , and Handle ). This is indicated by a white text entry area. Copy and Paste work in the single line MDI area, so text from G code programs may be quickly placed here for testing. Erroneous input is ignored.

Using single line MDI:

- Change to Rapid , Jog , or Handle  mode. The MDI text entry area will become enabled and change from gray to white.
- Touch the MDI text entry area. A flashing cursor will appear.
- Type in this program:

```
T01M06
```
- Press the cycle start button. The program is executed, and the text entry area is disabled during execution. The MDI area is cleared when execution is complete.

When the system is in MDI mode, multiple line MDI data can be entered in the program display area of both the Run:Production and Run:Proveout screens. Editing in the program display area is identical to editing in the Program:Editor screen. Several parameters affect how MDI mode behaves; these are listed in Table 3.1.9.2 on page 13. The contents of the MDI buffer are not lost when switching modes, so any text entered while in MDI mode should still appear when re-entering MDI mode. The white arrow indicates the line from which the program will be executed. If there is a blinking text cursor on that line, execution will start from the text cursor.

Table 3.1.9.2: Parameters Affecting MDI Mode

Address	Bit	Value	Result
3002	0	0	The MDI buffer is cleared if M02 or M30 is specified at the end of the MDI program.
3002	0	1	The MDI buffer is NOT cleared if M02 or M30 is specified at the end of the MDI program.
3002	1	0	External reset clears the MDI buffer.
3002	1	1	External reset does NOT clear the MDI buffer.
3002	2	0	Execution of the MDI program will start at the current cursor position.
3002	2	1	Execution of the MDI program will start at the beginning of the program.
4008	0	0	External reset causes the execution pointer to be rewound.
4008	0	1	External reset does NOT cause the execution pointer to be rewound.

 Clicking on the **Undo** button causes the last change made to a edit field on the currently displayed screen to be reverted to its previous value. There is a separate Undo/Redo buffer for each screen so when the user switches from a screen and back to it, the Undo/Redo history is maintained from the last time the screen was used. The Undo button is enabled as long as there is an action to Undo for the current screen.

 **Redo** becomes enabled once **Undo** is pressed. Clicking on “Redo” will complete the action that was just “Undone”.

 The **Calc** button pops a *Calculator* dialog, shown in Figure 3.1.9.1 on page 14, that appears at first in the middle of the screen. The calculator can be moved by pressing the **Move** button, then touching the desired location. On subsequent calls, it will pop where it was previously left. This dialog is not modal, meaning that the screen behind it can be used while the calculator is displayed. If the calculator is displayed but is not active, the blue buttons turn gray. The calculator can be dismissed by pressing the close button or by pressing the toolbar calculator button again. Numbers may be entered using the calculator’s keypad or the row of number keys on a standard keyboard. If **Num Lock** is set on the keyboard, the keyboard’s keypad may also be used for data entry.

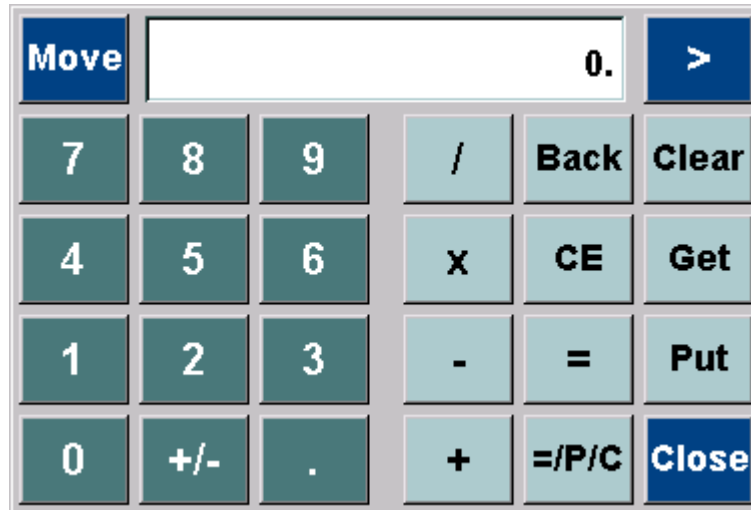

FIGURE 3.1.9.1. The Calculator Dialog

Besides the normal arithmetic functions, the calculator includes some special buttons for getting and putting numbers from the current number field. If the **Calc** button is pressed while in a number field the current number will automatically be placed in the calculator, ready for computation. The **Get** button may also be pressed to explicitly get the value from the current number field.

Results may also be written into the currently edited cell, by pressing the **Put** button. Pressing **=/P/C** performs the calculation, puts the result into the currently edited cell, and closes the calculator window.

Pressing the expand button (>) in the upper right corner of the screen will switch the calculator to its expanded version, shown in Figure 3.1.9.2 on page 15. If the expand button is pressed again, the calculator shrinks to show just the **Close** button, the display, and the expand button. When the expand button is pressed a third time, the calculator returns to its normal size.

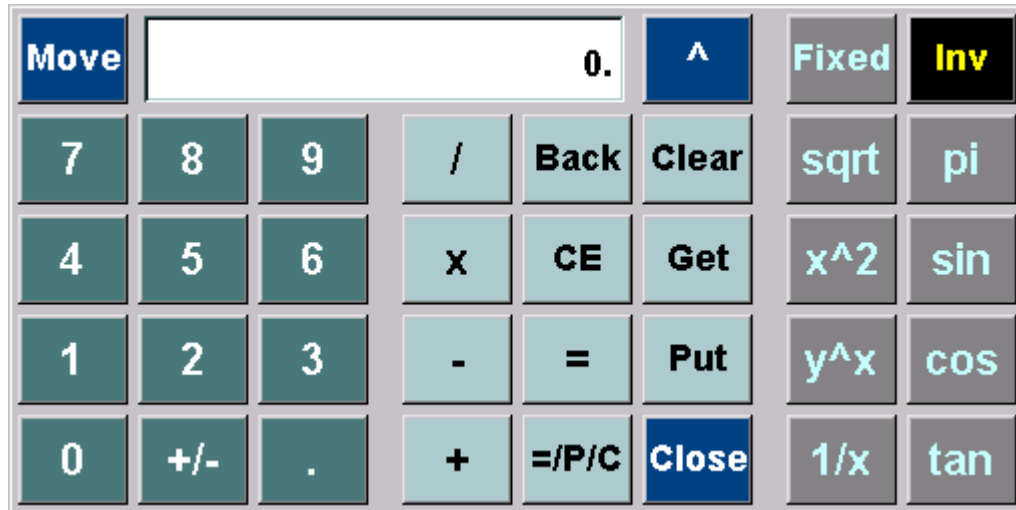



FIGURE 3.1.9.2. The Expanded Calculator Dialog

Incrementing a number:

- Select the number field that contains the number to be incremented.
- Display the calculator by pressing the **Calc** button .
- Pressing the + key, and then enter the increment amount.
- Press the **=/P/C** key. This will compute the result, put the result in the number field and close the calculator.

Raising a number to a power:

- Display the calculator by pressing the **Calc** button .
- Press the expand button (>) to enlarge the calculator and show expanded functionality.
- Enter "2." using the calculator's keypad. "2." is now shown in the display.
- Press the **y^x** button. A "^" appears in the lower left corner.
- Enter "3" using the calculator's keypad. "3" is now shown in the display. In the upper left corner there is a small "2.", and in the lower left corner there is a "^".
- Press the "=" button. "8." is now shown in the display.

Using the Get key:

- Change to the *Setup:Workshift* screen and select a cell in the grid. The border of the selected cell becomes a black line. Type in "7." and hit the **Enter** key. Touch outside the grid to deselect the cell.
- Display the calculator by pressing the **Calc** button .
- Enter "2." using the calculator's keypad. "2." is now shown in the display.
- Press the + button. A "+" appears in the lower left corner of the display.
- Enter "3" using the calculator's keypad. "3" is now shown in the display. In the upper left corner there is a small "2.", and in the lower left corner there is a "+".
- Select the grid cell with the value of "7.000" from the *Setup:Workshift* screen. The border of the selected cell becomes a black line.

- Press the **Get** button on the calculator. A "7." appears in the display of the calculator. A small "2." is still in the upper left corner, and a "+" appears in the lower left corner.
- Press the = button. "9." appears in the calculator's display, and the left corners are cleared. The "3" that was entered earlier was discarded.

Using the Put key:

- Display the calculator by pressing the **Calc** button .
- Enter "4." using the calculator's keypad. "4." is now shown in the display.
- Press the + key on the calculator's keypad. A "+" appears in the lower left corner of the display.
- Enter "5." using the calculator's keypad. "5." is shown in the display. In the upper left corner there is a small "4.", and in the lower left corner there is a "+".
- Select a grid cell in the *Setup:Workshift* screen. The border of the selected cell becomes a black line.
- Press the **Put** button on the calculator. "9." is shown in the calculator display, and "9.000" is entered into the grid cell, which has a yellow background because it is in edit mode.
- Press the + key on the numeric key pad. A "+" appears in the lower left corner of the display.
- Type "3." using the calculator's keypad. "3." is shown in the calculator display. In the upper left corner there is a small "9.", and in the lower left corner there is a "+".
- Press the **Put** button on the calculator. "12." is shown in the calculator display, and "12.000" is entered into the grid cell, which has a yellow background because it is still in edit mode.

Using the Fixed button:





- Display the calculator by pressing the **Calc** button .
- Press the expand button (>) to enlarge the calculator and show expanded functionality.
- Touch the **pi** key, which will show "3.141592653589793" in the calculator display.
- Touch the **Fixed** key to limit the number of digits shown after the decimal point. The display now shows "3.1416". Touch the **Fixed** key again to show more digits after the decimal.
- Touch the x^2 three times so that the display shows "9488.531016070572".
- Hit the **Fixed** key again. The display now shows "9488.5310".

 The **Help** button invokes the context-sensitive help pointer. To use it, click on the help button, then select the item for which help is desired. This will provide a short description of the function of the item. The description also includes a **Tell Me More** button which shows the corresponding section in the on-line manual.







 If the **Copy** button is clicked while some text or a number is selected, that data is stored in the windows system copy buffer. This works for all screens, even if the selected text is not editable. However, the copy button is disabled if the current selection can not be copied. Since it does not make sense to copy part of a number, when **Copy** is activated for a number the entire number is copied, regardless of what is selected.

-  Clicking on the **Paste** button will cause the contents of the windows system copy buffer to be placed in the selected area. **Paste** is disabled if the buffer is empty or the current selection can not be edited. Once an item is copied, it can be pasted multiple times.







Copying from a Program Display:

- Change to the *Program:Editor* screen.
- Touch inside the editor. This will enable the **Paste**  button.
- Select some text in the editor. This will enable the **Copy**  button.
- Press the **Copy**  button.
- Touch the **Search Up/Down** text field to select it.
- Press the **Paste**  button. The text from the program editor should now appear in the **Search** text field.

Copying from one screen to another screen:

- Change to the *Tools:Offsets* screen.
- Select a cell in the offsets grid. The border of the cell should turn black, and the **Copy**  and **Paste**  buttons should become enabled.
- Press the **Copy**  button.
- Change to the *Setup:Workshift* screen.
- Select a cell in the workshifts grid. The border of the cell should turn black, and the **Copy**  and **Paste**  buttons should become enabled.
- Press the **Paste**  button. The number from the tool offsets grid should now appear in the workshift grid. (To keep the original cell value, select another cell in the grid immediately after the copy.)

Copying from a position display:

- Change to the *Run:Proveout* screen.
- Select a number field in one of the position displays (the position does not have to be editable). The border of the number field in the position display is now black, and the **Copy**  button enables.
- Press the **Copy**  button. The selected number field looks the same.
- Select the search text field below the **Search Up**  button. **Copy**  is now disabled, but the **Paste**  button becomes enabled.
- Press the **Paste**  button. The number from the position display should now be displayed in the search text field.
- Delete the pasted text to return to the previous state.

-  The **Back** arrow will jump to the last screen shown, up to a maximum of 100. It is disabled if there is no previous screen.



The **Forward** arrow will go to the screen that is the next in the screen list. This is disabled if the user has never used the back arrow.

Using the Backward and Forward buttons:

- Change to the *Run:Production* screen.
- Change to the *Tools:Offset* screen. The **Back** button should now be enabled.
- Press the **Back** button on the toolbar. The *Run:Production* screen should now be showing, and the **Forward** button should be enabled.
- Press the **Forward** button on the toolbar. The *Tools:Offset* screen should now be showing, and the **Back** button should be enabled.

3.1.10 Menu Bar

The menubar contains the reset button and top level menu items. The latter will be discussed in subsequent chapters.

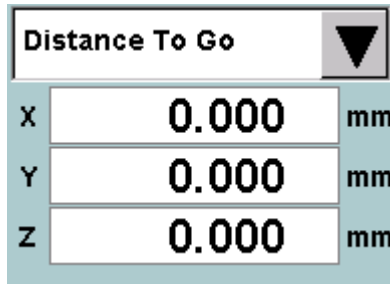

FIGURE 3.1.10.1. Menubar

/// The **Reset** button appears in the bottom left corner of the screen, just to the left of the top level menu. Pressing this button will halt NC operation and reset it to an idle state with the program counter back at 0. The running pointer arrow will appear at the top of the program display.

3.2 RECURRING COMPONENTS

3.2.1 Position Display



This component appears on several screens and can display a variety of coordinate systems: Machine, Workpiece, Measure, Distance To Go and Position Error. In some screens the coordinate system to display may be selected using the drop down selector. On other screens the coordinate system is fixed. Certain coordinates, such as Measure, are editable by clicking on an axis value. Editable position displays are only editable on the *Setup:4 Positions* and *Setup:Workshift* screens. Active editing is indicated by a yellow background as shown in Figure 3.2.1.1 on page 19.

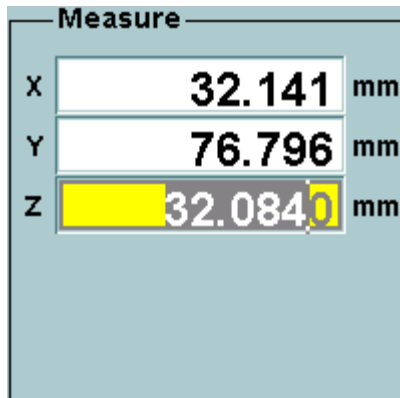

FIGURE 3.2.1.1. Editing an Axis in a Position Display

Editing is started by first selecting the field. At this point, position updating will stop. Pressing a number or the space bar next will start editing the number. This is indicated by the yellow background. Editing may be cancelled by pressing the escape key or committed by pressing the return key. The fields should only permit valid entries; otherwise they should revert to their previous values.

The Measure coordinates may be edited at any time. The Workpiece frame may only be edited in manual modes (Rapid, Jog, Handle and Step) when the machine is not running.

The current units are also displayed to the right of the numbers. If the units are millimeters then three numbers after the decimal are shown. If the units are inches then four numbers are shown to the right of the decimal point. Values may be positive or negative.

The position display supports showing up to 5 axes of position information. The number of axes displayed depends on the number of axes set in the parameter table.

3.2.2 Program Display

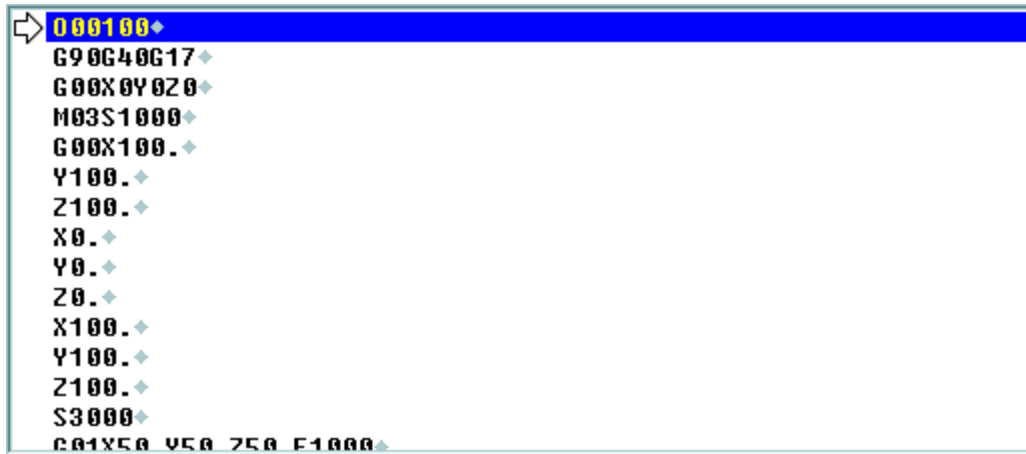

FIGURE 3.2.2.1. Example of a Program Display

The Program Display appears on the *Run:Production*, *Run:Proveout* and *Tools:Offsets* screens. When the program is running, the current line of execution is indicated by a blue highlight and a green arrow in the left margin. The white arrow indicates the line that would be executed if Cycle Start is pressed. The ◆ icon denotes the end of a block or statement, while the end of file is indicated by the ♦ icon. The → icon is shown at the beginning of a line that is continued from the previous line. There are two events which can change the position of the running pointer: searching in the *Run:Proveout* screen (when the running pointer arrow is white), or clicking **Run At Cursor** in the *Program:Editor* screen.

Table 3.2.2.1: Arrow Colors in Program Displays

Arrow Color	Meaning
Green	Program is executing. The current line of execution cannot be set by user.
Cyan	G-code is executing and the system is in MDI mode.
White	No program is executing. If the machine is in MEM mode, this indicates that the user can change the execution line via a search in the <i>Run:Production</i> screen or clicking Run At Cursor in the <i>Program:Editor</i> screen.

Positioning the Cursor:

- Create and save the following program:

```
O00007
N1G04P1.
N2G04P1.
N3G04P1.
N4G04P1.
N5G04P1.
N6G04P1.
N7G04P1.
N8G04P1.
N9G04P1.
M30
```

- Set the mode to Memory and start execution of O00007. The green arrow indicates the currently executing line.
- Select single block on the machine panel. Once the program stops executing, the arrow color will be white, and the arrow will be pointing at the next line to be executed. The sequence number for this line will be shown above the program display area.
- Switch to the *Program:Editor* screen and move the cursor to the desired new start position.
- Click the **Run At Cursor** button. The *Run:Production* screen will be shown, and the running pointer should indicate the newly specified starting line.
- Press cycle start. The next block to execute is the N4G04P1. block. The sequence number shows N4 initially, then changes to the next line (N5).

3.2.3 Nest Level Display

Program	L
O45982	

This display is useful if the program is executing nested sub-programs. There may be up to 8 levels of nesting, and the nest level is shown on the right. The program or subprogram name is shown on the left. The **Nest Display** toggle on the *Run:Proveout* screen controls whether this component is shown.

3.2.4 Shortcuts



Shortcut buttons provide a convenient way to jump between related screens. Shortcut buttons are displayed on the right side of the screen below a black bar containing a curved arrow icon.

3.2.5 Number Field

Editing is started by first selecting the number field. Pressing either a number or the space bar will start to change the number shown. This edit mode is indicated by a yellow background. Pressing the return key commits the new value. Pressing the escape key, or clicking outside of the field, will cancel any changes made.

The number field always shows one digit to the left of the decimal point, and four to the right (or three in metric mode), e.g., zero appears as “0.0000.” Typing digits without entering a decimal point causes the entered digits to shift in from the right (“0.0001,” then “0.0012,” then “0.0123,” etc.). When the decimal key is pressed, the previously entered digits will jump to the left of the decimal, leaving four zeros to the right.

The minus key acts like the change-sign key on a calculator. No matter when it is pressed, it always changes the sign of the current number.

Whenever the decimal key is pressed, a decimal is placed at the current insertion point. Any previous decimal disappears. If the decimal is pressed accidentally, pressing backspace will restore the previous one. In cases where an entered value is invalid (for example, if it’s out of some specified range) an error message will be shown once Enter is pressed.

Some instances of number fields can be found on the *Tools:Offsets* and *Setup:Workshift* screens. The following examples demonstrate the behavior of the number field.

Key Typed	What is Displayed
	0.0000
2	0.0002
3	0.0023
4	0.0234
5	0.2345
6	2.3456

Key Typed	What is Displayed
	0.0000
2	0.0002
3	0.0023
.	23. 0000

Key Typed	What is Displayed
4	23.4 000
5	23.45 00
.	2345. 0000
Backspace	0.2345
-	-0.2345
..	-0.234 5
..	-0.23 45
Backspace	-0.0245

Key Typed	What is Displayed
	0.0000
.	0. 0000
2	0.2 000
3	0.23 00
4	0.234 0
5	0.2345
6	0.2345

3.2.6 File Browser

Many screens in the user interface require a file to be selected from a directory. These screens use a file browser, which is a collection of components that can be used to change directories and select items within directories. While the implementation may differ slightly from screen to screen, there are some basic components that all file browsers share. The *Save As* dialog shown in Figure 3.2.6.1 on page 24 is duplicated here to serve as an example file browser. Instances of other file browsers are the tabs on the *Program:File* screen and the dialogs that appear when **New** or **Copy This** are pressed on the *Program:Editor* screen.

The file browser permits navigation to the files in the top-level directories shown in the **Save In** (or **Look In** or **Directory**) drop-down menu, and files in any subdirectories of the top-level directories. To change directories, first select the top-level directory using the **Save In** drop-down menu. Whenever a directory is selected, its contents are displayed in the file list area below the **Look In** drop-down menu. In the file list area, a sub-directory can be opened by highlighting the subdirectory to enter, then clicking on the **Open Folder**  button. To select a file, touch it to highlight it. The current directory name for the file browser may be displayed on some screens. Other screens, such as the *Save As* dialog, may also display the selected file.



When moving through a directory tree, it may be desirable to go back up to the parent directory. The **Up One Level** button is used to do this. When the current directory is a top-level directory, this button is disabled.

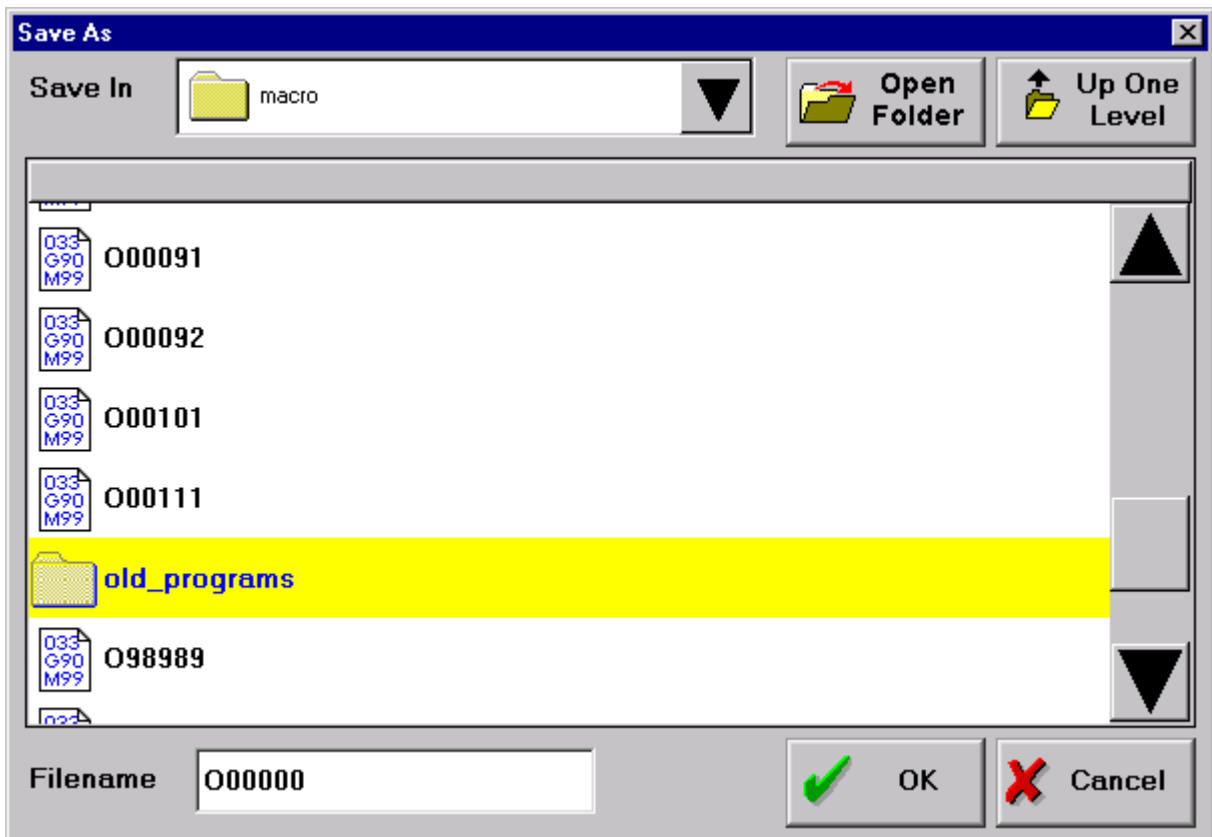

FIGURE 3.2.6.1. The Save As Dialog

3.3 RUN MENU

3.3.1 Production Screen

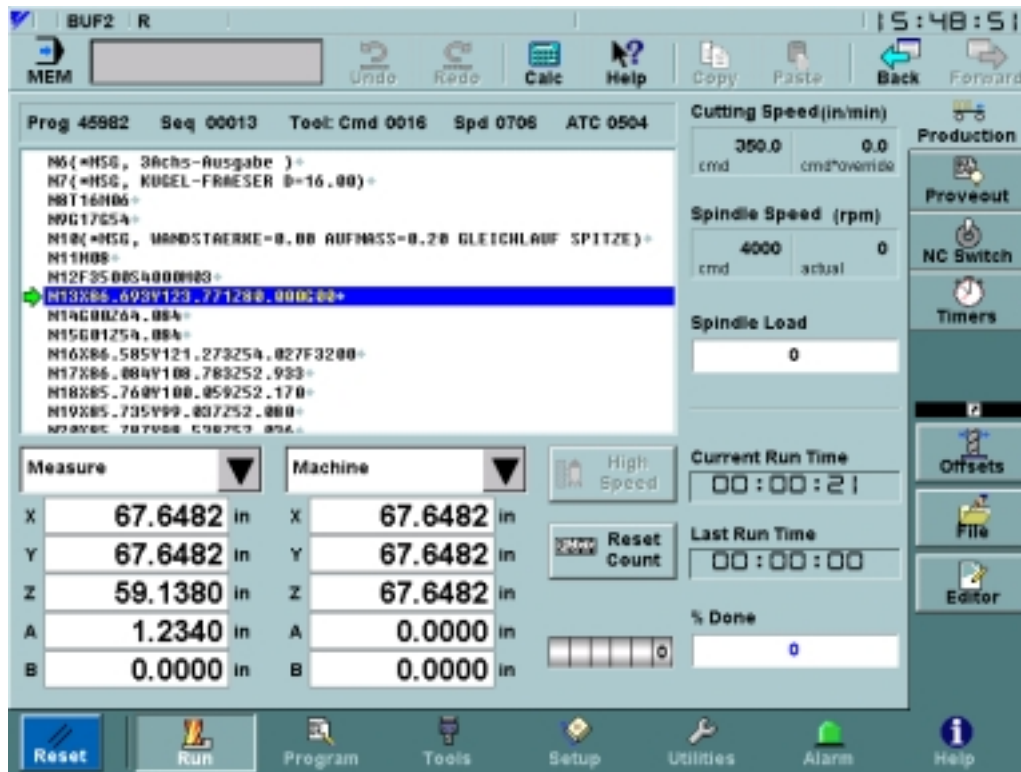

FIGURE 3.3.1.1. The Run Production Screen

This screen normally displayed during production. The screen includes a Program Display described in “Program Display” on page 20, two non-editable Position Displays, discussed in “Position Display” on page 19, and other production data. The choice of coordinate systems is preserved when the MMI is shut down so that at restart the same coordinate systems are displayed.

In the upper left corner of the screen is an area containing program-specific data. This data includes the current program, sequence number, Tool commanded, Speed and ATC tool numbers. The commanded tool number indicates the tool in use. The Spindle tool and ATC tool (tool currently held in the tool changer) are also shown.



The formatting of the tools is controlled by parameters, which is the way the Spindle and ATC tools are read.



Both the commanded cutting speed (F) and the commanded feed rate multiplied by the override are displayed. The commanded rate is the machine’s real cutting rate.

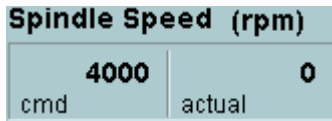

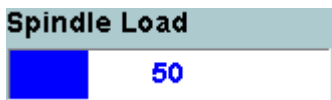

Both the commanded spindle speed (S) and the actual spindle speed are shown. The actual speed is the machine’s real spindle speed. Spindle speed units are rpm.



The **Spindle Load** bar indicates the current load as a percentage of the maximum allowed value. If the load meets or exceeds 100, then the bar changes from blue to yellow. If the load exceeds 140 then the color changes to red. Spindle load can vary from 0 to 200%.



A toggle button is provided to turn high-speed mode on. High-speed mode selection may only occur when the machine is not running and it is in MEM  mode. High-speed mode may be exited any time the machine is not running. High speed mode is indicated by

a change in the rocket icon: 

Production data includes the current run time, the last run time, the percentage of the last run time as given by the current run time and the number of parts done.



Current Run Time is the time taken by the CNC from start of first block in the part program until the completion of the last block in the part program. The run time information is intended to indicate to the operator how much time is left before manual intervention is required. After a program has been modified, **Last Run Time** is reset. It is also reset when the current program changes. If the reset button is pressed while the program is running, the **Current Run Time** is set to zero, but the **Last Run Time** will not be

affected.

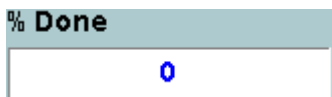

%Done is disabled for the first run of a part. It is also disabled if the program has been edited since the last run, since the cycle time will no longer be valid.



Part count is stored in keep memory. The indicates how many times the current part program has been successfully completed.



The **Reset Count** button is used to set the part counter back to zero.

3.3.2 Proveout Screen

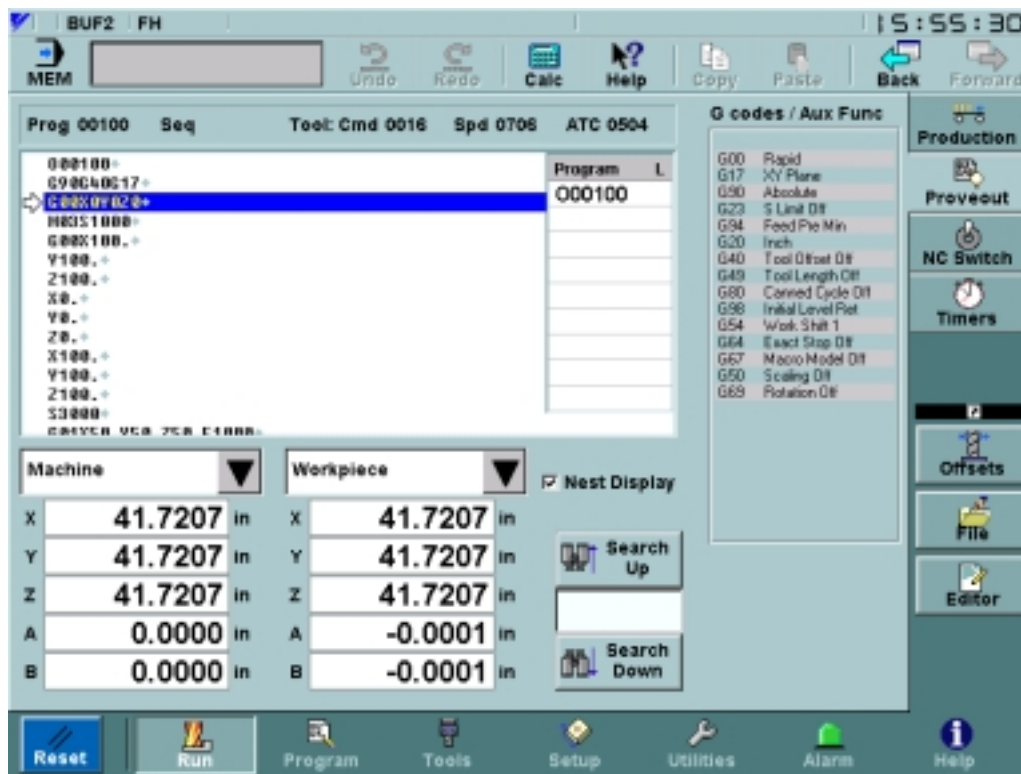

FIGURE 3.3.2.1. The Run Proveout Screen

The *Run:Proveout* screen is intended to be a tool used by setup personnel to test and adjust a program before it is used in production. It contains many of the same components as the standard production screen, discussed in “Production Screen” on page 25. The additional components in this screen are discussed below.

If the program is executing nested sub-programs, the lowest level program is shown. There may be up to 8 levels of nesting. The **Nest Display** toggle controls whether the program call stack is shown. The nest level component is presented in “Nest Level Display” on page 21.





The search field is used to specify a string to be found. Clicking on either the **Search Up** or **Search Down** button will jump to the next occurrence of the string in the current file, and the matching area will be highlighted in reverse video. The search is case-sensitive. Searching will commence from a highlighted search match or the currently executing line if no match is highlighted. If neither of these is present, the search will start from the first line of the program. When no more matches are found in the search direction, a “String not found” warning is shown.

Using Search to set the running pointer:

- Switch to the *Program:Editor* screen and create this program:



```
O00002
X1
X2
X5Y5Z5
X6
X7
X10
M30
```

- Set to Memory  mode. Press the Run; this  button on the *Program:Editor* screen to set the new program to be the current program.
- Go to the *Run:Proveout* screen. Type “Y5” into the search text field and press the **Search Down**  button. The running pointer will move to the line “X5Y5Z5”, which will be shown in blue. The matching text will be displayed in reverse video.
- Press cycle start - once to execute the program. The starting point for execution is the *beginning* of the text that is matched (i.e., the “Y5” command is the first to be executed).
- Note: Care must be taken when choosing the string for which to search. If the search in this example had been for just “5” instead of “Y5”, then the program would have tried to start executing at “5”, causing an “Address/Data Error”.

Editing the currently executing program:

- Switch to the *Program:Editor* screen and create this program:

```
O00001
G04P100.
M30
```

- Set to Memory  mode. Press the Run; this  button on the *Program:Editor* screen to set the new program to be the current program. Turn on single block mode.
- Press cycle start once to execute the first line of the program.
- Switch to the *Program:Editor* screen to enable editing. A gray status bar at the bottom of the program display area will show “Cur” to indicate that the current program is being edited.
- Change O00001 to this:

```
O00001
G04P10.
M30
```
- Position the text cursor at the beginning of the G04 line. Touch the Run At Cursor button. The Run:Production screen will be shown once again.
- Hit cycle start once. The NC will execute a 10 second dwell instead of a 100 second dwell.

The **G codes/ Aux Func** display changes its appearance each time it is touched. The default view shows active non-modal and modal (groups 1 -23) G codes. A list of all G codes is shown in Table 3.3.2.2 on page 30. Placeholders for non-modal G codes are blank unless the CNC executes the code. Each modal G code is followed by a short description. The next view shows com-

mand values, such as the commanded Feed, Speed ,current H and D tool offsets. The subsequent view displays both G codes and commanded values. The final view is active M codes followed by short descriptions. A list of all M codes is shown in Table 3.3.2.1 on page 29. This sequence of views is illustrated by Figure 3.3.2.2 on page 29.

If viewing this documentation online, [click here](#) to see the G Code Quick Reference.

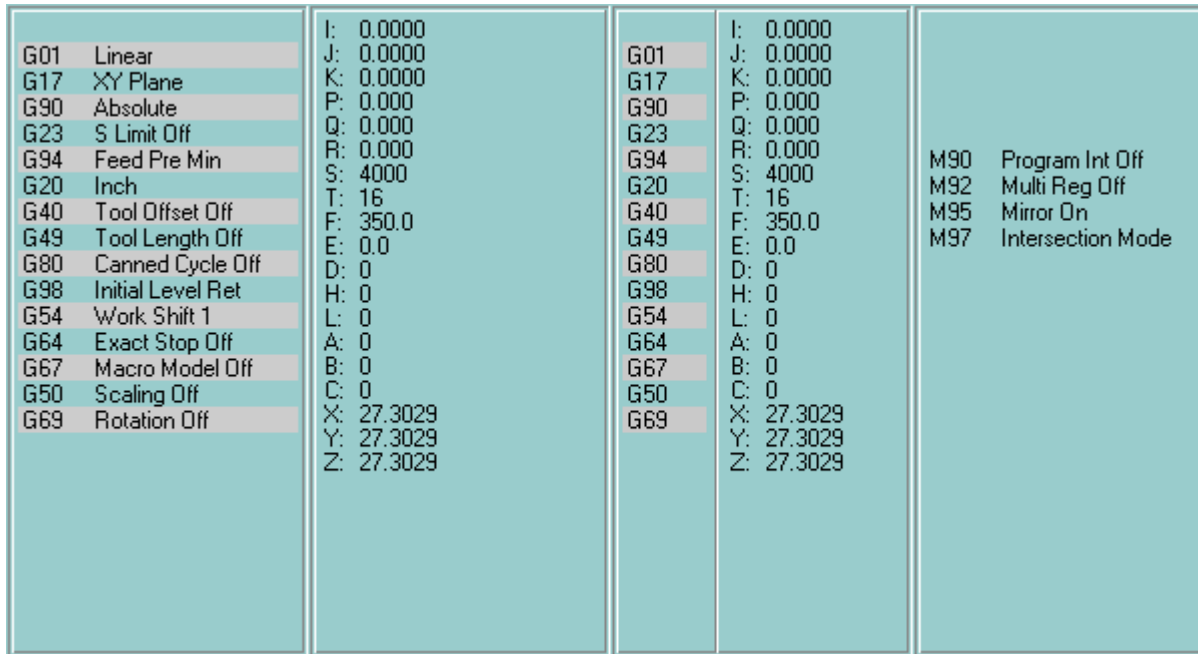

FIGURE 3.3.2.2. 4 Views of the G-code Display Component

Table 3.3.2.1: M Codes

	M code	Comment
1	M90 M91	Program int Off Program int On
2	M92 M93	Multi reg Off Multi reg On
3	M94 M95	Mirror Off Mirror On
4	M96 M97	Round arc mode Intersection mode

Table 3.3.2.2: G Codes

G code group	G code	Comment
01 group	G00 G01 G02 G03	Rapid Linear CW CCW
02 group	G17 G18 G19	XY plane ZX plane YZ plane
03 group	G90 G91	Absolute Incremental
04 group	G22 G23	S limit On S limit Off
05 group	G93 G94	Solid Tap Feed pre min.
06 group	G20 G21	Inch MM.
07 group	G40 G41 G42	Tool offset Off Tool offset left Tool offset right
08 group	G43 G44 G49	Tool length + Tool length - Tool length Off
09 group	G73 G74 G76 G77 G80 G81 G82 G83 G84 G85 G86 G87 G88 G89 G174 G181 G182 G184 G185 G186 G187 G189	Hi-speed deep hole Reverse tapping Boring Back boring Canned cycle Off Drilling Spot facing Deep hole drilling Tapping Boring Boring Boring Boring Boring Rev. deep solid tap 2 step hole drilling 2 step spot facing Deep hole solid tap 2 step boring 2 step boring 2 step boring 2 step boring

G code group	G code	Comment
10 group	G98 G99	Initial level return R point return
12 group	G52 G54 G55 G56 G57 G58 G59	Local coordinate Work shift 1 Work shift 2 Work shift 3 Work shift 4 Work shift 5 Work shift 6
13 group	G61 G64	Exact stop On Exact stop Off
14 group	G66 G67	Macro modal On Macro modal Off
15 group	G50 G51	Scaling Off Scaling On
17 group	G122 G123	Tool life Regist Off Tool life Regist On
18 group	G68 G69	Rotation On Rotation Off
22 group	G128 G129	Cylindrical Off Cylindrical On
23 group	G126 G127	Polar coordinate On Polar coordinate Off

G code group	G code	Comment
Non modal group	G04	Dwell
	G06	Err detect Off
	G09	Exact stop
	G10	Data input
	G12	Circle cut CW
	G13	Circle cut CCW
	G25	Program copy
	G27	Zero ret check
	G28	Zero return
	G29	Ret from zero
	G30	Zero return
	G31	Skip
	G45	Tool offset +
	G46	Tool offset -
	G47	Tool offset 2+
	G48	Tool offset 2-
	G53	Machine coordinate
	G65	Macro call
	G70	Bolt hole circle
	G71	Arc pattern
G72	Line at angle	
G92	Coordinate set	
G106	Auto corner	
G107	Corner feed On	
G108	Corner feed Off	

3.3.3 NC Switch Screen



FIGURE 3.3.3.1. The NC Switch Screen

This is a software version of the CNC pendant panel. See section “Switch Label Screen” on page 93 for more information on creating and enabling or disabling display of these switches. Making changes to this screen requires MTB password or higher. For the **CNC Switches** box, label text and parameter numbers are fixed, and cannot be edited. However, the **Machine Switches** box can be reconfigured. Machine tool builders can reduce the number of machine pendant switches by creating their own software switches on the CNC screen. To make switches, each switch must have a label, output keep relay address and LED output keep relay address. Editing the machine switch table requires MTB password or higher. A maximum of 16 machine switches can be added.

3.3.4 Timers Screen

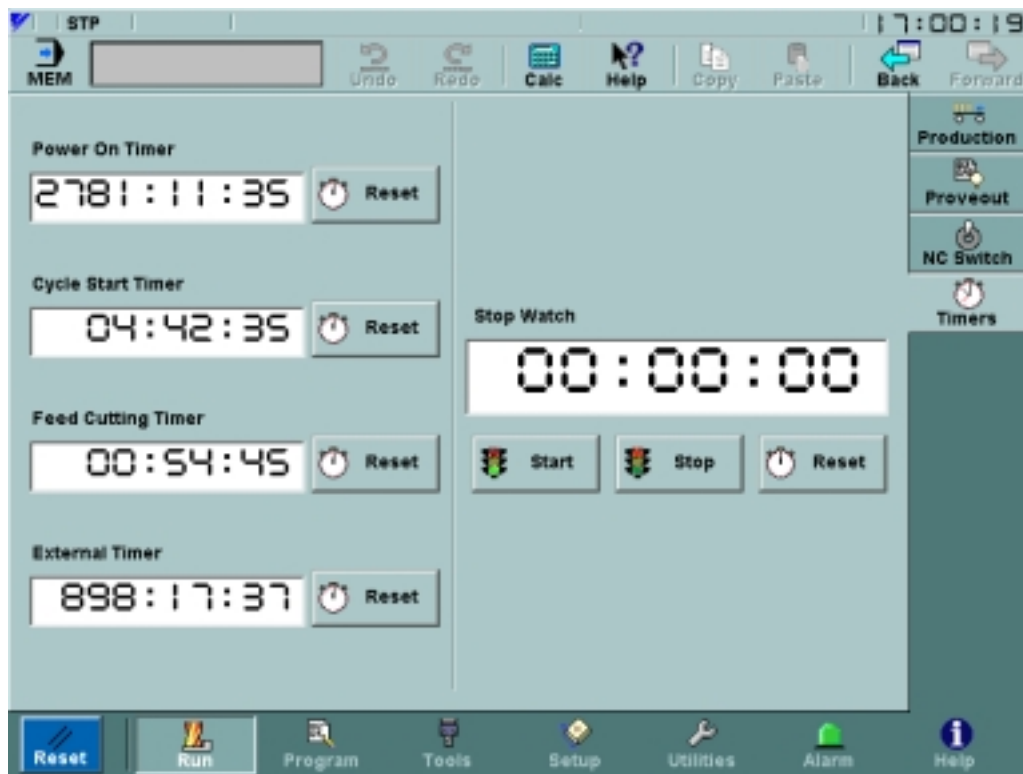

FIGURE 3.3.4.1. The Timers Screen

The *Timers* screen, shown in Figure 3.3.4.1 on page 34, is used to display and reset CNC timers.

The **Power On Timer** displays the total accumulated time after turning the power ON.



The **Cycle Start Timer** displays the total accumulated time in which the NC has operated in the automatic mode.

The **Feed Cutting Timer** displays the total accumulated time in which the NC has operated in the cutting mode.

The **External Timer** displays the total accumulated time in which external input signals have been ON.

Using the Cycle Start Timer:

- Using the *File:Editor* screen, create and save the following program:





```
O00001
G04P10.
M30
```
- Set The NC to memory  mode.
- Set O00001 to be the current program. 

- Switch to the *Run:Timers* screen.
- Touch the **Reset**  button for **Cycle Start Timer** to set it to 00:00:00.
- Press Cycle Start; the timer will start to count up.
- Press Feed Hold; the timer will stop.
- Press Cycle Start again; the timer will continue counting from its previous value.

Using the Feed Cutting Timer:

- Using the *File:Editor* screen, create and save the following program:

```
O00001  
G20  
G90  
G00X100.  
X0.  
G01X1.F10.  
M30
```

- Set The NC to memory  mode.
- Set O00001 to be the current program. 
- Switch to the *Run:Timers* screen.
- Touch the **Reset**  button for **Feed Cutting Timer** to set it to 00:00:00.
- Press Cycle Start. The feed cutting timer does not change until the NC executes the G01 block. At that point, when “F” status is displayed on the screen, the **Feed Cutting Timer** will start to count up.

3.4 PROGRAM MENU

3.4.1 File Screen

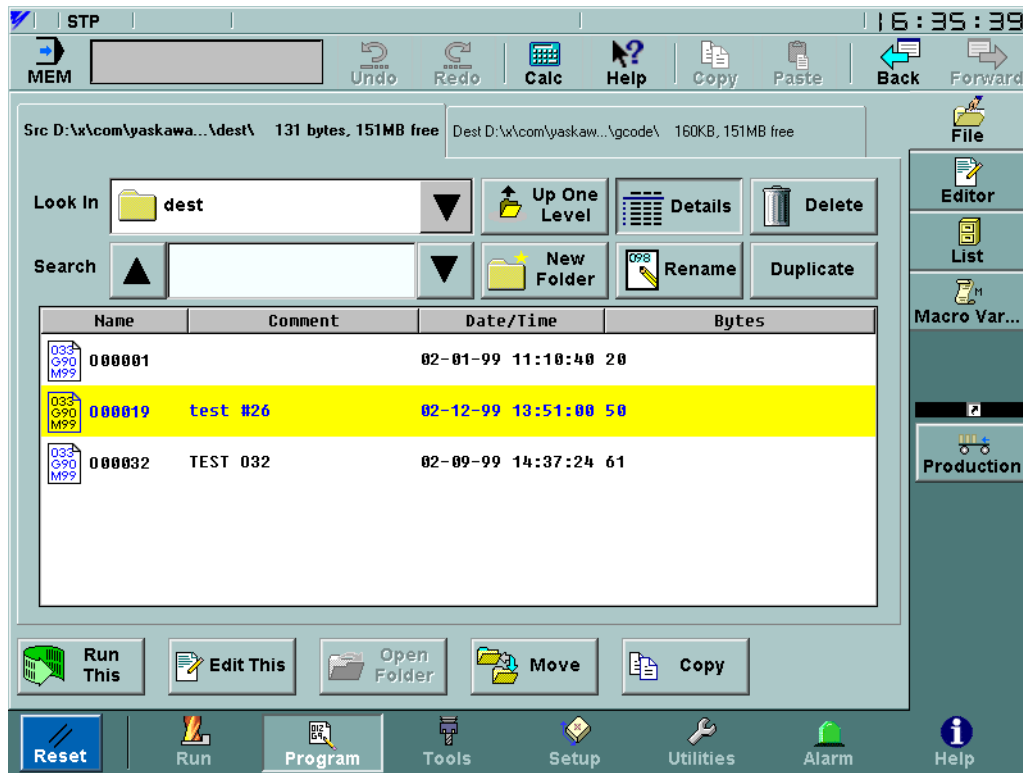



FIGURE 3.4.1.1. The File Screen

The *Program:File* screen is mainly used to specify which programs may be executed or edited. However, it also provides many other file management capabilities. The screen is shown in Figure 3.4.1.1 on page 36. It has two tabs, each of which show a file browser and some buttons.

The file browser is similar to the one discussed in “File Browser” on page 23. The current directory name for the file browser is displayed in the tab at the top. The tab also displays the total disk space used by program files in the selected directory and the amount of space free on the drive. It can be useful when copying to see the size of the file to be copied and the space available at the intended destination.

 The **Details** button can be used to display more data about the programs. When this button is pressed IN, a comment, modification date and file size are shown. Clicking on any of the table headers causes the table to be sorted using the specified field. When the **Details** button is not pressed IN, only filenames are displayed, as shown in Figure 3.4.1.1 on page 36.

Sorting programs using the comment field:

- Using the *Program:Editor* screen, create the following programs with the specified comments:





Program name	Comment
O00010	ABC
O00020	ABD
O00030	ACD
O00040	BCD
O00050	1234

- Switch to the *Program:File* screen and navigate to the directory containing the newly created files.
- If the **Details**  button does not appear to be sunken, touch the **Details** button. The file list will now display details in addition to the file names.
- Touch the **Comment** header button at the top of the file list. The files are now ordered by comment.
- Touch the **Comment** header button again. The order of the files is now reversed.



To delete a program from a directory, first click on it in the list to highlight it, then press the **Delete** button. This button is disabled if no program is selected. A dialog requesting confirmation is shown before any file is deleted. The current executing program *cannot* be deleted.

Deleting a folder that is not empty:

- Touch the folder icon to select the folder to be deleted. The folder’s name should be highlighted in yellow.
- Touch the Open Folder  button. The screen will change to display the files that are in the folder.
- Click the first file in the list. The file’s name should be highlighted in yellow.
- Hold down the Shift key and click the last item in the list. This will cause all items in the list to be selected.
- Touch the Delete  key. A dialog will appear to confirm your selection.
- Press **OK** in the dialog box. At this point the programs should no longer appear in the list.
- Use the Up One Level  button to show the parent directory again.
- Touch the folder icon to reselect the folder to be deleted. The folder’s name should be highlighted in yellow.
- Touch the Delete  button. A dialog window should appear.



- Select **OK** in the dialog window. The window will disappear, and the folder should no longer be shown in the list of files.



The **Search** buttons are used to find a specific file or comment in the file list. The text to seek is entered into the text area, and clicking the up or down arrows causes the search to proceed in a backward or forward direction, respectively.

Hitting the Enter key while the cursor is the search text area will also perform a search in the forward direction. If the details button is pressed in, comments as well as filenames will be searched for the string. Otherwise, only filenames are searched. The file list area will scroll automatically so that the matching file is always shown. Searches are case-sensitive and will wrap to the beginning (or end, depending on search direction). If no match is found, "<string> not found" is displayed in the warning message area.

Searching for a specific program using a comment:

- Using the **New File**  button in the *Program:Editor* screen, create a program with the comment "Run in high speed mode".
- Switch to the *Program:File* screen, and set the directory to be the one in which the new file was stored.
- Press the **Details**  button, so that comments are shown.
- Type "high" in the **Search** text field and press the down arrow until the correct file is highlighted in yellow.



The **New Folder** button pops the *New Folder* dialog, shown in Figure 3.4.1.2 on page 38. This dialog prompts for a name for the new folder, and if **OK** is clicked, the folder is created in the directory specified in the tab. Folder names can have a maximum of 16 characters.

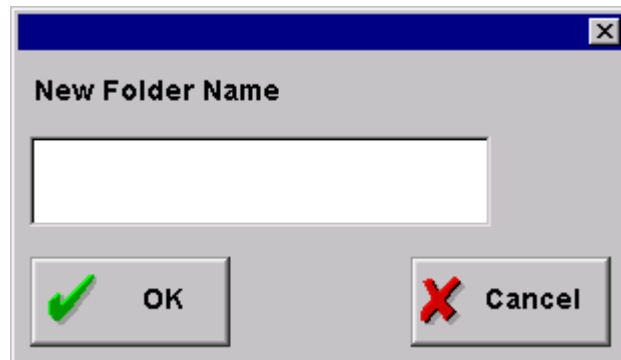

FIGURE 3.4.1.2. New Folder Dialog



The **Rename** button pops the *Rename* dialog, shown in Figure 3.4.1.3 on page 39. It can be used to rename both programs and folders.

The file will be renamed to the text in the **Rename to:** field only if the **OK** button is clicked. It is not possible to rename any open programs (i.e., programs appearing on the *Program:List* screen). An error message will appear if the user attempts to do so.

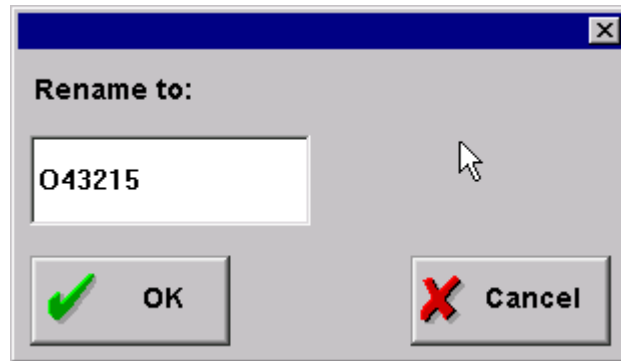

FIGURE 3.4.1.3. Rename Dialog

The **Duplicate** button is used to make a copy of the selected file in the same directory as the selected file. The new file will have “_copy” appended to the original file name. It is not possible to duplicate a file that already has the “_copy” extension.

The buttons along the bottom are active regardless of which tab is chosen. These are:





The **Run This** button is enabled whenever a G-code program is selected in the shown tab, except when the system is not in MEM mode. Clicking on this will set the selected program to be the current program. The *Run:Production* screen will then be shown. Setting an already selected program to be current has no effect. A warning dialog will be shown if this is clicked when the selected file is on a removable or network drive.



The **Edit This** button is used to open a file for editing, and is only enabled if a G-code file is selected in the currently shown tab. A program may only be viewed, not edited, if Edit Lock is ON. Clicking on the button will cause the *Program:Editor* screen to appear, and the selected file will be shown in the editable text area. Only files residing on the hard disk drive may be edited; however, it is possible to view files stored elsewhere. In cases where the file can only be viewed, the button’s caption will change to **View This**. If the selected program is a macro program and Macro Lock is ON, clicking the **Edit This** button will pop a dialog indicating that the program cannot be viewed or edited.

Both **Run This** and **Edit This** will “open” a program. Opening a program implies that it may be executed or edited in the *Program:Editor* screen. All open programs are shown in a list on the “List Screen” on page 49, and the current program is indicated with a green arrow.

 The **Open Folder** button is enabled whenever a directory is selected in the file list. Whenever a directory is opened, its contents are displayed in the file list area, and the directory name is displayed in the tab at the top.

 The **Move** button is used to remove a file from the directory specified in the first (Source) tab, and add it to the directory shown in the second (Destination) tab. The file name does not change.

 The **Copy** button is used to make a copy of the file selected in the first (Source) tab, and place that copy in the directory specified in the second (Destination) tab. This button is disabled if no file is selected in the source directory. A *Confirm File Replace* dialog pops if performing the copy will overwrite an existing program. It is possible to copy multiple programs all at once.

Note: *The Copy, Move and Duplicate functions all check for available disk space. New files are not allowed if less than 1024 bytes are available on the destination drive. Rename, Delete, Move, Copy and Duplicate are disabled if Edit Lock is on.*

There are several parameters that control whether macro programs (programs in the 8000 and 9000 ranges) can be displayed or edited. These parameters are listed in Table 3.4.1.1 on page 40. The effects of combining these parameters are outlined in Table 3.4.1.2 on page 40 and Table 3.4.1.3 on page 41.

Table 3.4.1.1: Macro Lock Parameters

Address	Bit	
pm 20	0	Permits/prohibits display and edit of O8000 - O8999
pm 21	0	Permits/prohibits edit of O8000 - O8999
pm 22	0	Permits/prohibits edit of O9000 - O9999
pm 3004	0	Permits/prohibits display and edit of O9000 - O9999

Table 3.4.1.2: Parameters Controlling O8000 - O8999

pm 21 (edit)	pm 20 (display)	Copy, Rename, Delete, Edit, Duplicate, Move	View
permitted	permitted	yes	yes
permitted	prohibited	no	no
prohibited	permitted	no	yes
prohibited	prohibited	no	no

Table 3.4.1.3: Parameters Controlling O9000 - O9999

pm 22 (edit)	pm 3004 (display)	Copy, Rename, Delete, Edit, Duplicate, Move	View
permitted	permitted	yes	yes
permitted	prohibited	no	no
prohibited	permitted	no	yes
prohibited	prohibited	no	no

Note: An MTB option that controls locking of 9000 range macro programs may affect these parameters.

Creating and deleting a folder:

- Use the **New Folder** button to create an empty folder.
- Touch the folder icon to select the folder. The folder’s name should be highlighted in yellow.
- Touch the **Delete** button. A dialog window should appear.
- Select OK in the dialog window. The window will disappear, and the folder should no longer be shown in the list of files.

Deleting multiple files:

- Touch the file icon to select a file that can be deleted. The file’s name should be highlighted in yellow.
- While holding the Ctrl key, touch two more files. At this point, three files should be highlighted.
- Touch the Delete key. A dialog will appear to confirm your selection.
- Press OK in the dialog box. At this point the programs should no longer appear in the list.

Moving a file to a different directory:

- In the **Source** tab of the *Program:File* screen, navigate to the directory containing the file to be moved, and select the file so that it is highlighted in yellow.
- In the **Destination** tab of the *Program:File* screen, navigate to the directory to which the file should be moved.
- Switch back to show the **Source** tab.
- Click the **Move**  button. The file will no longer be listed in the **Source** tab, but it will appear in the **Destination** tab.

3.4.2 Editor Screen

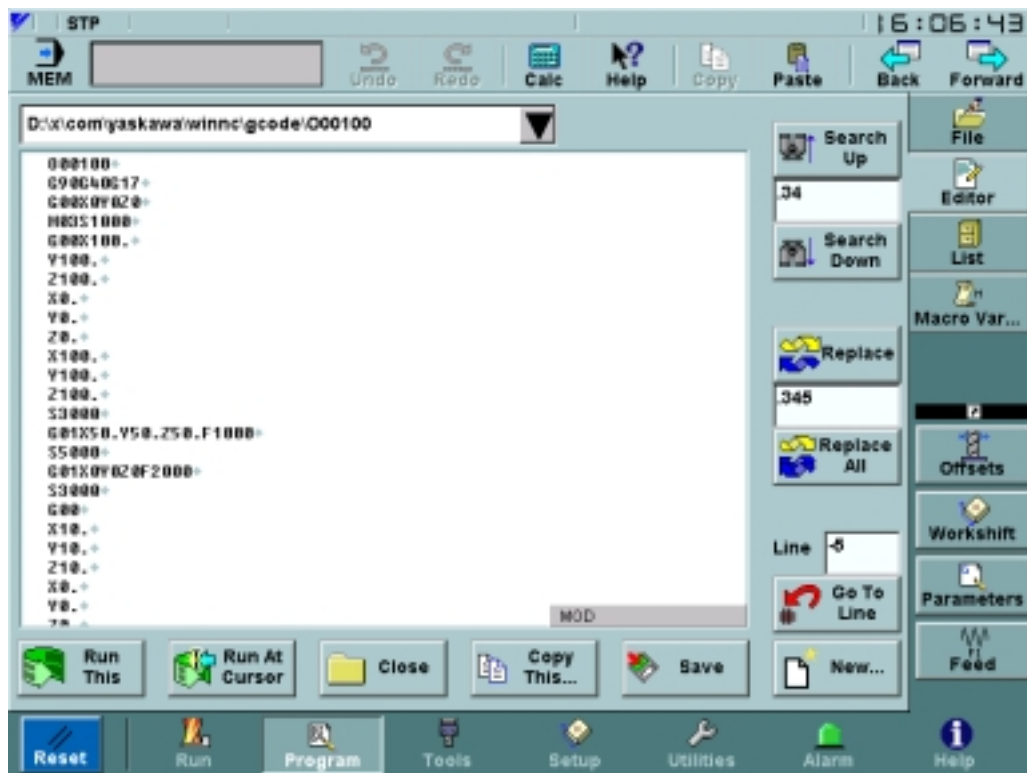



FIGURE 3.4.2.1. The Editor Screen

The *Program:Editor* screen displays the program name, along with 22 lines of editable program text. This text area supports cut, paste, copy, search and replace. If the program shown is currently executing, it can only be edited while stopped in single block mode. Otherwise, the text area becomes non-editable and only searching is permitted. The “Program Running” warning is shown if an attempt is made to edit a running program when it cannot be edited. It is always possible to edit non-executing programs if they are writable. Read-only programs residing on the hard disk are automatically changed to be writable when loaded into the editor. However, read-only programs on network drives or floppy disks will remain read-only when loaded into the editor.

If the *Program:Editor* screen is entered from the *Run:Production* screen, the cursor position is set to the last run point. If switching between buffers on the edit screen, the last cursor edit position is remembered.

The arrow keys on the keyboard can be used to move about within the program. Additionally, some shortcut keys, shown in Table 11 can be used to speed up the editing process.

Table 3.4.2.1: Shortcut Keys

Keys	Result
Ctrl-X	Deletes the selected text.
Ctrl-C	Behavior identical to the Copy  button
Ctrl-V	Behavior identical to the Paste  button.
Ctrl-End	Moves the cursor to the end of the program.
Ctrl-Shift-End	Selects all text from the cursor position to the end of the program.
Ctrl-Home	Moves the cursor to the beginning of the program.
Ctrl-Shift-Home	Selects all text from the cursor position to the beginning of the program.
Page Down	Shows the next page of the program and moves the cursor to the center of the page.
Page Up	Shows the previous page of the program and moves the cursor to the center of the page.
Home	Moves the cursor to the beginning of a line.
End	Moves the cursor to the end of a line.
Shift-[directional arrow]	Selects text from when the Shift key is pressed until the Shift key is released
Shift-Page Down	Selects pages of text from when the Shift key is pressed until the Shift key is released
Shift-Page Up	Selects pages of text from when the Shift key is pressed until the Shift key is released

At the bottom of the text area is a gray status bar, which displays “MOD” if the program has been modified but changes have not yet been saved, and “CUR” if the program displayed is the currently running program.

Selecting the entire program:

- Switch to the *Program:Editor* screen and use the drop-down menu to load a program into the text edit area.
- Type **Ctrl-Home** to position the cursor at the beginning of the program.
- Type **Ctrl-Shift-End** to select all text from the cursor position (at the beginning of the program) to the end of the program.

The drop-down menu in the upper left corner lists all programs that have been opened using the *Program:File* and *Program:Editor* screens. A maximum of 9 programs can be open at a time, and once this limit is exceeded, the oldest is automatically closed when a new one is opened. Programs that are automatically opened (such as executed subprograms) will not appear in this list. When a program is chosen from the menu, the text area will display that program. If another program is being edited when a new one is selected, changes to that program are saved automatically. Modified programs are also saved automatically when leaving the *Program:Editor* screen.



The search field is used to specify a string to be found. Clicking on either the **Search Up** or **Search Down** button will jump to the next occurrence of the string in the file under edit, and the matching area will be highlighted in reverse video. The search is case-insensitive. Searching will commence from a highlighted search match or the cursor position if no match is highlighted. When no more matches are found in the search direction, a "String not found" warning is shown.



The **Replace** and **Replace All** buttons are used in conjunction with the text in the **Search** text field. **Replace** will substitute the string in the replace text field for text matching the string from the search text field. Clicking on **Replace** again will cause the next occurrence of the string to also be replaced. **Replace All** will substitute the string in the replace field for all occurrences of the string in the search field. A confirmation dialog will appear before the **Replace All** occurs. This dialog is shown in Figure 3.4.2.2 on page 44. Once the replace begins, progress bars indicate the status of the search and replace. For lengthy processes, an **Abort** button will permit the **Replace All** to be cancelled. The **Replace All** may be cancelled automatically if the replace would result in a file that exceeds size limits.

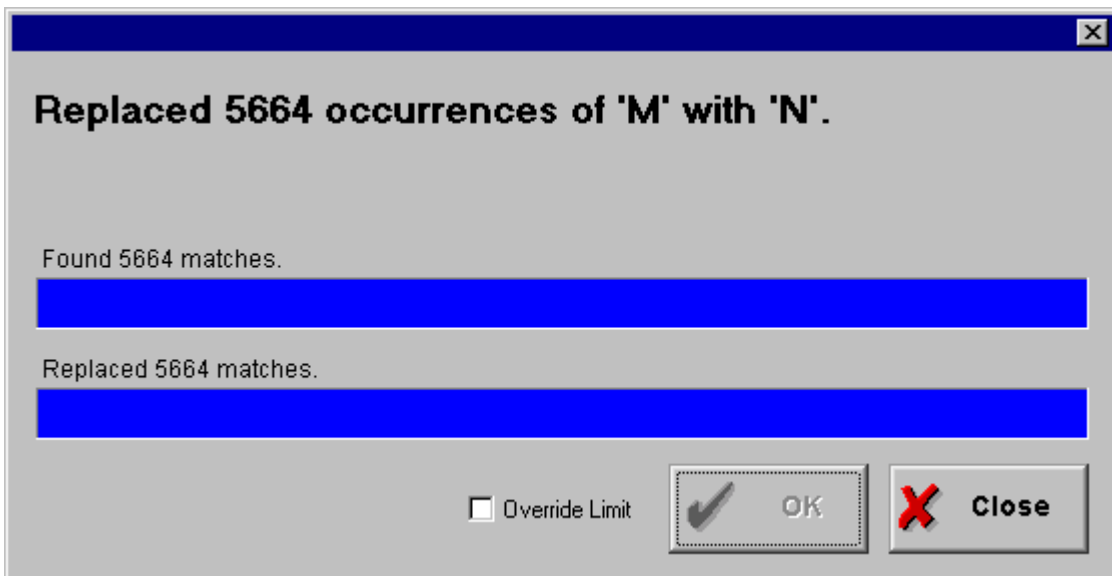
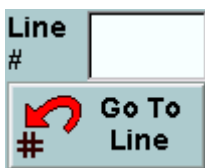



FIGURE 3.4.2.2. The Replace All Confirmation/Status Dialog



The user can move the cursor to a specific line in the G code by entering it in the **Line #** field and clicking the **Go To Line** button. If the line number exceeds the length of the program, the cursor jumps to the end of the program. A plus (+) or minus (-) in front of the number indicates a "relative" Go To. For example, entering "-10" will move the cursor backwards 10 lines. If there are

less than 10 lines, the cursor will move to the first line and highlight it. Similarly, entering "+10" will move the cursor forward 10 lines.

Inserting a word:

- Touch the program text so that the flashing cursor appears *before* the location where the new text is to be added.
- Start typing in the new text. Use the backspace key to make any corrections.
- After the new text is entered, commit the changes by pressing the **Save**  button.



Changing a word:

- Select the text to change, so that it is shown in reverse video.
- Start typing in the new text. After the first keystroke, the old text will disappear.
- After the new text is entered, commit the changes by pressing the **Save**  button.



Erasing a word:

- Text deletion can be accomplished in one of three ways:
- Touch the text editing area to position the blinking cursor at the end of the word to be deleted. Press the **Backspace** key until all the text to be removed is no longer shown.
- Touch the text editing area to position the blinking cursor at the beginning of the word to be deleted. Press the **Delete** key until all the text to be removed is no longer shown.
- Highlight the entire word to erase. Press either the **Backspace** or **Delete** key to remove the word.
- After the text has been removed, commit the changes by pressing the **Save**  button.

Searching for text:

- In the **Search** field, enter the text to be found. Remember that the search feature is case sensitive.
- Press either the **Search Up**  or **Search Down**  button.
- If the text does not appear in the specified direction, "String not found" will be shown in the warning message area. If this occurs, try changing the case of the string or searching for just part of the original search string. Changing the direction of the search may also yield results.

Copying text:

- Touch the screen to highlight the text to copy.
- Click on the **Copy**  button.
- Touch the screen to position the cursor at the location where the text will be pasted.
- Touch the **Paste**  button to paste the copied text at the specified position.

Moving a line of text:

- Highlight the line to be moved.
- Click on the **Copy**  button.

- Hit the **Delete** key once to delete the text, and again to remove the blank line remaining after the text is deleted.
- Touch the screen to position the cursor at the new location for the line.
- Touch the **Paste**  button to place the line at the new position.
- Press the **Return** key to place the moved text on a line of its own.

 The **Run This** button is similar in behavior to the **Run This** button on the *Program:File* screen. Clicking on this will set the program under edit to be the current program, and any unsaved modifications to the program will be saved automatically. The *Run:Production* screen will then be shown. A warning dialog will be shown if this is clicked when the selected file is on a removable or network drive. This button is disabled if the system is not in MEM mode.

 The **Close** button removes the current file from the drop-down menu of files that can be edited. Additionally, the file will no longer appear in the *Program:List* screen.

 **Copy This** is used to make a copy of the contents of the current buffer, if enough disk space is available. This will display the directory selection popup, shown in Figure 3.4.2.3 on page 47. The interface is a standard file browser, discussed in “File Browser” on page 23.

There are several parameters that control whether macro programs (programs in the 8000 and 9000 ranges) can be displayed or edited. These parameters are listed in Table 8. The effects of combining these parameters are outlined in Table 9 and Table 10.

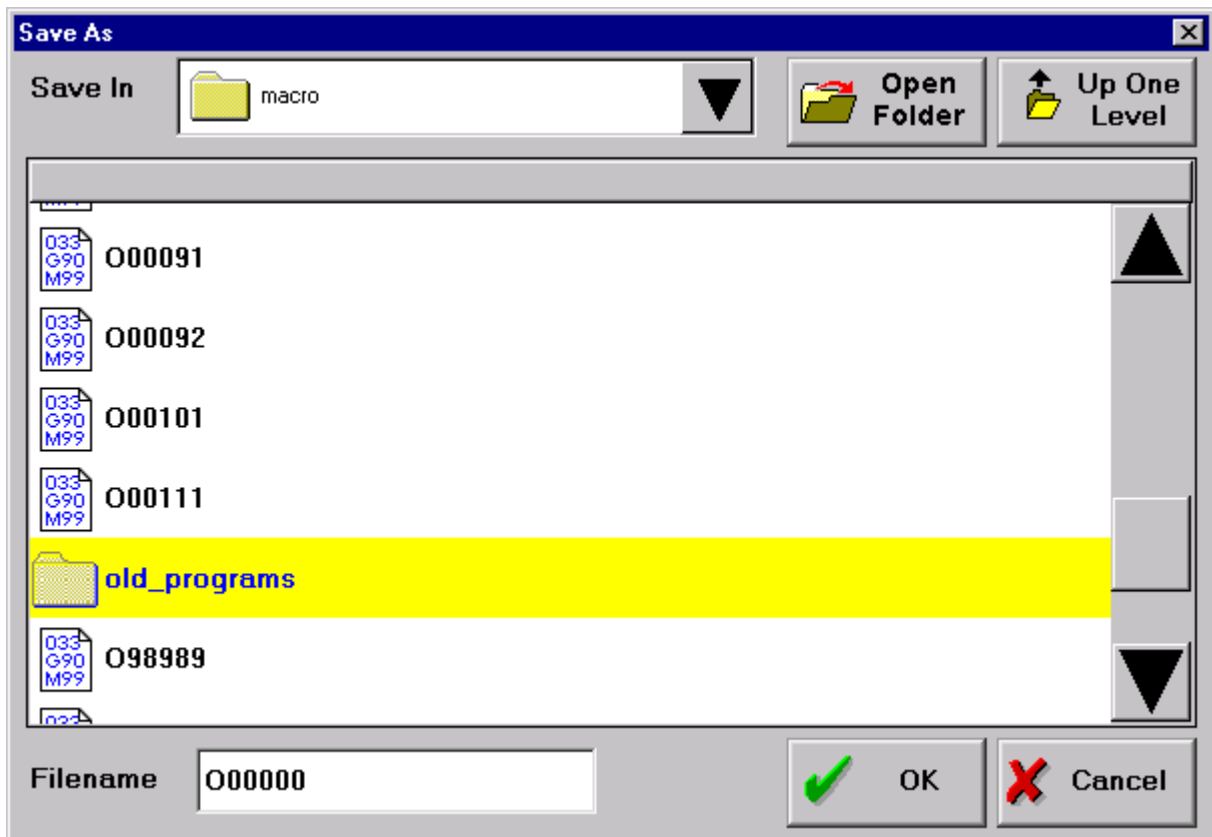

FIGURE 3.4.2.3. Save As Dialog



The **Save** button can be used to save changes to the program. For the most part, this is unnecessary because files are always saved when leaving this screen. If a file is not saved when the system is shut down, a dialog will prompt the user to save the file.



Clicking on **New** will display the *New File* dialog, shown in Figure 3.4.2.4 on page 48. The interface is a standard file browser, discussed in “File Browser” on page 23. Once the dialog is used to specify a name, location and comment for the new program, the text area is cleared and can then be edited. The first line of the program has already been added, and consists of the program name followed by the comment in parenthesis. If there is no text entered in the comment field, no comment or parenthesis will be added to the new file. It is not possible to create a file named O00000. Because of block size limitations, comments are limited to 117 characters or less.

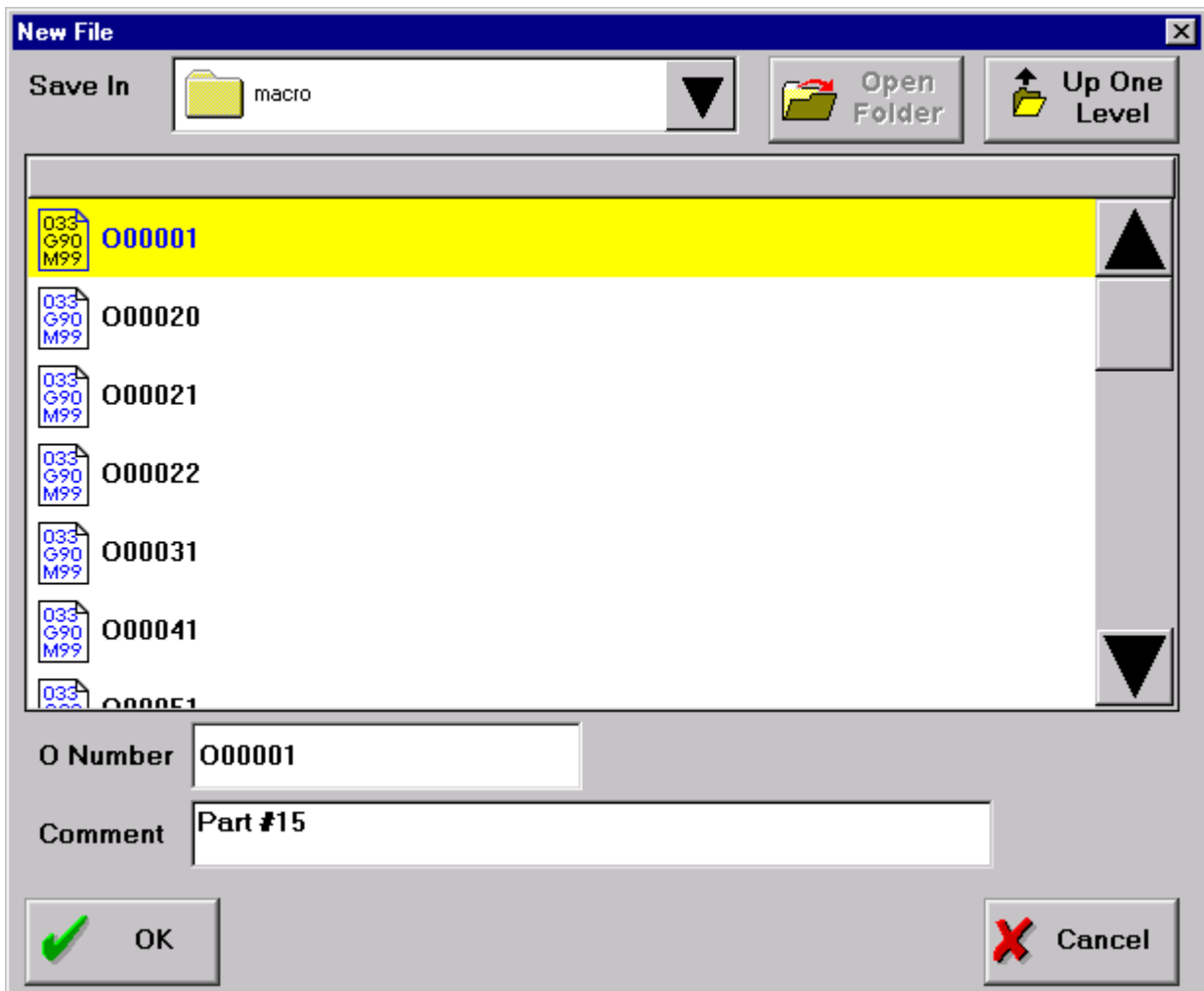





FIGURE 3.4.2.4. New File Dialog

Creating a simple program:



- Switch to the *Program:Editor* screen.
- Click on the **New**  button. The *New File* dialog will appear.
- Navigate to the directory where the code should be saved.
- Type in a program number.
- Touch the **Comment** field to move the cursor, then type in a comment.
- Click the **OK** button. The new program will appear in the editor, and the first line will contain the program name and comment.

Discarding unwanted changes:

- Delete some lines of the program under edit, or type in some random text.
- Click on the **Close**  button.
- A dialog will appear stating that the file has been modified. It will ask whether to discard these changes. Click **OK** discard the changes just made.

- Reopen the file by selecting it in the *Program:File* screen and clicking the **Edit This**  button.
- Note that the changes made in the first step of this example were not saved.

3.4.3 List Screen

The *Program:List* screen, shown in Figure 3.4.3.1 on page 49, displays all the files that can be edited or executed. The current program is indicated with the icon  , while programs that can be edited are indicated by  . A maximum of 9 programs can be open at a time, and once this limit is exceeded, the oldest is automatically closed when a new one is opened. Programs that are automatically opened (such as executed subprograms) will not appear in this list.

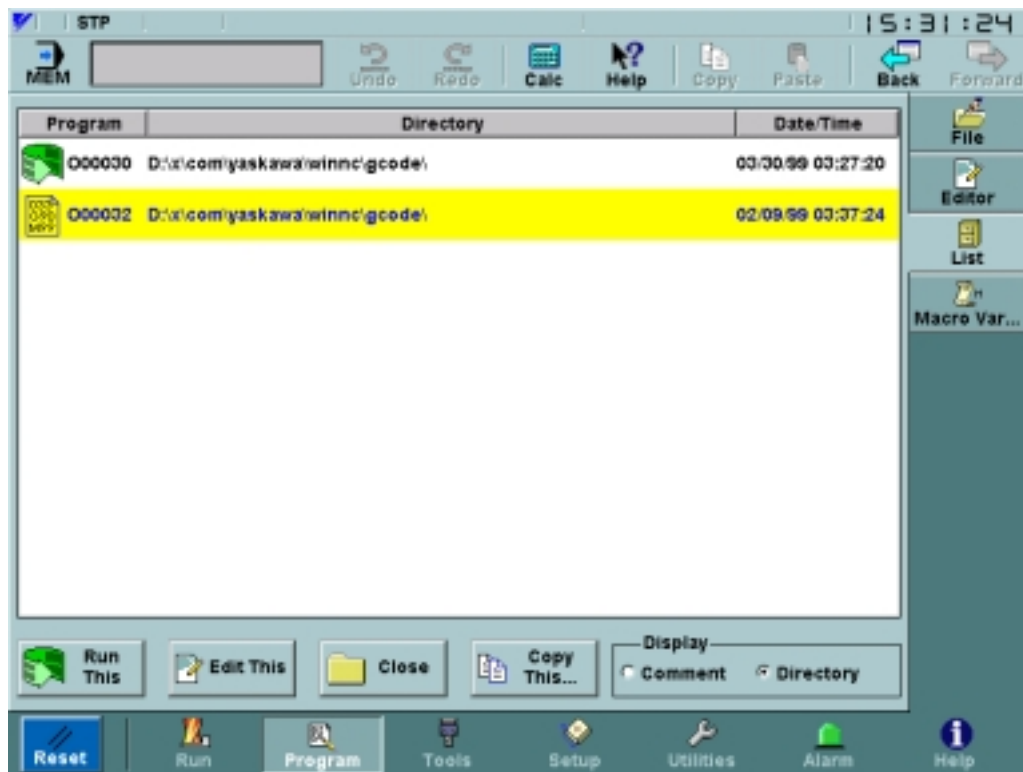





FIGURE 3.4.3.1. The List Screen

 The current program may be set by clicking the **Run This** button while an item in the list is highlighted. This will also cause the *Run:Production* screen to be displayed. A warning dialog will be shown if this is clicked when the selected file is on a removable or network drive. This button is disabled if the system is not in MEM mode.

 A program in the list can be edited by clicking **Edit This**. A program may only be viewed if Edit Lock is ON.

 If a program is no longer being used, the **Close** button will remove it from both the *Program:List* screen and the drop-down menu in the *Program:Editor* screen.

 The **Copy This...** button makes a copy of the selected program and stores it in the specified directory using the specified file name.



Using the **Display** toggle, the *Program:List* screen can be configured to show either the **Directory** where a program is stored, as in Figure 3.4.3.1 on page 49, or the **Comment** associated with the program, as in Figure 3.4.3.2 on page 50.

There are several parameters that control whether macro programs (programs in the 8000 and 9000 ranges) can be displayed or edited. These parameters are listed in Table 3.4.1.1 on page 40. The effects of combining these parameters are outlined in Table 3.4.1.2 on page 40 and Table 10 on page 38.

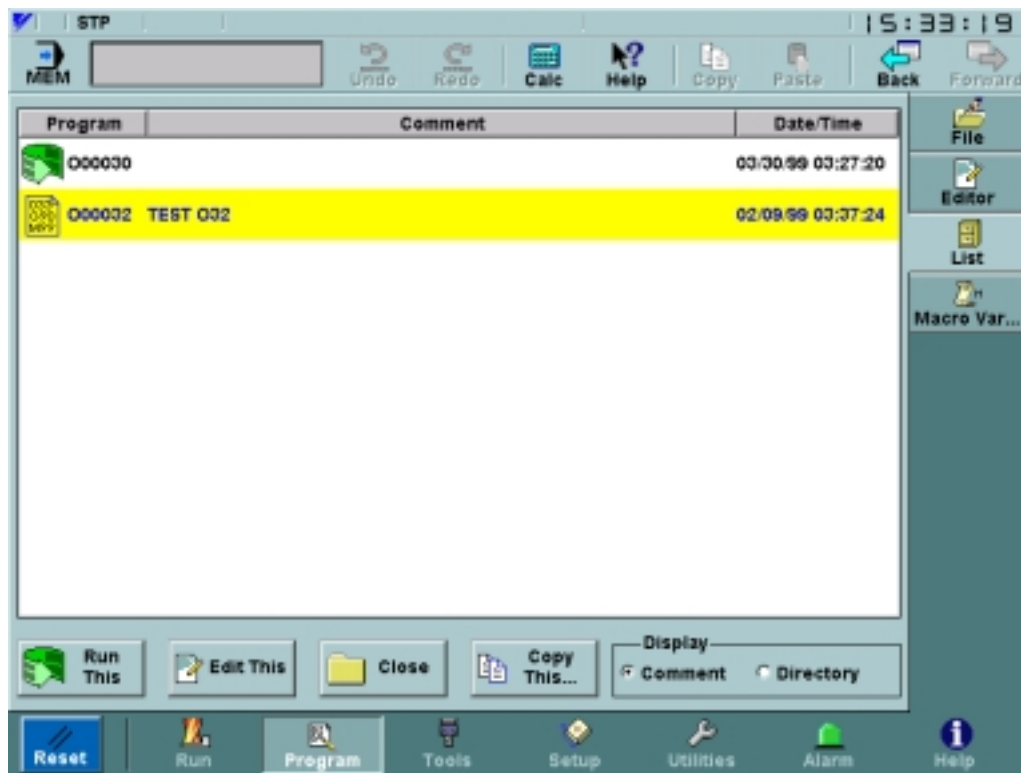

FIGURE 3.4.3.2. List Screen showing comments

3.4.4 Macro Variables

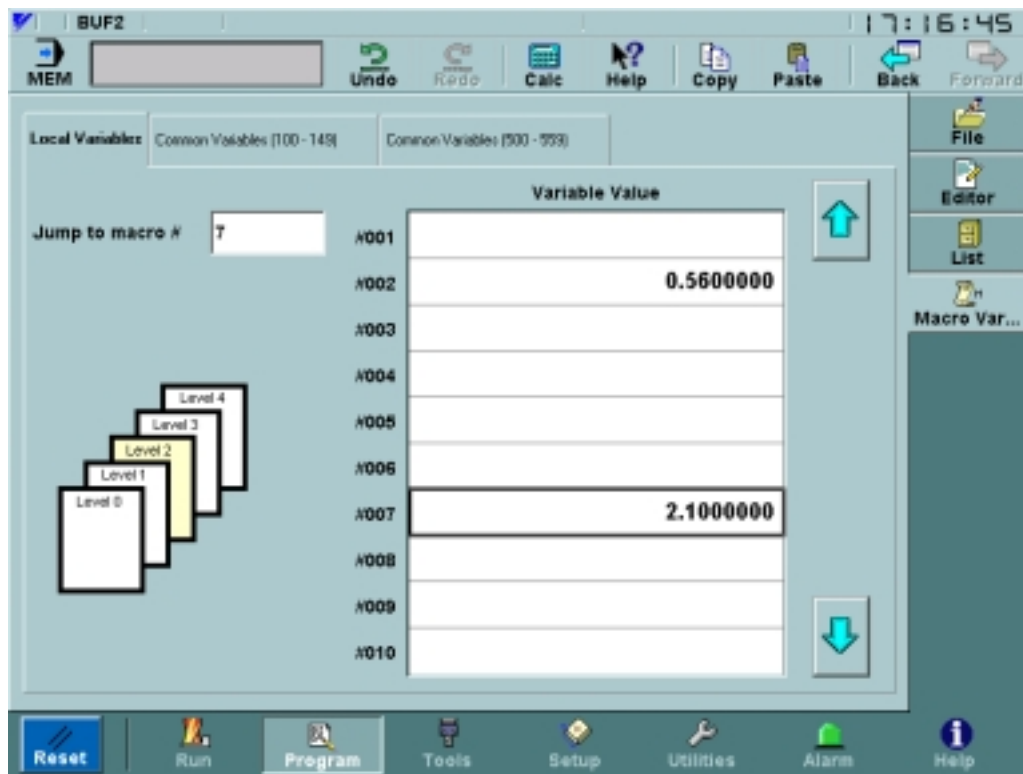

FIGURE 3.4.4.1. Local Variables Tab of Program:Macro Variables

The *Program:Macro Variables* screen is used to view and edit both local and common macro variables. Local macro variables can be set from macro programs, and are shown in Figure 3.4.4.1 on page 51. The graphic on the left side of the screen indicates the level for the currently displayed local variables. This screen updates continuously when macro programs are executed. Common macro variables are set using the common macro variable tabs, one of which is shown in Figure 3.4.4.2 on page 52. Common macro variables will keep their values when the machine is shut off; local macro variables will not.

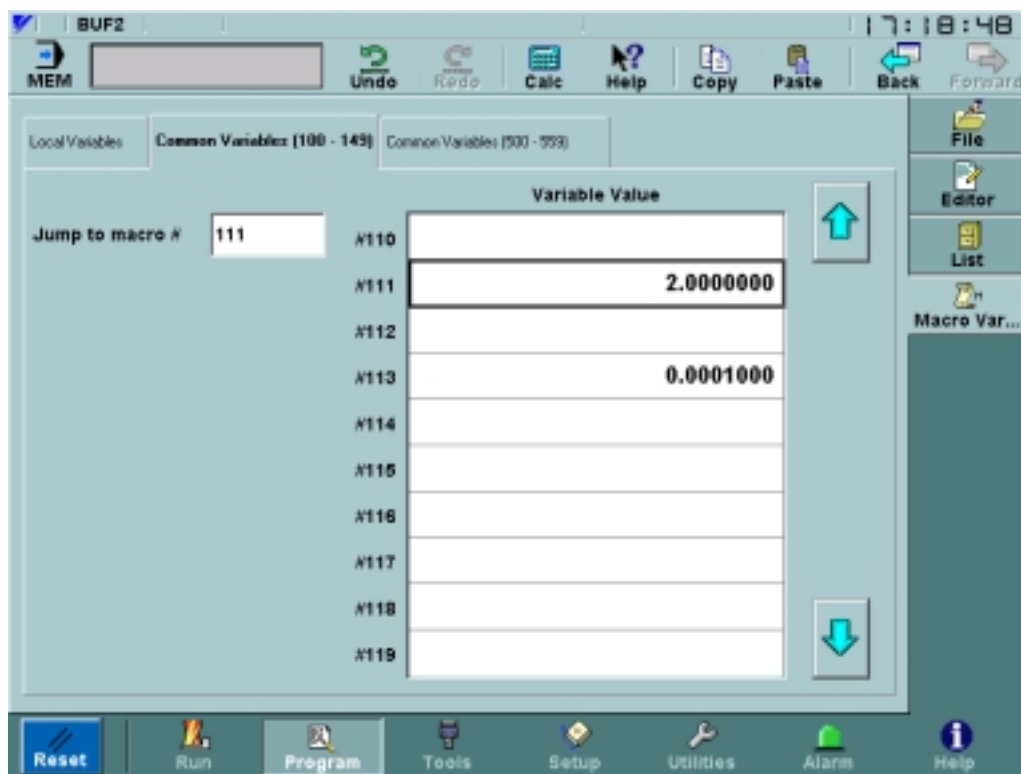

FIGURE 3.4.4.2. Common Variables Tab of Program: Macro Variables

3.5 TOOL MENU

3.5.1 Offsets Screen

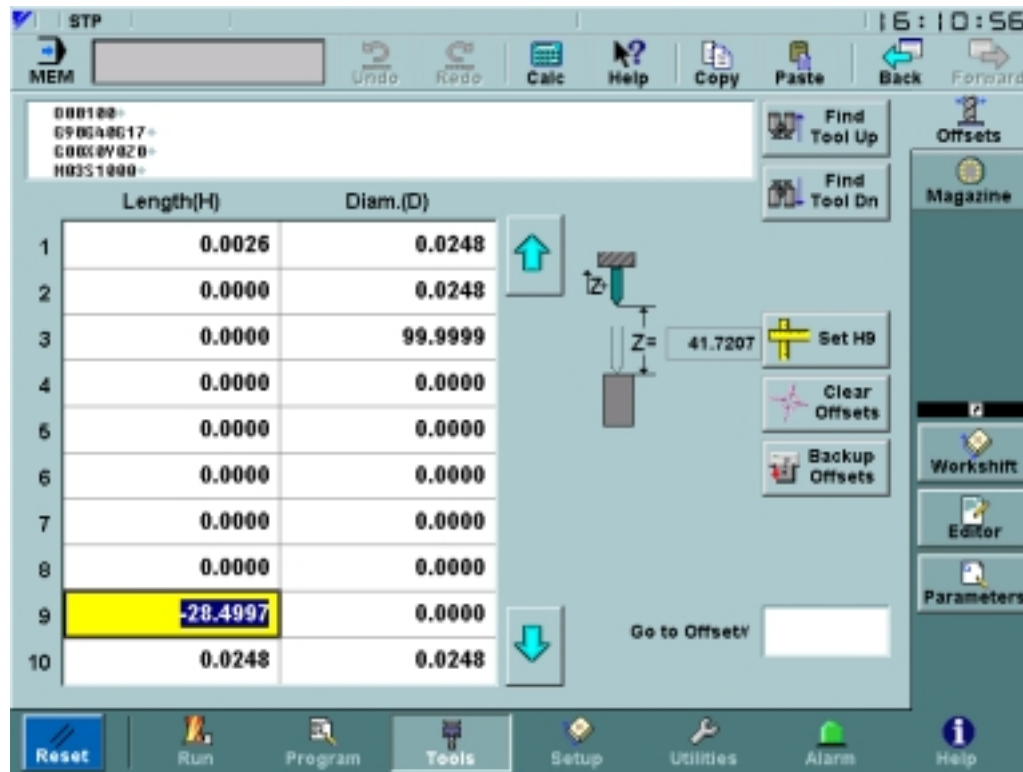



FIGURE 3.5.1.1. The Tool Offsets Screen

The *Tools:Offsets* screen provides a link between tool offsets and the current program. The program name is displayed, along with 3 lines of non-editable, scrollable program text. This display gives the ability to quickly search for lines in the G-code program that refer to the currently selected tool. Unlike in the *Run:Proveout* screen, searching in this program display does not set the running pointer position.

 When either **Find Tool** buttons is clicked, the current program searches for the tool that is selected in the tool offsets table. If a matching tool exists, the "T" is highlighted in reverse video. Otherwise, "No Tool Command Found" is shown in the warning message area.

Below the program display is an editable table that shows tool geometry, and optionally, and tool wear compensation values. When data is entered, it is checked to ensure it falls within a certain range. The range for metric input is from -999.999 to 999.999. For English units, the range is from -99.9999 to 99.9999. Data falling outside these limits will result in the appearance of an "Out of Range" message in the warning message area.

This table can be navigated using the up and down arrow buttons  or the arrow, Tab and page up/down keys on the keyboard. Depending on parameter values, the offsets table may not appear.

If that situation occurs, a dialog similar to the one shown in Figure 3.5.1.2 on page 54 will indicate the actions necessary to display the tool offsets.

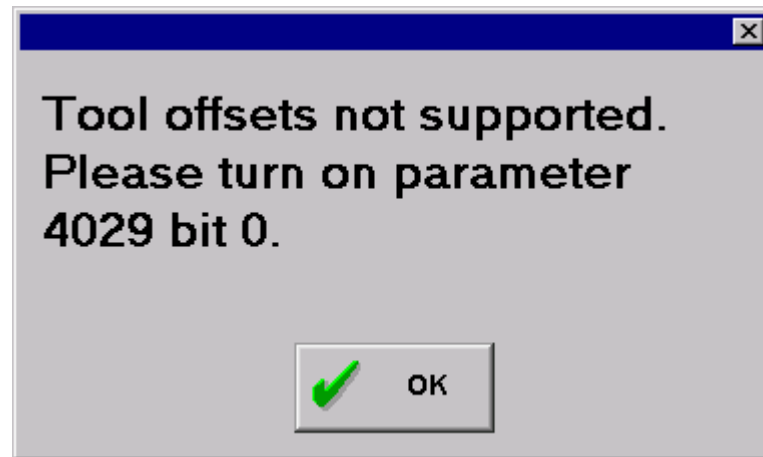



FIGURE 3.5.1.2. Tool Offsets Error Message

 The **Set** button is disabled unless a tool length offset (H) value is selected in the table. The text on the button changes to reflect which cell in the table is chosen. When this button is clicked, the current Z for the machine is used to calculate the tool stickout, and this new data is entered into the table. The stickout value is indicated by the Z shown in the drawing.

Using the machine position to set the tool offset:

- Touch H05 length offset (5th row in the **Length(H)** column) to select it. The **Set**

 button will change to **Set H5** and the grid cell will be outlined in black.

- Set the NC to manual mode.
- Move the Z axis to a new position. The drawing to the left of the **Set** button will reflect this change in Z.
- Press the **Set H5** button. The machine's Z position is copied into the H05 offset in the grid.

 The **Clear Offsets** button will set all values in the tool offset table to zero. Wear values, if they exist, will also be set to zero. Before the offsets are cleared, a confirmation dialog will pop with the prompt "DO YOU REALLY WANT TO SET ALL TOOL OFFSETS TO ZERO?".

 The **Backup Offsets** button allows the current tool offsets to be saved. Clicking on this causes the *Backup and Restore* screen to be shown. For more information, see "Backup and Restore Screen" on page 68. To return to the *Tools:Offsets* screen, click the **Back** but-

ton 

Traversing the tool offsets table:

- Touch the one of the cells in the tool offset table. This will cause the cell to be outlined in black.
- Try pressing some of the arrow keys on the keyboard to move around in the table. The black outline will jump to the next selected cell. If that cell is in the **Length** column, the text on the **Set** button will also change to reflect which offset is selected.
- The **PgDn** key is used to move to the next page of offsets. The **PgUp** key will go to the previous page. The up and down arrows to the right of the grid can also be used to change pages.

3.5.2 Magazine Screen

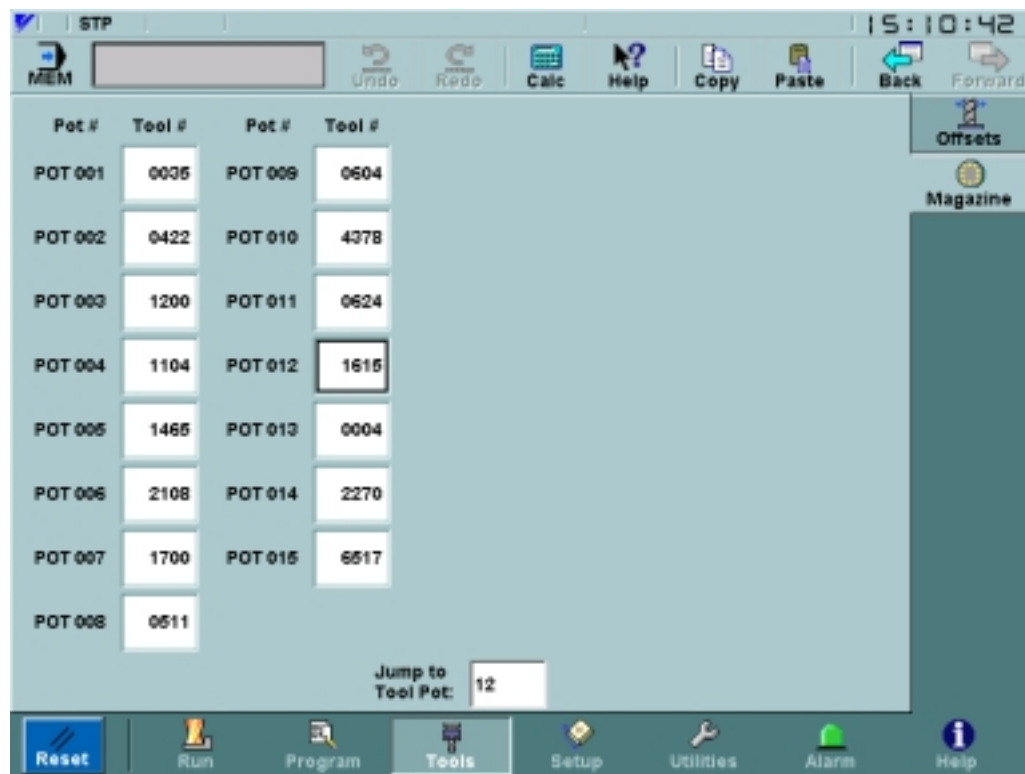

FIGURE 3.5.2.1. The Tool Magazine Screen

The *Tools:Magazine* screen, shown in Figure 3.5.2.1 on page 55, displays the current associations between tool pots and tool numbers. Tool numbers can be either 2 or 4 digits, based on parameter settings. Tool pot data is stored in keep memory, and these keep memory addresses are also set using parameters.



If the tool pots table is too large to fit on one screen, the arrow up and down keys will appear and can be used to scroll to previous and subsequent pages of tool pot data.

It is possible to search for a particular tool pot on the screen. To do this, type a number into the **Jump to Tool Pot** field and press **Enter**. The tool value corresponding to the matching tool pot will be highlighted.

The tool number fields in this screen are editable. When tool numbers are displayed using 2 digits, then allowable data is in the range 0 to 99. For tool numbers displayed using 4 digits, allowable data is in the range 0 to 9999. Once a number is typed into a field, **Enter** must be pressed to commit the changes.

3.6 SETUP MENU

3.6.1 Workshift Screen

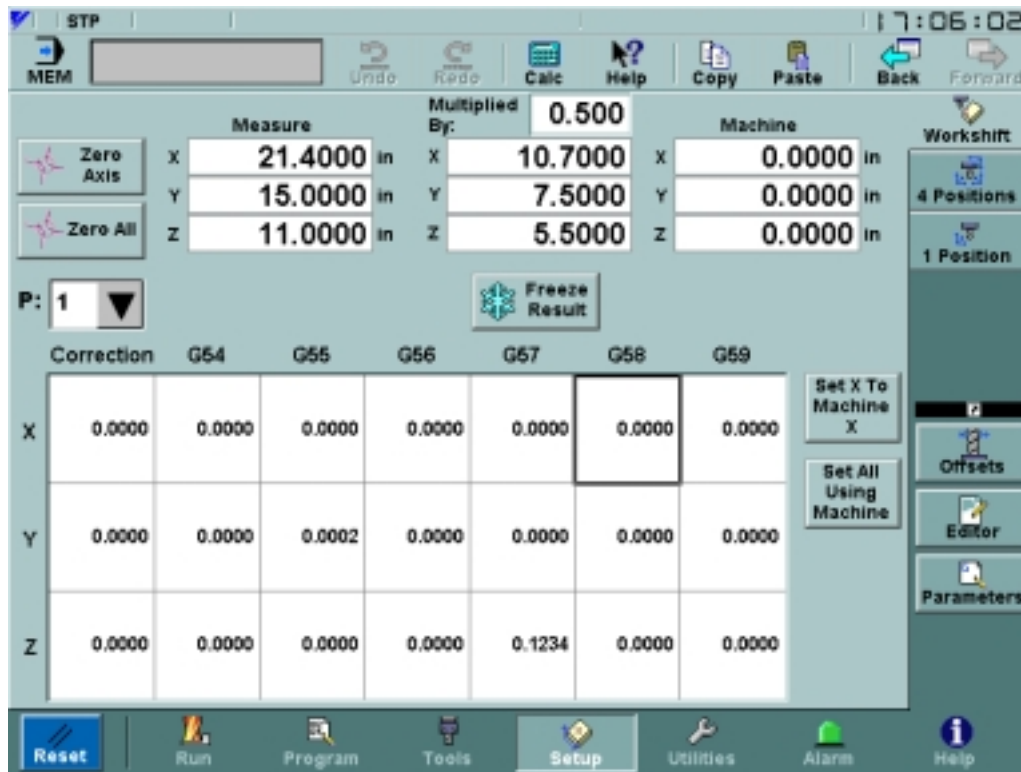



FIGURE 3.6.1.1. The Setup Workshift Screen

The *Setup:Workshift* screen is dual-purpose. Components in the upper half of the screen can be used to find the center of a part or determine an origin for a coordinate system. In addition, the components in the lower half of the screen can be used to view and edit workpiece coordinate systems.

At the top of the *Setup:Workshift* screen, Measure and Machine positions are displayed. For more information on these components, see “Position Display” on page 19. The Machine position is not directly editable, but it is possible to edit the Measure position and any or all of its axes may be set to zero.

- 

The **Zero Axis** button is used to set an individual axis in the Measure position to zero. To do this, click on an axis in the position display to select it. Next, click on the **Zero Axis** button to set the value to zero.
- 

The **Zero All** button is similar to the **Zero Axis** button, but it sets all axes to zero and does not require an individual axis to be selected.

Multiplied By:	1.0
X	0.0000
Y	0.0000
Z	0.0000

Between the Measure and Machine position displays is a calculated coordinate display. Above the axis values is a **Multiplied By** field that specifies whether the calculated coordinates are double, half, or some other proportional value of the Measure frame.



The **Freeze Result** button is used to stop the value of the calculated coordinates from changing. If the result is not frozen, the display will change whenever the Measure value changes.

At the bottom of the screen is a table displaying workpiece coordinate systems and a correction value. The **P** choice widget above the table is used to specify which P value is in effect for G54 to G59. There can be 6, 54, or 162 sets of workshift coordinates, corresponding to maximum P values of 1, 9 and 27 respectively.

Note: Depending on the value of parameter 4012, bit 7, "J" may be displayed instead of "P".

The cells in the table are selectable and their values can be edited in place, unless edit lock is on. The cells can also be set to one of the axis values of the current machine position. This is done with the **Set X to Machine X (Set Y to Machine Y, etc.)** button to the right of the table. The label on this button changes depending upon which axis, if any, is selected in the table. **Set All Using Machine** changes the selected workpiece coordinate system to be the current machine position.

Finding the center of a part:

- First move the tool to one side of the part.
- Zero the desired coordinate (or all coordinates) of the Measure frame using the **Zero Axis** or **Zero All** button.
- Move the machine to the other side of the part.
- Set the **Multiplied By** field to .5. At this point the calculated coordinates are half the value of the Measure coordinates.
- Click on the **Freeze Result** button so that the calculated coordinates remain constant.
- Using the handwheel, move the machine until the Measure position display and the calculated coordinate display are the same for the desired coordinate. The machine is now at the center of the part for the desired axis.
- Once this is done, the X, Y, or Z can be set for a frame in the table at the bottom of the screen by using the buttons to the right of the table. These buttons will replace the specified coordinates for the highlighted frame with the machine position.

3.6.2 Four (4) Positions Screen

This screen shows position displays for the four major coordinate systems. For more information on position displays, see "Position Display" on page 19. Workpiece and Measure are editable; Distance to Go and Machine are for display purposes only. The Measure coordinates may be

edited at any time. The Workpiece frame may only be edited in manual modes (Rapid, Jog, Handle and Step) when the machine is not running.

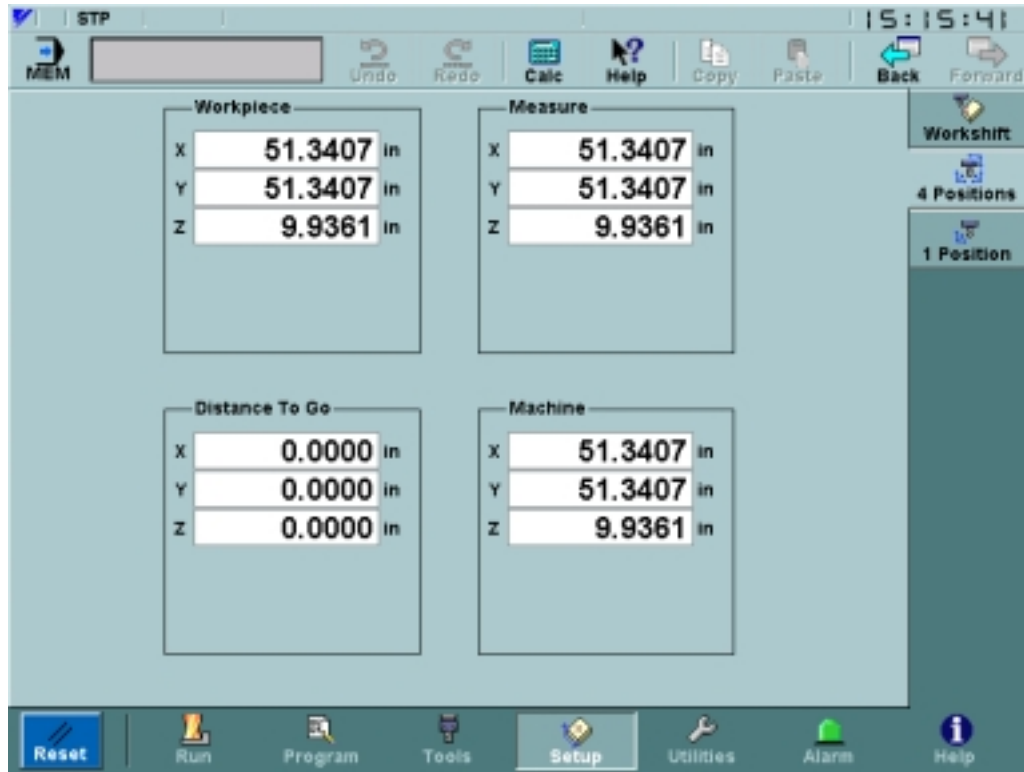

FIGURE 3.6.2.1. The 4 Positions Screen

3.6.3 One (1) Position Screen

This screen shows one large, non-editable position display. For more information on position displays, see “Position Display” on page 19.

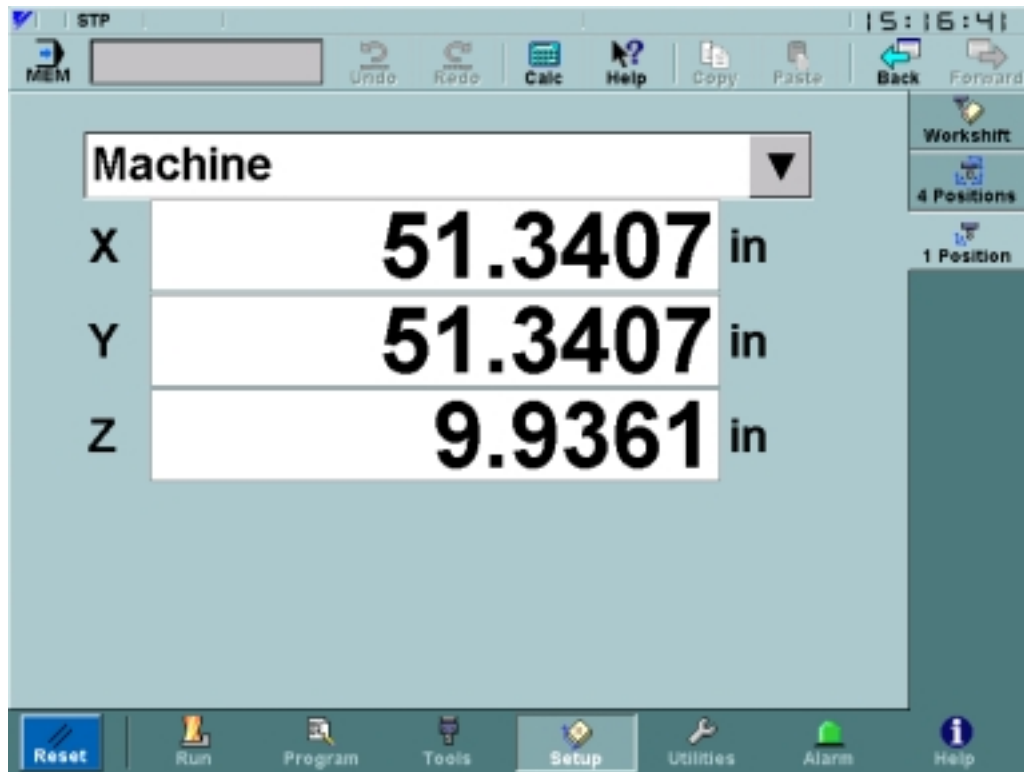

FIGURE 3.6.3.1. The 1 Position Screen

3.7 UTILITIES MENU

3.7.1 Login Screen

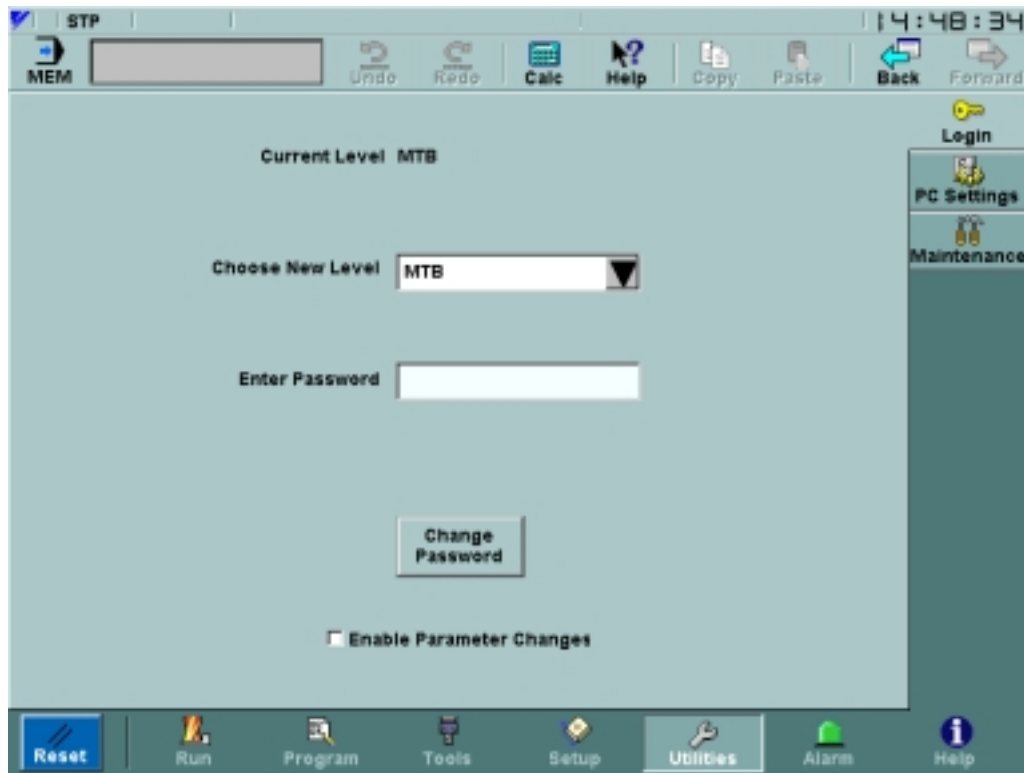

FIGURE 3.7.1.1. The Login Screen

The *Utilities:Login* screen, shown in Figure 3.7.1.1 on page 61, can be used to change the user level, enable and disable parameter writing, and define new user level passwords. Changing passwords is restricted to Machinist level or higher, and it is not possible to change the password for Service level or any level higher than the current one. The *Change Password* dialog is shown in Figure 3.7.1.2 on page 62.

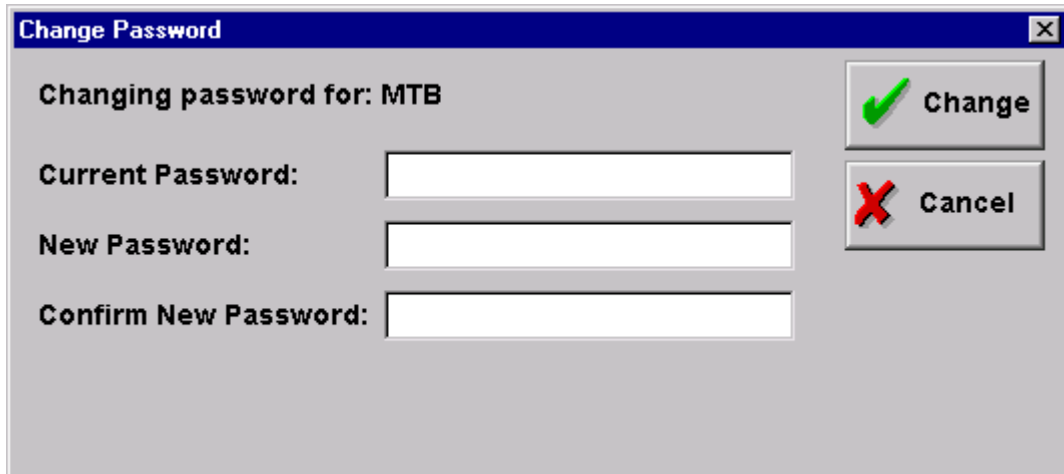

FIGURE 3.7.1.2. The Change Password Dialog

Procedure to reset the Machinist password:

- Go to the *Utilities:Login* screen and log in as Manager.
- Change the user level down to Machinist.
- Press the **Change Password** button.
- Enter the Manager password in the *Current Password* dialog.
- Enter the new Machinist password twice.
- Press the **Change** button.

Enabling parameter writing:

- Go to the *Utilities:Login* screen and make sure that the **Enable Parameter Changes** switch is not checked. This will prevent any parameter above pm1000 from being changed.
- Log in as Machinist.
- Change to the *Utilities:Maintenance:Parameter Search* screen.
- Turn off the **Search** switch so that drop-down menus are displayed at the top of the screen.
- Set the first drop-down menu to “Tooling.” The parameter “Simplified TLM” should be disabled.
- Go to the *Utilities:Login* screen.
- Press the parameter writing enable check box.
- Go back to the *Utilites:Maintenance:Parameter Search* screen. “Simplified TLM” should be enabled, and can now be edited.

3.7.2 PC Settings Screen

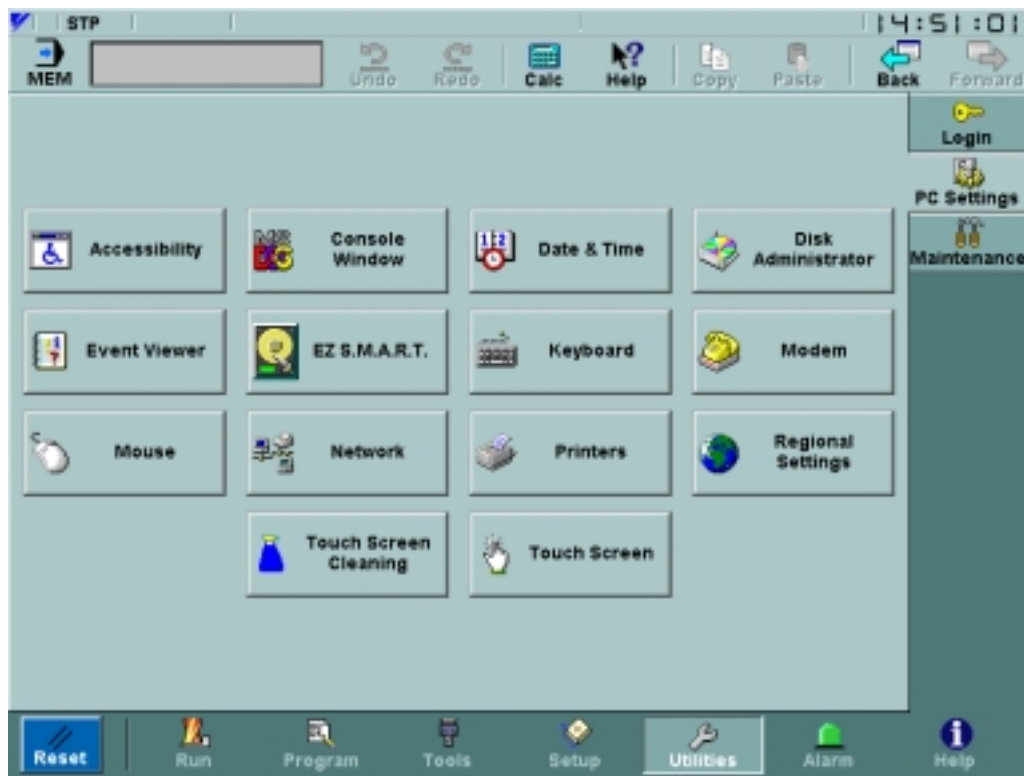

FIGURE 3.7.2.1. The PC Settings Screen

The *Utilities:PC Settings* screen, shown in Figure 3.7.2.1 on page 63, provides easy access to common system tasks such as setting keyboard and mouse configurations or calibrating the touch screen. Many of these functions are not available at certain user levels; the required access level for each is shown in Table 3.7.2.1 on page 63.

Table 3.7.2.1: User Levels Required for PC Settings Functions















Icon	Name	Function	Minimum Required User Level
	Accessibility	Used to customize software to work more easily for people with physical limitations.	Machinist
	Console Window	Opens a DOS window where commands may be entered.	MTB
	Date & Time	Allows the computer's date, time and time zone settings.	Operator
	Disk Administrator	The Disk Administrator can be used to manage the hard disk, such as partitioning new disks or further partitioning disks.	MTB

Table 3.7.2.1: User Levels Required for PC Settings Functions

Icon	Name	Function	Minimum Required User Level
	Event Viewer	Event Viewer is a tool to troubleshoot various hardware and software problems or monitor server security events.	Machinist
	EZ S.M.A.R.T.	Self-monitoring analysis and reporting technology. Can be used to predict hard drive problems.	Operator
	Keyboard	Used to change such keyboard settings as repeat rate and keyboard type.	Machinist
	Modem	Can be used to configure and install modems.	Manager
	Mouse	Used to set mouse parameters such as double click speed and cursor icons.	Machinist
	Network	This is used to view and configure network protocols, services, and adapters.	Manager
	Printers	A shortcut to the printer setup program, where accessible printers and their properties can be viewed or edited.	Machinist
	Regional Settings	Changes regionally dependent items such as currency, date and time display.	Machinist
	Touch Screen Cleaning	Used to switch to a screen that does not respond to touch, so that the screen may be cleaned.	Operator
	Touch Screen	Calibration for the touch screen.	Operator

3.7.3 Maintenance Screen

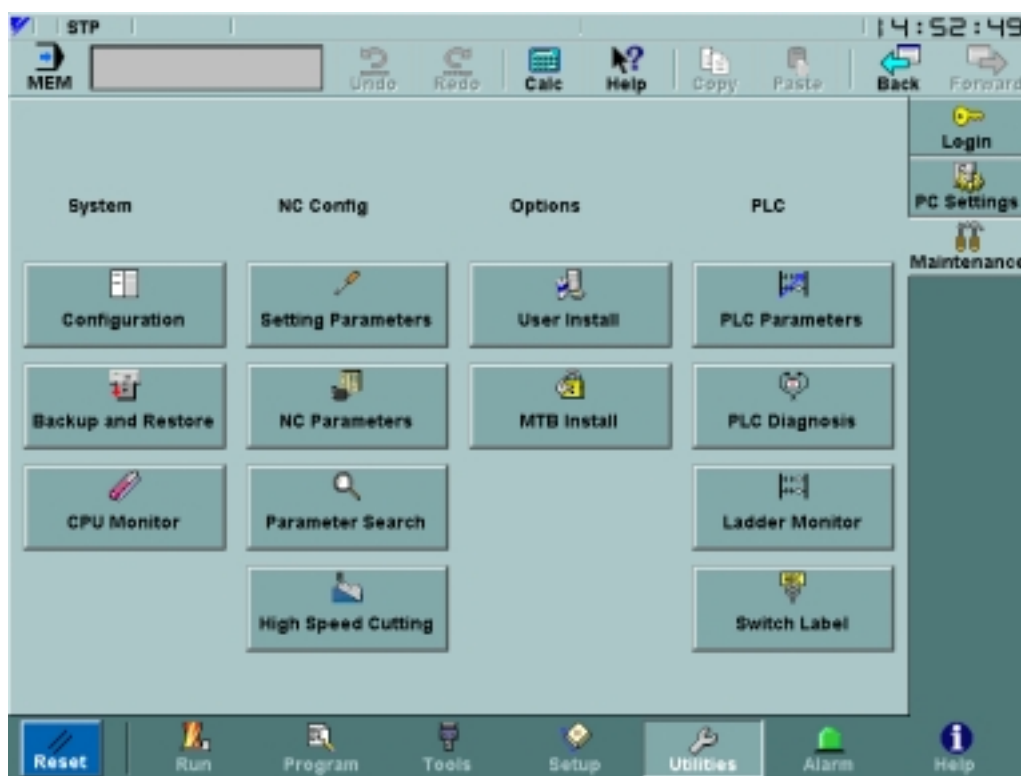

FIGURE 3.7.3.1. The Maintenance Screen

3.7.4 Configuration Screen

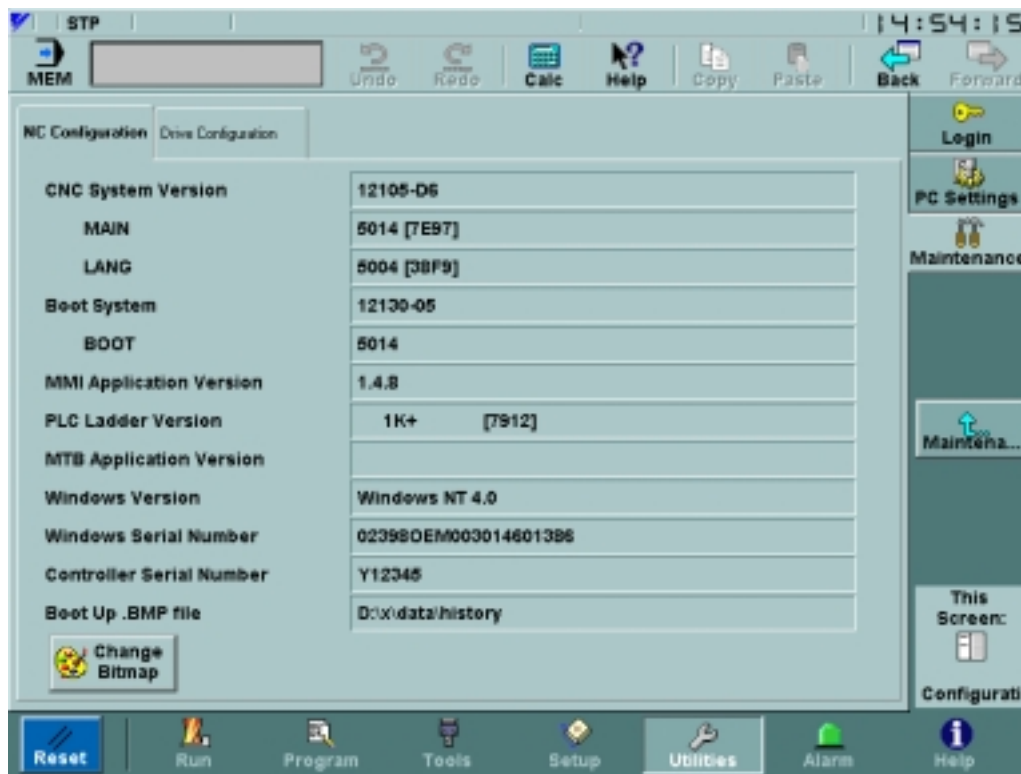



FIGURE 3.7.4.1. Configuration Screen - NC Configuration

The **NC Configuration** tab of the *Configuration* screen, shown in Figure 3.7.4.1 on page 66, is provided for maintenance purposes and is not used for daily operation. This screen displays such non-editable information as system numbers and software versions. The **Boot Up .BMP** file is editable, and can be set by clicking the Change Bitmap  button. This button is only enabled for users with access levels of MTB or higher.

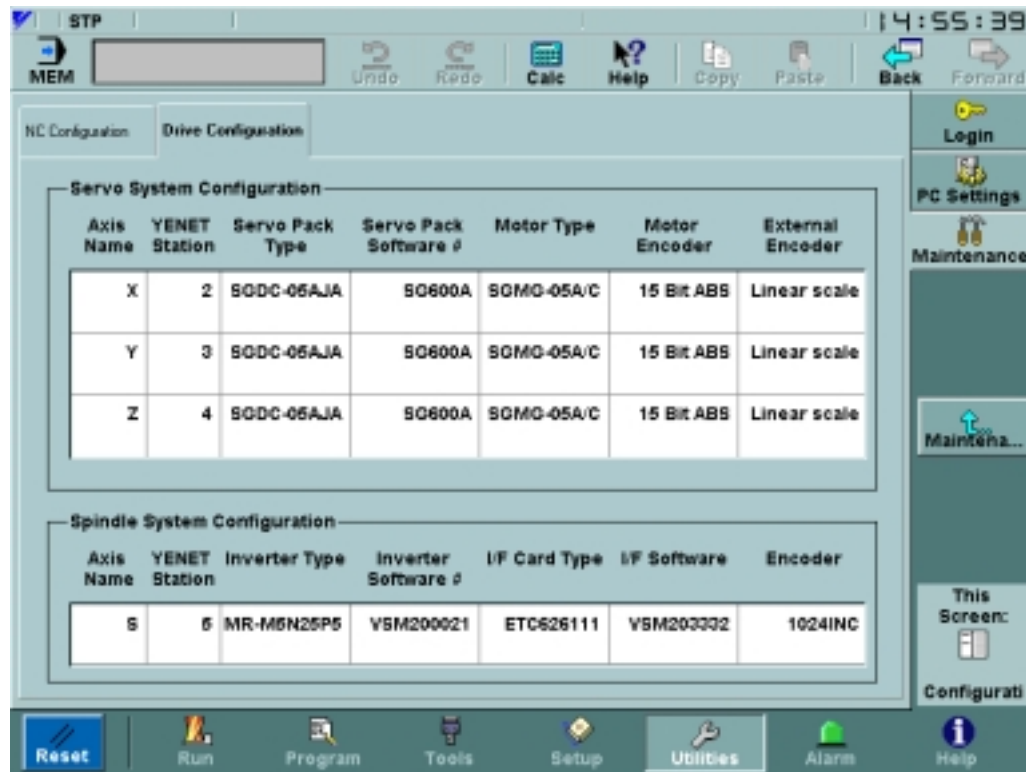

FIGURE 3.7.4.2. Configuration Screen - Drive Configuration

The **Drive Configuration** tab of the *Maintenance:Configuration* screen, shown in Figure 3.7.4.2 on page 67, displays the types of servo packs and servo motors installed on the NC. This information is for display purposes only and is not editable.

Setting the YENET station numbers:

- Go to the **Drive Configuration** tab of the *Maintenance:Configuration* screen to observe the current YENET station numbers. They will be something like “2”, “3” and “4”.
- Switch to the *Utilities:Login* screen and log in as Machinist (or higher).
- Change to the *Maintenance:Parameter Search* screen and check the **Search** checkbox in the top left corner of the screen. Set the search kind to **Label**, then type in “station number” and hit **Enter**. This should display all the YENET station number parameters.
- Change the station numbers for the 1st, 2nd and 3rd axes (pm 1020 -1022) by selecting new values in the drop-down menus.
- Press reset, then shut down and boot up the PCNC.
- Go to the **Drive Configuration** tab of the *Maintenance:Configuration* screen to see the changed station numbers.

3.7.5 Backup and Restore Screen

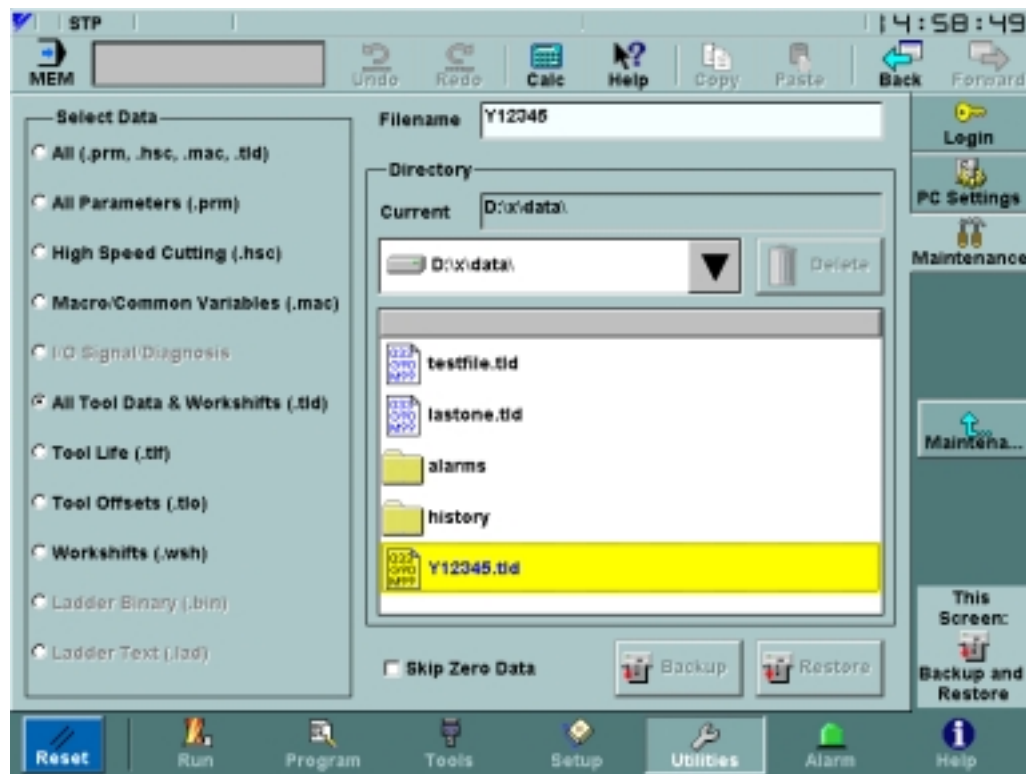

FIGURE 3.7.5.1. The Backup and Restore Screen

The *Maintenance:Backup and Restore* screen is used to upload and download files from the CNC to the PC. Certain features on this screen are password protected and require Machinist level or higher to access them. Users logged in at Operator level have the ability to backup and restore tool and workshift data only.



The **Delete** button is used to remove any older backup files that may no longer be needed.



The **Backup** button starts the backup process, copying values of the selected data type into the **Filename** and **Directory** specified.



The **Restore** button starts the restore process, copying values of the selected data type from the **Filename** and **Directory** specified.

The **Delete**, **Backup** and **Restore** buttons will be disabled if the **Enable Parameter Changes** switch on the *Utilities:Login* screen is not checked. They will also be disabled if Edit Lock is on.

During backup and restore operations, the dialog shown in Figure 3.7.5.2 on page 69 is displayed. It requests confirmation before starting the backup/restore, lists each file as it is backed up or restored, posts a message when the process is complete, and displays any error messages. In addi-

tion, a Reset  button is provided to cancel the backup/restore process. This button should be used with caution, however, because pressing Reset during a restore can give unpredictable results.

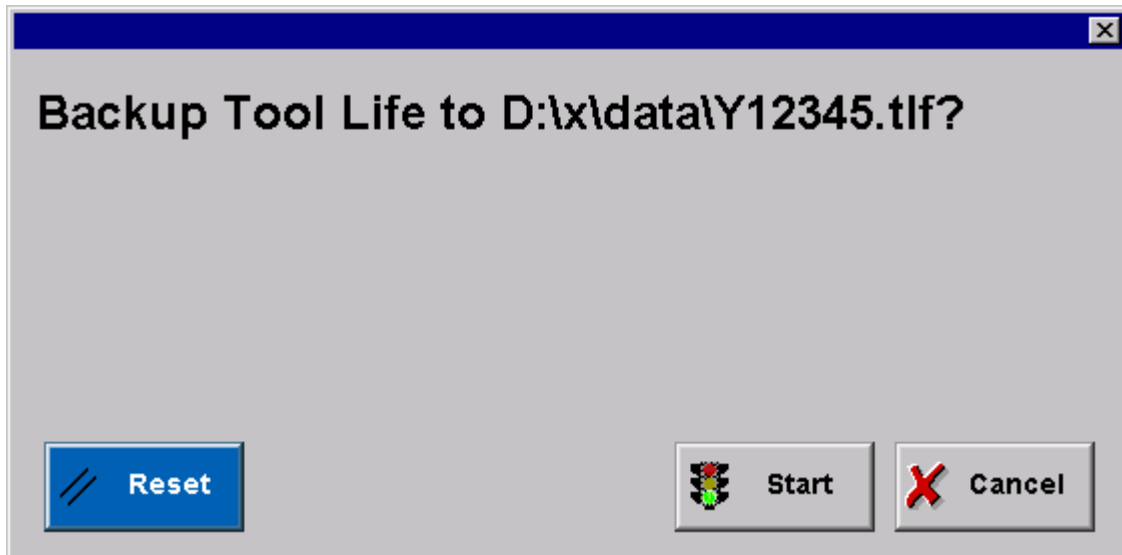



FIGURE 3.7.5.2. The Backup/Restore Status Dialog

The Select Data box is used to specify the data to be transmitted. This filters the files shown in the file list, so that only folders and files with the appropriate extension are displayed. The All Tool Data & Workshifts option includes all Tool Life, Tool Offsets and Workshifts data. The All option creates four files: All Parameters, High Speed Cutting, Macro/Common Variables and All Tool Data & Workshifts.

If the **Skip Zero Data** switch is set, no 0 data is output, thus reducing the size of the backup file.

Backing up workshift data:

- Touch the **Workshifts (.wsh)** radio button in the **Select Data** box.
- Use the file browser to navigate to the directory where the backup file should be saved.
- If an workshifts backup file already exists, selecting that file in the list will replace its contents when the backup occurs. To save the backup to a new file, type in a new name in the **Filename** field at the top of the screen.
- To prevent zero data from being written, check the **Skip Zero Data** checkbox.
- Click the **Backup**  button to start the backup process.
- Click the **Start** button on the dialog that appears.
- Click the **Close** button when the “Backup completed” message is shown.

Restoring all tool data and workshifts:

- Touch the **All Tool Data & Workshifts (.tld)** radio button in the **Select Data** box.
- Use the file browser to navigate to the directory where the backup file was saved.

- Select the backup file from the list.
- Click the **Restore**  button to start the restore process.
- Click the **Start** button on the dialog that appears.
- Click the **Close** button when the “Restore completed” message is shown.

3.7.6 CPU Monitor Screen

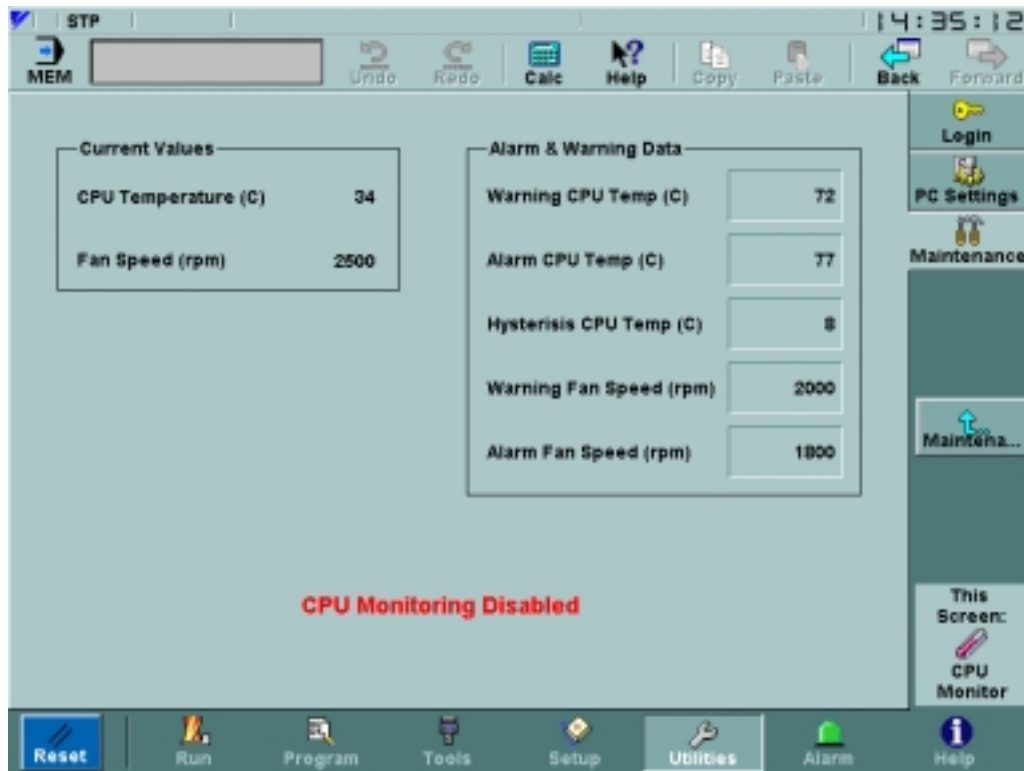

FIGURE 3.7.6.1. The CPU Monitor Screen

The *Maintenance:CPU Monitor* screen, shown in Figure 3.7.6.1 on page 70, is used to monitor fan speed and temperature for the CPU. Current temperature and fan speed values are displayed on the left, while text fields in the **Alarm & Warning Data** box on the right are used to control when alarms and warnings are shown. These text fields may be edited by any user with Manager or higher access. Changes will stay in effect until the next time the power is cycled.

A warning is generated whenever the CPU temperature reaches the **Warning CPU Temp**. When the CPU temperature reaches **Alarm CPU Temp** an alarm will occur. The **Hysteresis CPU Temp** is used to control when an alarm will disappear after the temperature starts to decrease. Once the temperature starts to drop, the alarm will exist until the CPU temperature reaches (**Alarm CPU Temp – Hysteresis CPU Temp**). The system generates a warning when the fan RPM falls under the **Warning Fan Speed**, and an alarm occurs when the fan speed drops below **Alarm Fan Speed**.

3.7.7 Setting Parameters Screen

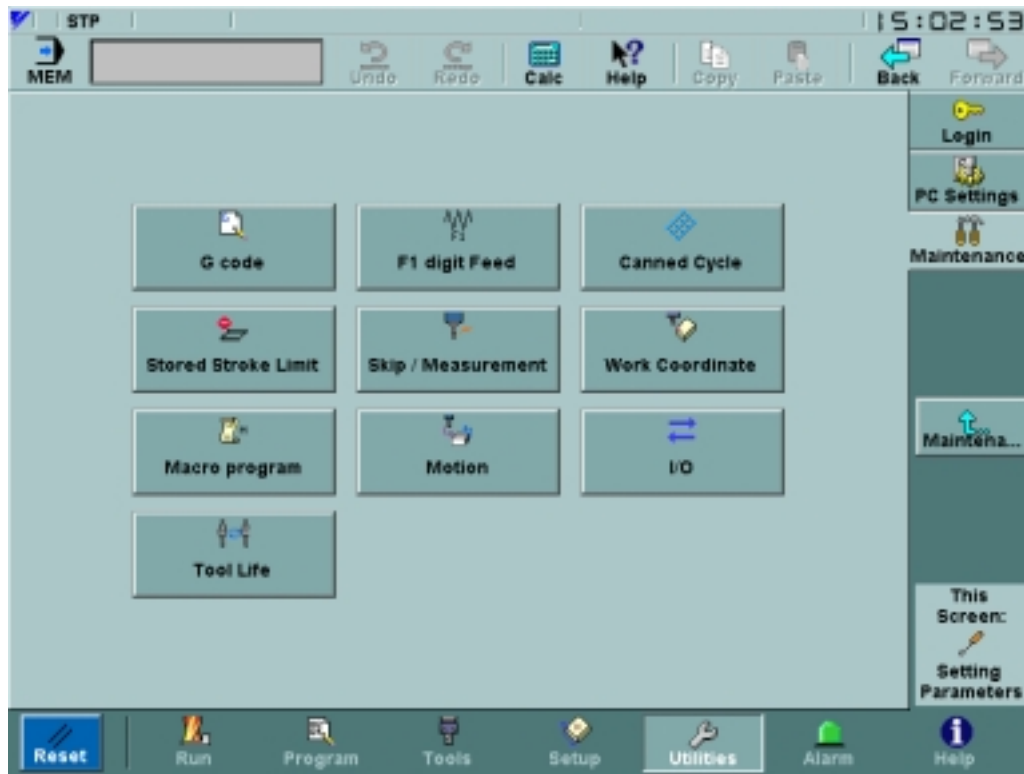

FIGURE 3.7.7.1. The Setting Parameters Screen

The *Maintenance:Setting Parameters* screen is a jumping point to several screens where specific setting parameters (parameters with addresses under 1000) may be viewed and modified. The operation of each of these screens is identical; just the parameters which are shown on each screen vary. Therefore, only the *G Code Setting Parameters* screen, displayed in Figure 3.7.7.2 on page 72, will be shown here as an example of these screens.

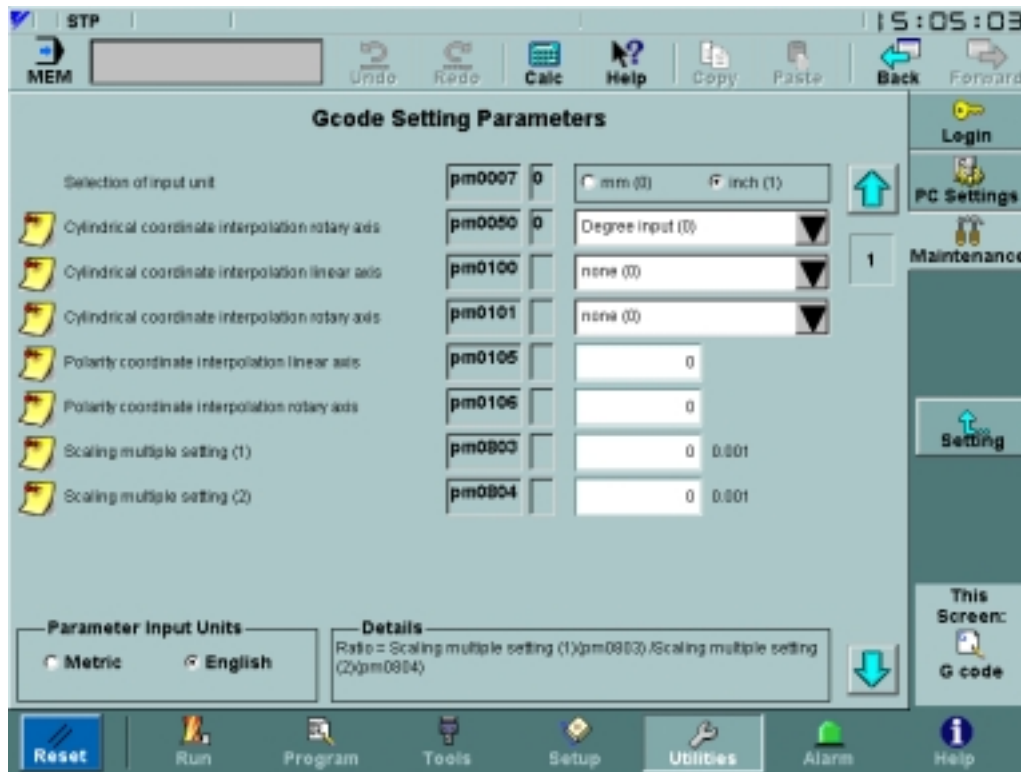



FIGURE 3.7.7.2. The G-code Setting Parameters Screen

The *G-code Setting Parameters* screen is used for viewing and editing setting parameters pertaining to G codes. Each line of the table contains a parameter description, address, bit offset, and parameter value. If the parameter is stored as a byte or multiple bytes, the bit offset field is left blank.

Occasionally, a parameter may have additional information attached to it. When this occurs, a note icon  appears to the left of the parameter. Clicking on the parameter label displays the additional information in the **Details** box at the bottom right corner of the screen. While address, bit offset and description are non-editable parts of the table, the values displayed on the right side of the screen may or may not be editable, depending upon user level. When a parameter is changed, a confirmation dialog similar to the one in Figure 3.7.7.3 on page 73 is shown. The **Don't show this again** switch may be used to prevent the confirmation dialog from appearing. The **Units** box controls whether the displayed values are in **English** or **Metric** units.

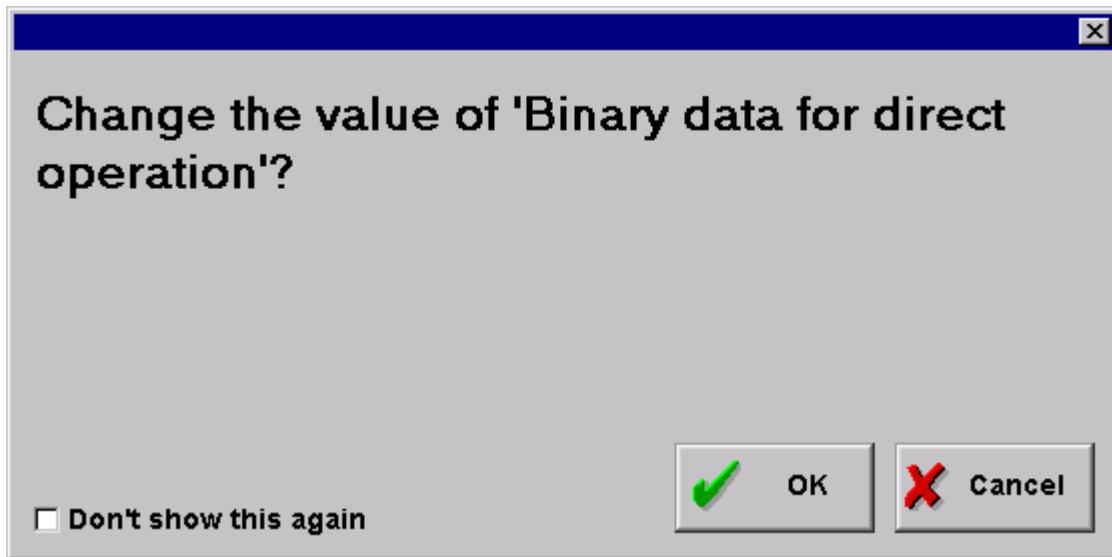



FIGURE 3.7.7.3. The Parameter Change Confirmation Dialog

The arrows to the right of the table are used to scroll up  and down  through the table. In addition, if more than one page of parameters exists, the currently shown page can be set by clicking the corresponding page number button shown between the scrolling arrows.

3.7.8 NC Parameters Screen

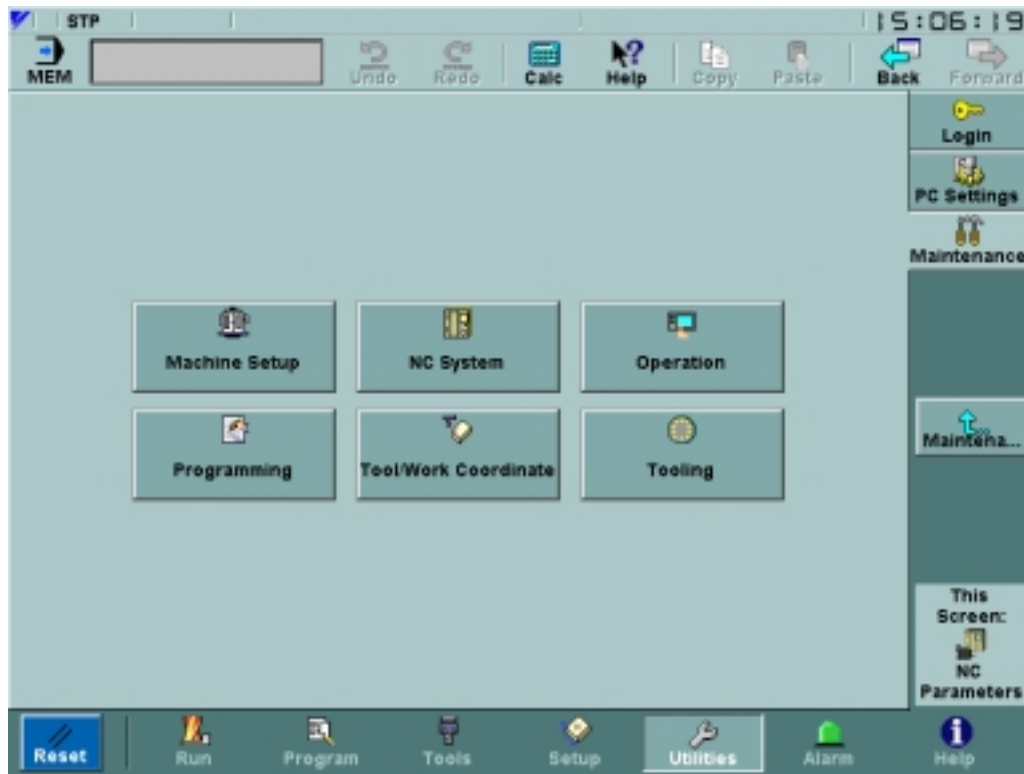

FIGURE 3.7.8.1. The NC Parameters Screen

The *NC Parameters* screen provides jumping points to several screens where specific parameters with addresses above 1000 may be viewed and modified. The operation of each of these screens is identical; only the parameters which are shown on each will vary. The *G Code Setting Parameters* screen, displayed in Figure 3.7.7.2 on page 72, is representative of the appearance and behavior of these screens.

3.7.9 Machine Setup Screen

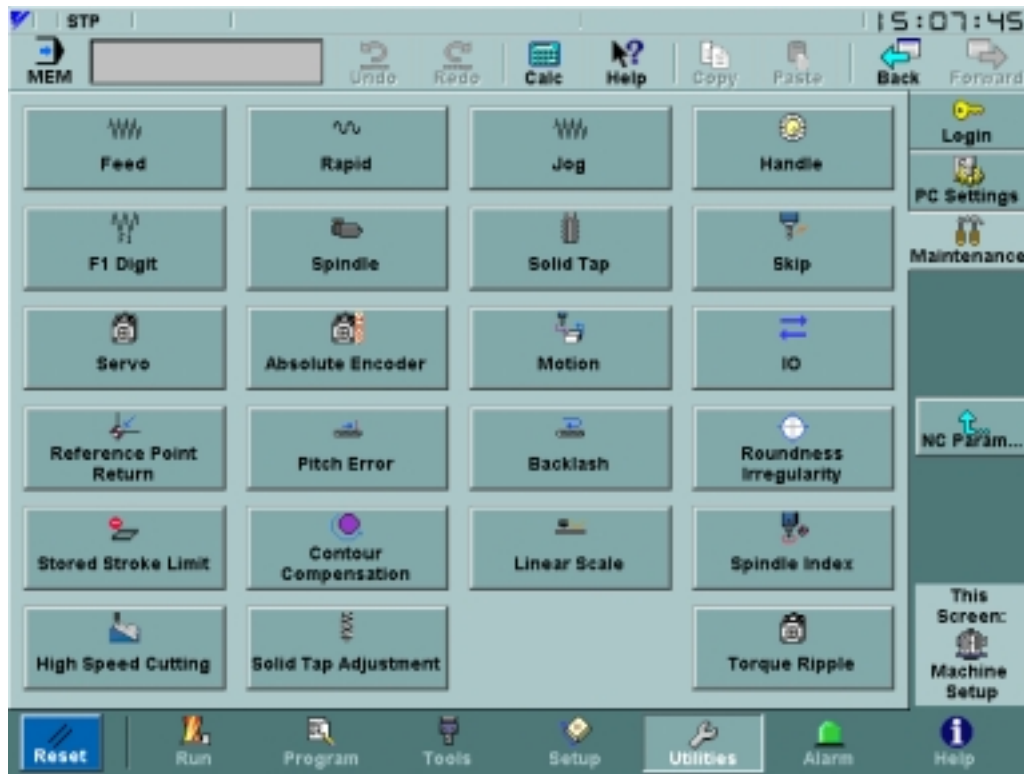

FIGURE 3.7.9.1. The Machine Setup Screen

The *NC Parameters:Machine Setup* sub-screen, Figure 3.7.9.1 on page 75, also provides jumping points to several screens where specific parameters with addresses above 1000 may be viewed and modified. The operation of each of these screens is identical; only the parameters which are shown on each will vary. The *G Code Setting Parameters* screen, displayed in Figure 3.7.7.2 on page 72, is representative of the appearance and behavior of these screens. In addition, there are two other screens, discussed next, that can be reached from *NC Parameters:Machine Setup*.

3.7.10 Pitch Error Screen

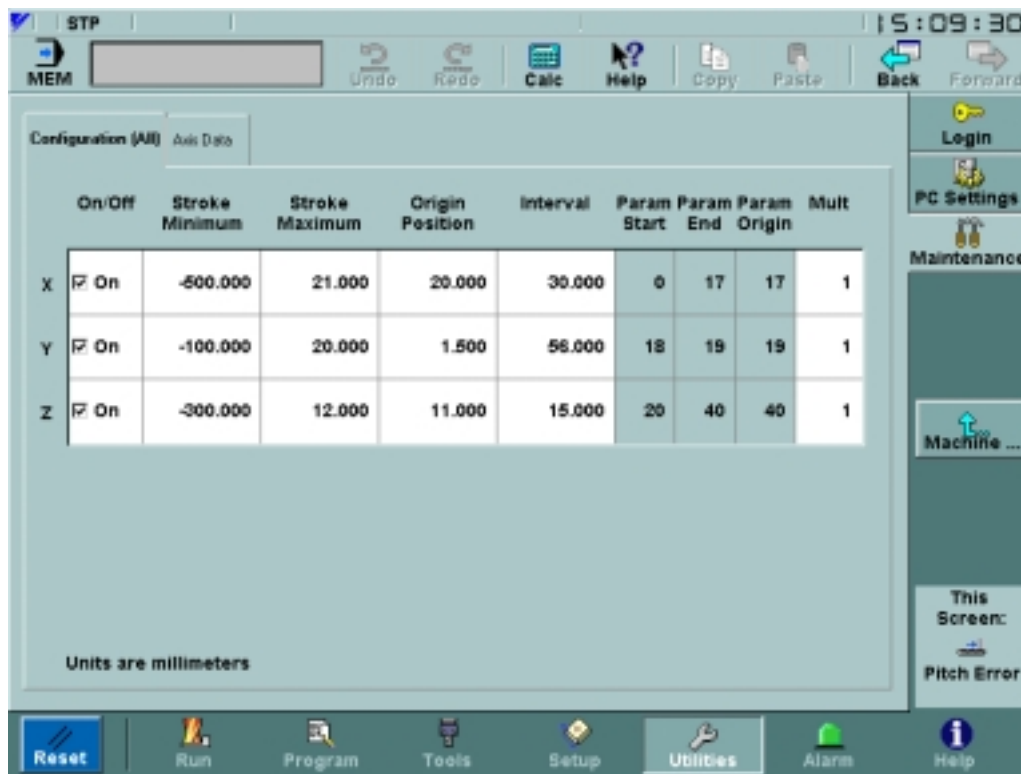

FIGURE 3.7.10.1. Configuration Data Tab of the Pitch Error Screen

The *Machine Setup:Pitch Error* screen is used to display and set the pitch error compensation data that is stored in the NC. This screen is only accessible by users at Machinist level or higher.

The **Configuration** tab controls the range and size of the pitch error intervals. **Param Start**, **Param End**, and **Param Origin** indicate the corresponding pitch error points for each axis. They are automatically calculated from **Stroke Minimum**, **Stroke Maximum**, **Origin Position** and **Interval** whenever any of these values change. Using the **Origin Position**, points are added at positive and negative multiples of **Interval** within the range from **Stroke Minimum** to **Stroke Maximum**. For all axes there can be a combined total of 1152 pitch error points.

The Axis Data tab, Figure 3.7.10.2 on page 77 shows pitch error points for an individual axis, which is set using the **Axis** drop-down menu. **Multiply**, **Origin point**, and **Origin position** are data reproduced from the **Configuration** tab for convenience. The table on the right half of the screen shows all pitch error points for the axis, from **Param Start** to **Param End**. For each point, position (calculated from **Configuration** tab values) and value are shown. Only **Value** is editable, and it can range from -127 to +127. The origin position is highlighted in the table.

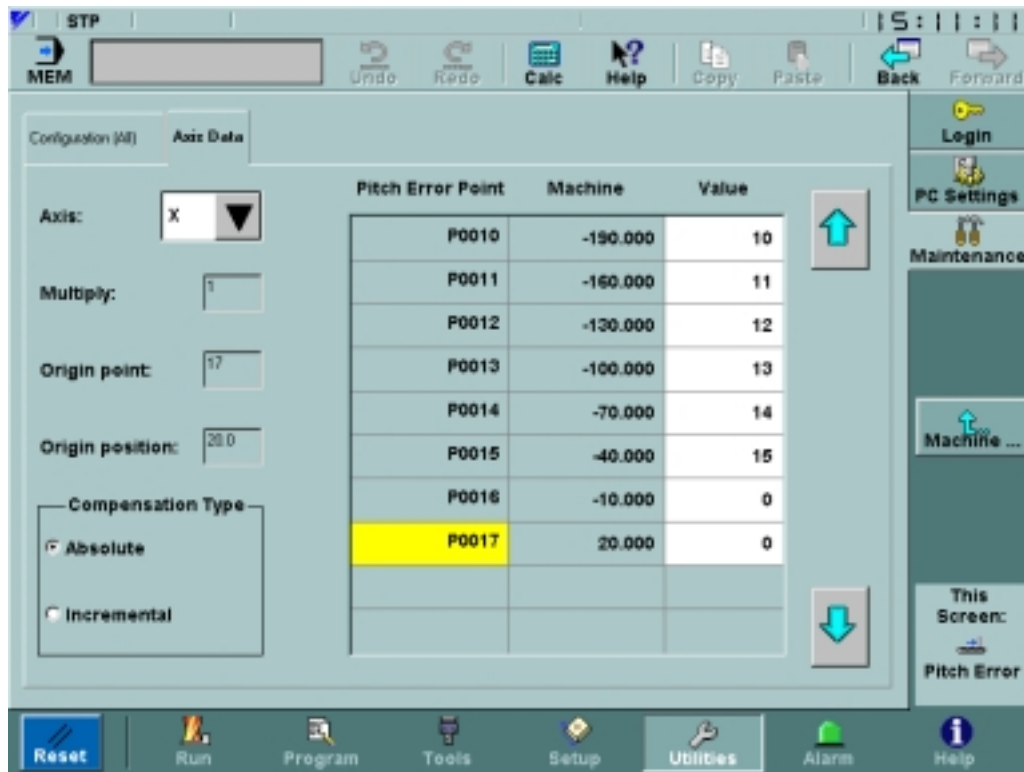

FIGURE 3.7.10.2. Axis Data Tab of the Pitch Error Screen

3.7.11 Solid Tap Screen

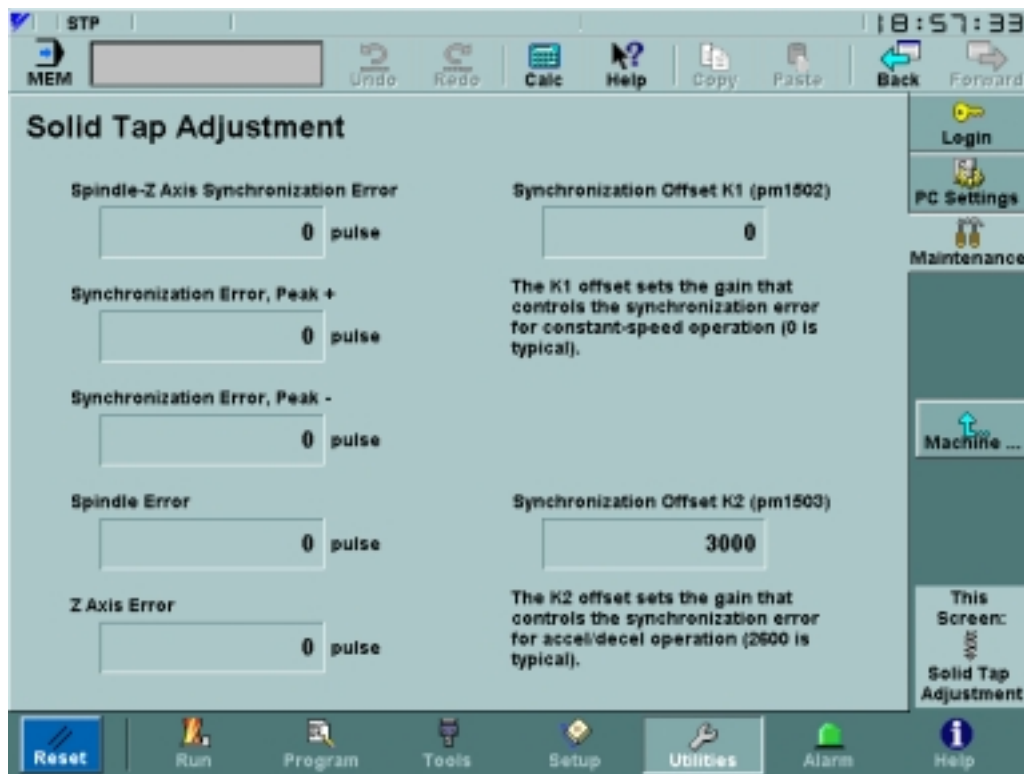

FIGURE 3.7.11.1. The Solid Tap Screen

The *Machine Setup:Solid Tap* screen is used to adjust the gains in order to minimize error for the solid tap process. The left side of the screen displays real-time data about solid tap performance. These fields will show 0 if not doing solid tap. The **Synchronization Offset** fields on the right half of the screen are editable by any user at MTB level or higher. Parameter editing must be enabled on the *Utilities:Login* screen to make any changes.

3.7.12 Torque Ripple Screen

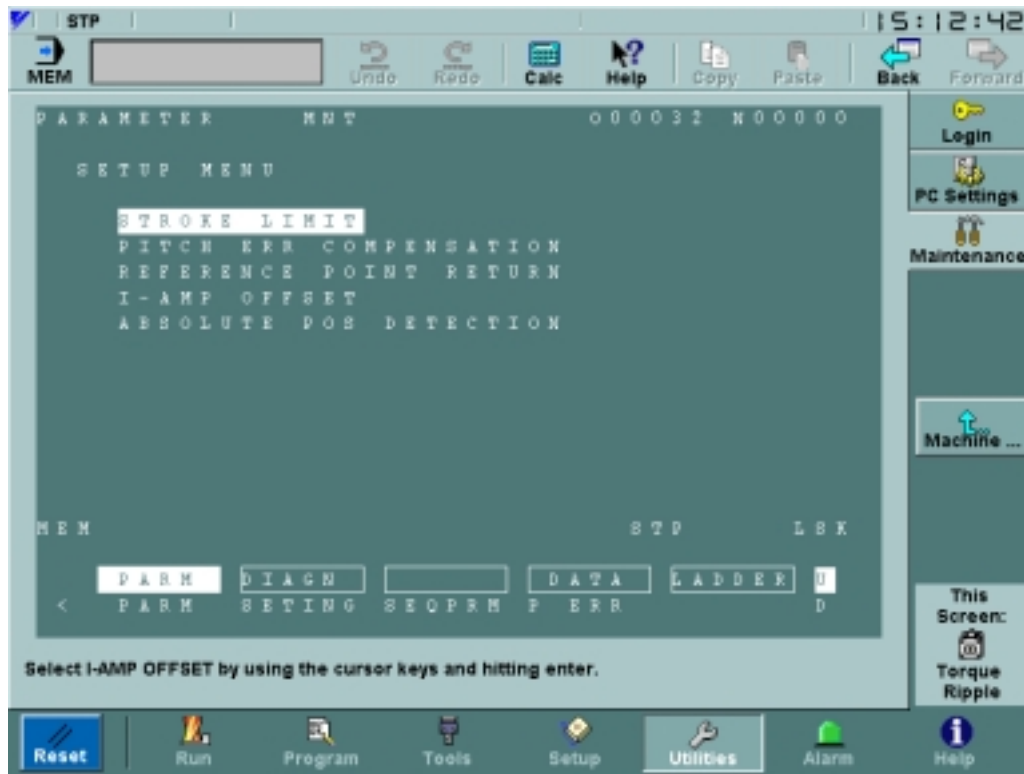

FIGURE 3.7.12.1. The Torque Ripple Screen

The *Torque Ripple* screen, shown in Figure 3.7.12.1 on page 79, will only be shown for Machinist level or higher. It can be accessed from *Utilities:Maintenance:NC Parameters:Machine Setup* screen.

3.7.13 Parameter Search Screen

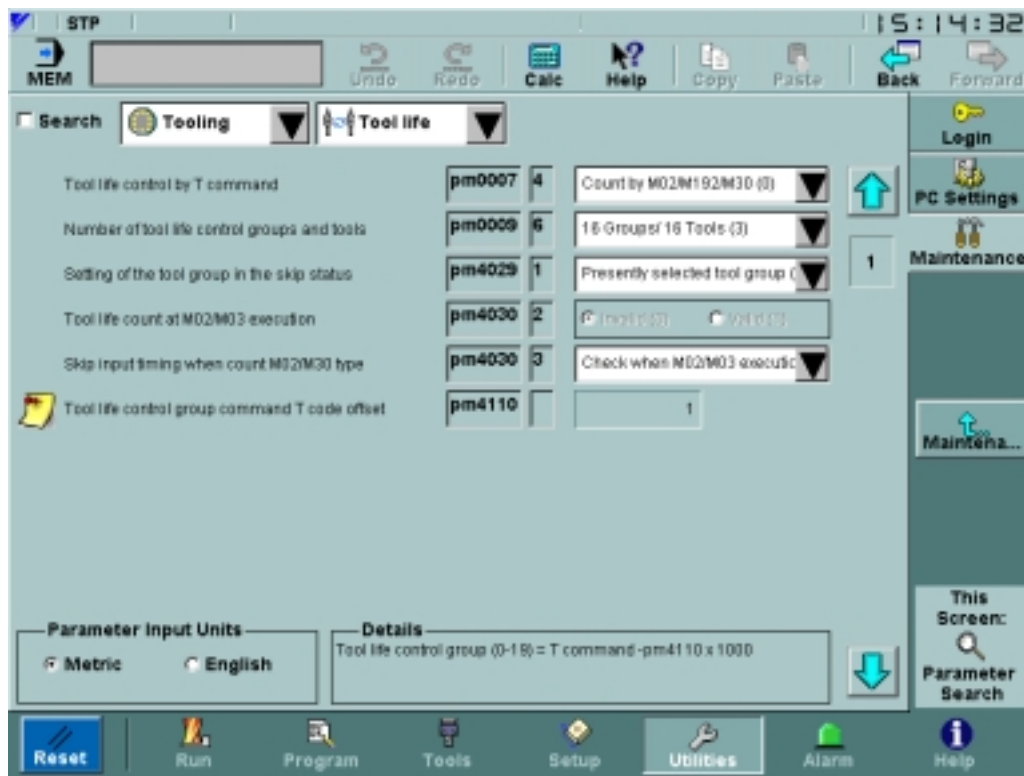

FIGURE 3.7.13.1. The Parameter Search Screen with Drop-down Menus

The *Maintenance:Parameters Search* screen is used for viewing and editing CNC parameters. When the **Search** switch is not checked, the drop-down menus along the top of the screen are used to specify which parameters are to be viewed. As drop-down menus are set, new ones appear to the right while the display becomes more specific and shows less parameters. An example of this type of *Parameters* screen is shown in Figure 3.7.13.1 on page 80.

When the **Search** switch is checked, either the **Address** or **Label** can be used to limit the group of parameters shown. Figure 3.7.13.2 on page 81 is an example of this type of *Parameters* screen. The **Address** option is used to specify the first parameter in the range of parameters (from the starting address to the starting address plus ten) to be shown. For example, if 1100 is entered, all existing parameters from 1100 to 1110 would appear. To use this, type a value into the text field and hit the **Enter** key.



Similarly, all parameters with labels containing a certain string may be displayed via the **Label** option.



FIGURE 3.7.13.2. The Parameter Search Screen with Text Search

Parameter number and description are non-editable parts of the table. However, the values displayed on the right side of the screen may or may not be editable, depending upon user level and if the **Enable Parameter Changes** switch on the *Utilities:Login* screen is checked. The **Parameter Input Units** box controls whether the displayed values are in **English** or **Metric** units.

Occasionally, a parameter may have additional information attached to it. When this occurs, a note icon  appears to the left of the parameter. Clicking on the parameter label displays the additional information in the box at the bottom right corner of the screen.

The arrows to the right of the table are used to scroll up  and down  through the table. In addition, if more than one page of parameters exists, the currently shown page can be set by clicking the corresponding page number button shown between the scrolling arrows.

3.7.14 High Speed Cutting Screen

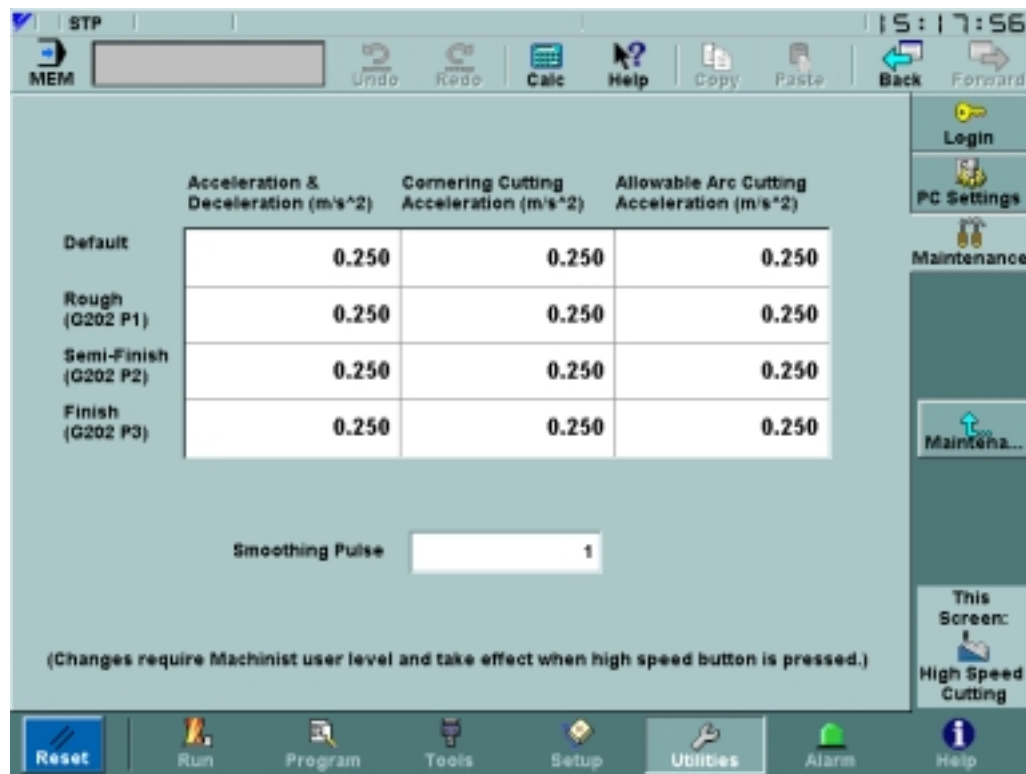

FIGURE 3.7.14.1. The High Speed Cutting Screen

The *High Speed Cutting* screen is used for viewing and editing setting parameters pertaining to high speed mode. See “Backup and Restore Screen” on page 68 and the following example for information on saving and importing this data.

Saving and loading HSC parameters:

- Login as Machinist or higher.
- Go to the *Utilities:Maintenance:High Speed Cutting* screen.
- Select the grid cell with the row labeled **Default** and the column labeled **Acceleration & Deceleration (m/s²)**. The border of the cell should now have black line.
- Type ".123" and press **Enter**. The number field will turn yellow while editing and become white again when **Enter** is pressed.
- Switch to the *Maintenance:Backup and Restore* screen and backup the high speed cutting parameters.
- Return to the *Utilities:Maintenance:High Speed Cutting* screen.
- Select the grid cell with the row labeled **Default** and the column labeled **Acceleration & Deceleration (m/s²)**. The border of the cell should now have black line.
- Type ".456" and press **Enter**. The number field will turn yellow while editing and become white again when **Enter** is pressed.
- Switch to the *Maintenance:Backup and Restore* screen and restore the high speed cutting parameters that were just backed up.

- Go back to the *Utilities:Maintenance:High Speed Cutting* screen. The grid cell with the row labeled **Default** and the column labeled **Acceleration & Deceleration (m/s²)** again reads "0.123."

3.7.15 User Install Screen

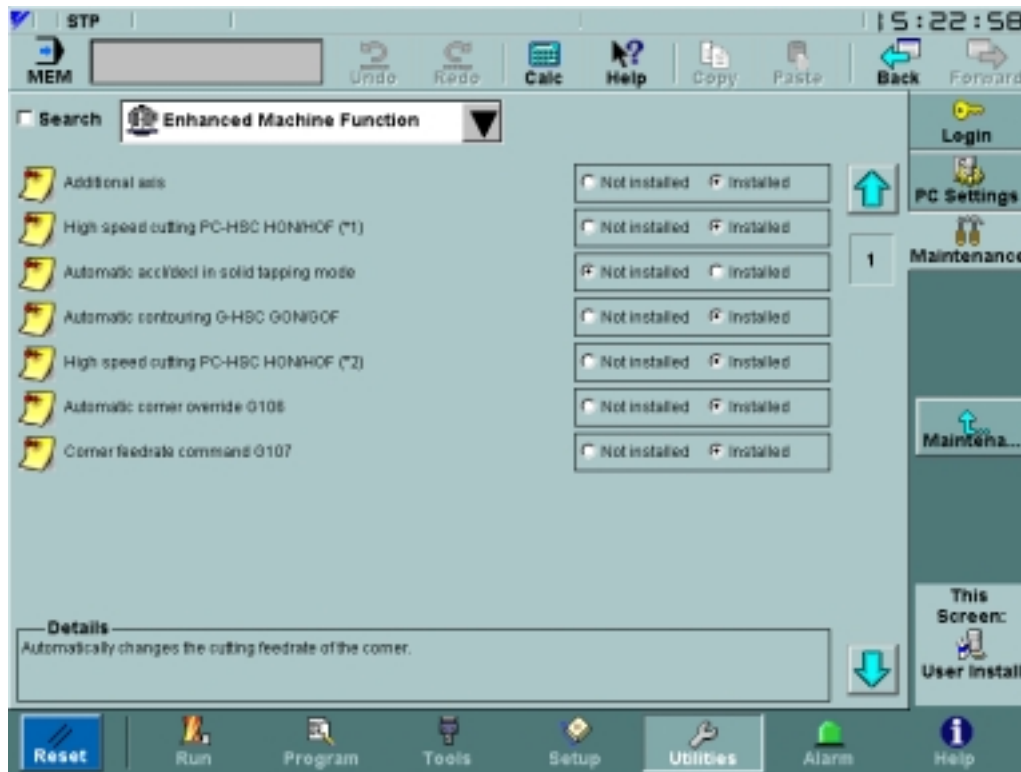

FIGURE 3.7.15.1. The User Install Screen Using Drop Down Menus

The *User Install* screen, shown in Figure 3.7.15.1 on page 83, is used by shop personnel to install CNC software options. These options are divided into groups by functionality, and when the **Search** switch is not checked, groups are shown in the drop down menu in the upper left corner. When the **Search** switch is checked, it is possible to show only the options whose descriptions contain a specified string. An example of this is shown in Figure 3.7.15.2 on page 84, where only options whose descriptions contain ‘coord’ are shown. To use this feature, type a string into the text field and hit the **Enter** key. Searching by **Address** is not enabled for this screen.

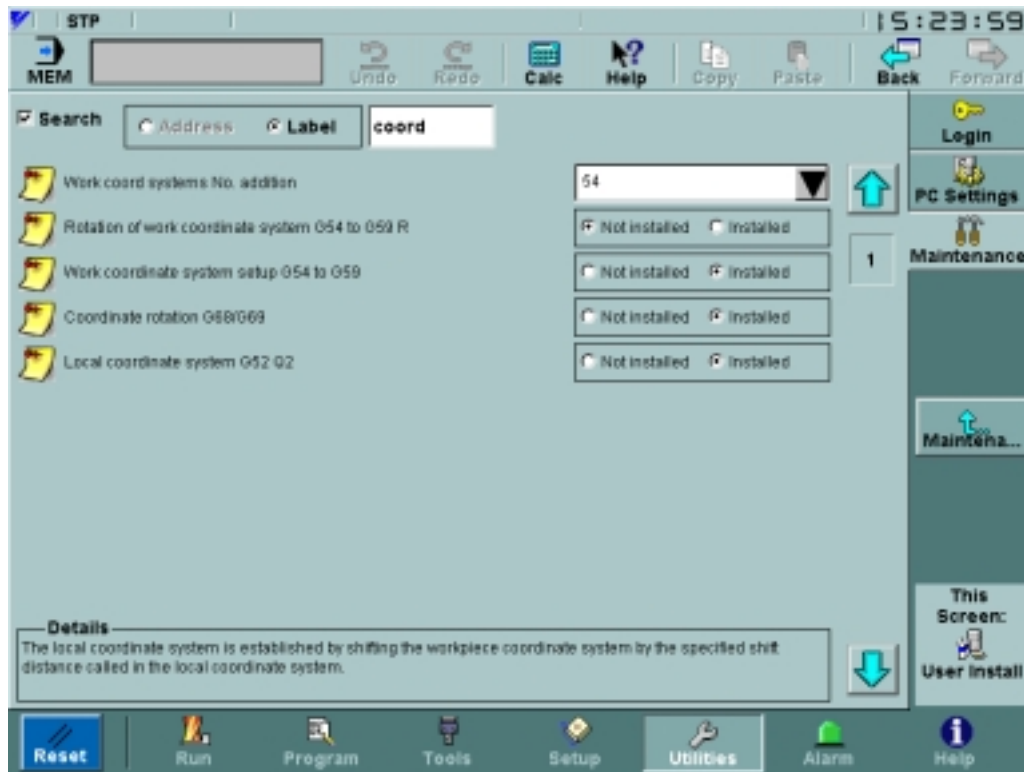

FIGURE 3.7.15.2. The User Install Screen Using Search

Parameter labels are non-editable parts of the table, but the values displayed on the right side of the screen may or may not be editable, depending upon user level and if the **Enable Parameter Changes** switch on the *Utilities:Login* screen is checked. When an item’s value is changed, a dialog (such as the one in Figure 3.7.15.3 on page 85) will appear to confirm the operation and possibly request an authorization code.

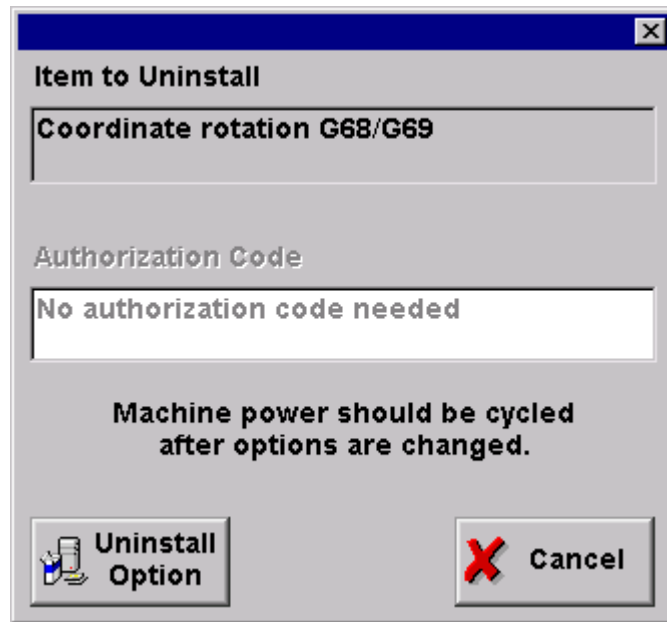





FIGURE 3.7.15.3. Install Dialog

Occasionally, a parameter may have additional information attached to it. When this occurs, a note icon  appears to the left of the parameter. Clicking on the parameter label displays the additional information in the box at the bottom right corner of the screen.

The arrows to the right of the table are used to scroll up  and down  through the table. In addition, if more than one page of options exists, the currently shown page can be set by clicking the corresponding page number button shown between the scrolling arrows.

3.7.16 MTB Install Screen

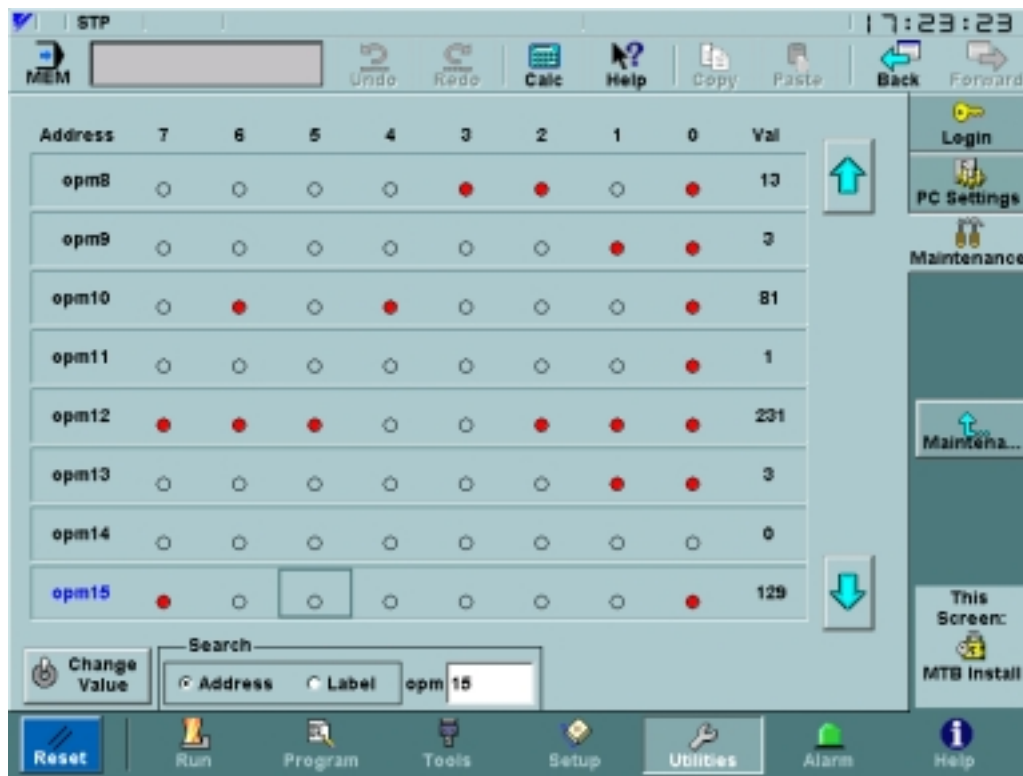







FIGURE 3.7.16.1. The MTB Install Screen

The *MTB Install* screen, shown in Figure 3.7.16.1 on page 86, is used by the machine tool builder to install CNC software options. This screen cannot be accessed unless the user level is MTB or higher.

Each line of the table displays the individual bits for the byte at the address shown in the left-most column. Setting the values of single bits and combinations of bits will control which options are installed. Touching a bit will select it, and the selected state is indicated by a rectangular box surrounding the bit. Only one bit may be selected at a time. Selected bits can be turned on and off by pressing the **Change Value**  button. A bit that is ON has a filled red circle , while a bit that is off has an empty black circle .

It is also possible to change the value of a byte, by touching on the decimal representation in the **Val** column. An edit field will appear, and any value in the range 0 to 255 may be entered. If a new value is typed in, but the **Enter** key is not pressed, the byte will revert to its previous value. Otherwise, the individual bits will change to reflect the new value.

The list of bytes may be searched using the byte **Address**. To use this feature, type an address into the search field and hit the **Enter** key. When a match is found, the address is shown in blue. If necessary, the list will be scrolled so that the address is visible.

The arrows to the right of the table are used to scroll up  and down  through the table.

3.7.17 PLC Parameters Screen

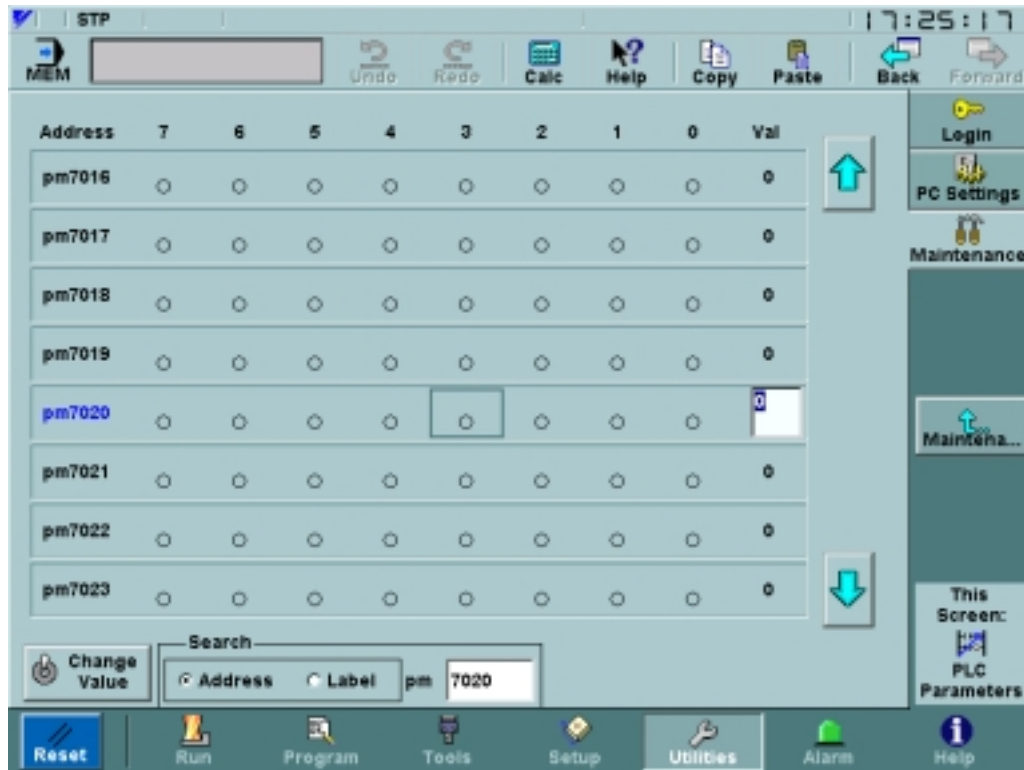

FIGURE 3.7.17.1. The PLC Parameters Screen

The *Maintenance:PLC Parameters* screen, shown in Figure 3.7.17.1 on page 87, is used to view and set PLC parameters. This screen cannot be accessed unless the user level is Machinist or higher.

The appearance and operation of this screen is identical to that of the *MTB Install* screen; only the shown parameters are different. Therefore, for specifics on how to use this screen, see “MTB Install Screen” on page 86.

Change Value may or may not be enabled, depending upon user level and if the **Enable Parameter Changes** switch on the *Utilities:Login* screen is checked.

3.7.18 PLC Diagnosis Screen



FIGURE 3.7.18.1. The All Diagnosis Tab of the PLC Diagnosis Screen

The *Maintenance:PLC Diagnosis* screen, shown in Figure 3.7.18.1 on page 88, is used to view and edit PLC diagnosis parameters. This screen has two tabs: **All Diagnosis**, which can display any group of diagnosis parameters, and **Display Selected**, which shows only diagnosis parameters that are explicitly chosen.

Both tabs have a table that contains byte information. Each line of the table displays the individual bits for the byte at the address shown in the left-most column. A bit that is on is indicated by a filled red circle ●, while an empty black circle ○ denotes a bit that is off. The arrows to the right of the table are used to scroll up ▲ and down ▼ through the table.

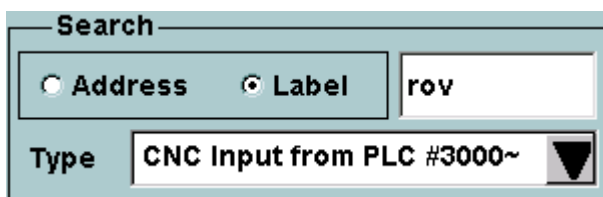

The **Search** box at the bottom of the *PLC Diagnosis* screen controls which items are displayed in the **All Diagnosis** tab. This box is disabled for the **Display Selected** tab. The **Type** drop-down menu is used to set the address range of the items to show. The items within the set address range can be searched

for a string matching the **Label** of an individual bit, or *all* PLC diagnosis parameters may be searched for a specific address. To use this feature, select the search kind, then type a value into

the search field and hit the **Enter** key. When a match is found, the address is shown in blue. If necessary, the list will be scrolled so that the address is visible.

If no label contains the text in a **Label** search, a “No match found” message will appear in the warning area. If the address entered in an **Address** search is invalid, an “Address out of range” warning will be shown.

A byte is shown in the **Display Selected** tab if it is chosen by pressing the checkbox to the left of its address. Unchecking this box will remove it from the selected bytes list. The **Display Selected** tab is especially useful for monitoring a non-consecutive group of parameters of varying types. An example of this is shown in Figure 3.7.18.2 on page 90.

Configuring and clearing the display selected tab:

- Go to **All Diagnosis** tab of the *Maintenance:PLC Diagnosis* screen.
- In the **Search** box, set the **Type** to “CNC Output to PLC #3500~”.
- Touch the boxes to the left of addresses 3500, 3504 and 3505 so that they appear to be checked.
- Touch the **Display Selected** tab. The three address that were just selected should be shown.
- Touch the **Clear All Selections** button. At this point, no bytes should be displayed in the Display Selected tab.
- Switch back to the **All Diagnosis** tab. The boxes next to addresses 3500, 3504 and 3505 are no longer checked.

Selecting multiple diagnosis parameters for display:

- Go to **All Diagnosis** tab of the *Maintenance:PLC Diagnosis* screen.
- In the **Search** box, set the **Type** to “CNC Input from PLC #3000~”.
- Touch the box to the left of address 3002 so that it appears to be checked.
- In the **Search** box, set the **Type** to “PLC Input from Machine #1000~”.
- Touch the boxes to the left of addresses 1000 and 1005 so that they appear to be checked.
- Touch the **Display Selected** tab. The three address that were just selected should be shown. Clicking in the bit display area for each will change the information that is displayed in the **Details** box in the bottom right corner of the screen. Notice that the type data shown in the first line is *not* the same for all three parameters.

In either tab, touching a bit will select it, and this is indicated by a non-black rectangular box surrounding the bit. Only one bit may be selected at a time.

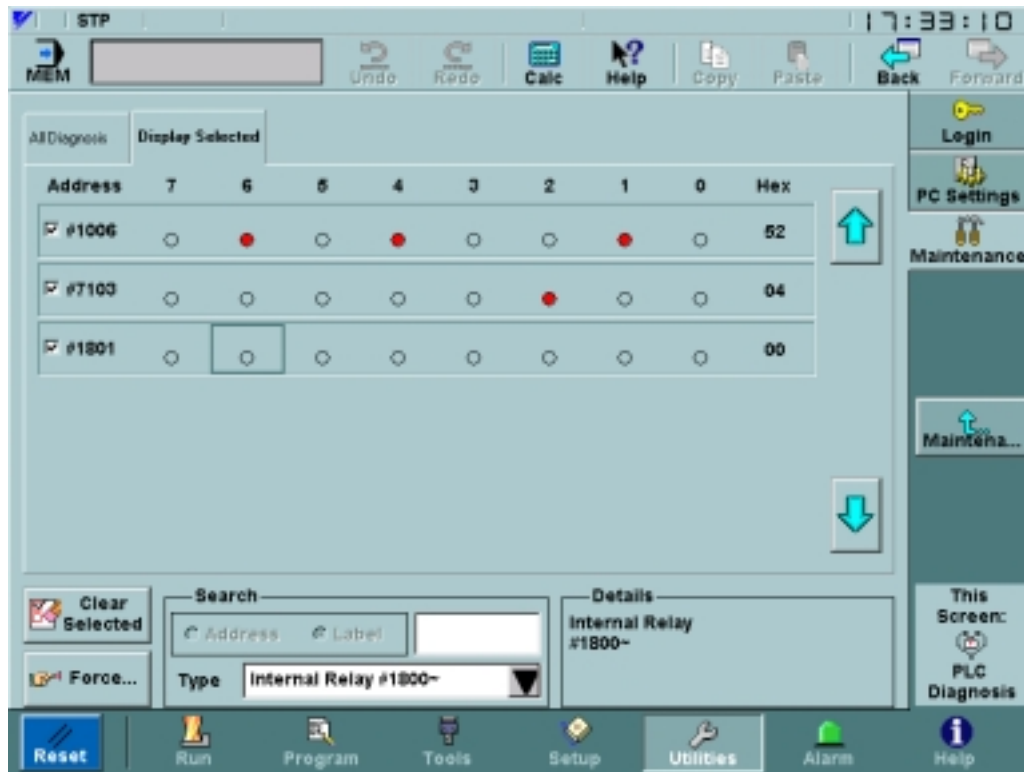
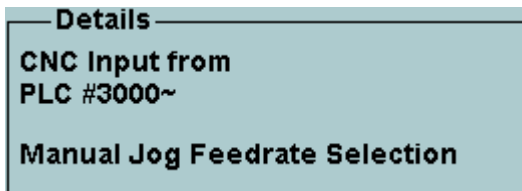



FIGURE 3.7.18.2. The Display Selected Tab of the PLC Diagnosis Screen



The **Details** box provides additional information about individual register bits. When a bit is selected, associated data such as address range and description appear automatically in the **Details** box.

 Selected bits that are not in keep memory (bits with addresses less than 7100) can be turned on and off by pressing the **Force...** button, which pops the *Force I/O* dialog, shown in Figure 3.7.18.3 on page 91. This button is disabled for Operator level.

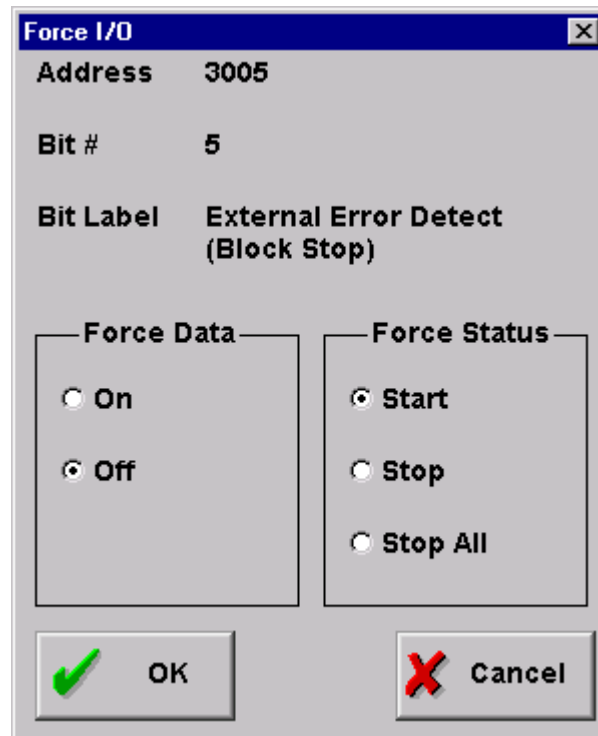

FIGURE 3.7.18.3. The Force I/O Dialog

The top half of the *Force I/O* dialog displays information about the selected bit. In the bottom half, the **Force Status** box is used to control which bits may be forced. Once a bit has been added to the list of forceable bits (by clicking the **Start** radio button), the **Force Data** box becomes enabled. This box is used to set the bit's value to either **On** or **Off**. Selecting the **Stop** radio button (and clicking **OK**) will remove the currently selected bit from the list of forceable bits and reset it to its original value. The **Stop All** radio button removes all bits from the list of forceable bits and sets them back to their original values. A black rectangle surrounds each of the forced bits.

Forcing multiple bits:

- Switch to the *Utilities:Login* screen and log in as Machinist (or higher). Make sure that the **Enable Parameter Changes** box is checked.
- Go to **All Diagnosis** tab of the *Maintenance:PLC Diagnosis* screen.
- In the **Search** box, set the **Type** to "PLC Input from Machine #1000~".
- Select bit 6 of address 1015 by touching it. A rectangular box should now surround the bit.
- Touch the **Force...** button to pop the *Force I/O* dialog.
- Select the **Start** radio button in the **Force Status** box. This will enable the **Force Data** box, thus allowing the bit to be forced.
- Select the **On** radio button, then press **OK**. Bit 6 of address 1015 is now on.
- Select bit 7 of address 1022 by touching it. A rectangular box should now surround the bit. A black rectangle surrounds bit 6 of address 1015 to indicate that it is still being forced.
- Touch the **Force...** button to pop the *Force I/O* dialog.
- Select the **Start** radio button in the **Force Status** box. This will enable the **Force Data** box, thus allowing the bit to be forced.

- Select the **On** radio button, then press **OK**. Bit 7 of address 1022 is now on.
- Select bit 6 of address 1015 by touching it. A black rectangle surrounds bit 7 of address 1022 to indicate that it is still being forced.
- Touch the **Force...** button to pop the *Force I/O* dialog.
- Select the **Stop All** radio button, then press **OK**. There are no longer any black rectangles surrounding bits, and the two forced bits have reverted back to their previous values.

Forcing bits in keep memory (addresses above 7100) is slightly different. When the **Type** drop-down menu is set to either **Keep Relay** or **Keep Memory**, the **Force...** button label changes to **Set...**. Selected bits can now be turned on and off by pressing the **Set...** button, which pops the *Set Keep Memory* dialog, shown in Figure 3.7.18.4 on page 92.

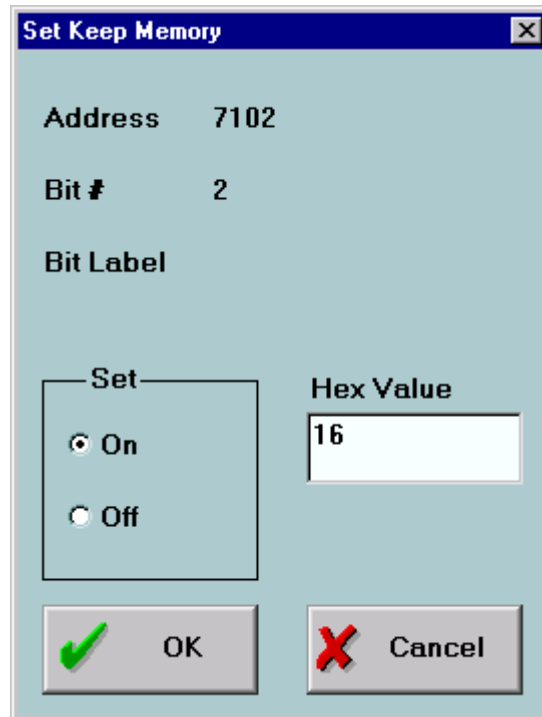

FIGURE 3.7.18.4. The Set Keep Memory Dialog

The upper half of the *Set Keep Memory* dialog displays information about the selected bit. In the lower half, the **Set** box is used to set the bit's value to either **On** or **Off**. The value for the entire byte can be changed by typing a new value into the **Hex Value** field and pressing **Enter**. **OK** will commit changes made while the *Set Keep Memory* dialog is shown; **Cancel** discards any changes made.

3.7.19 Ladder Monitor Screen

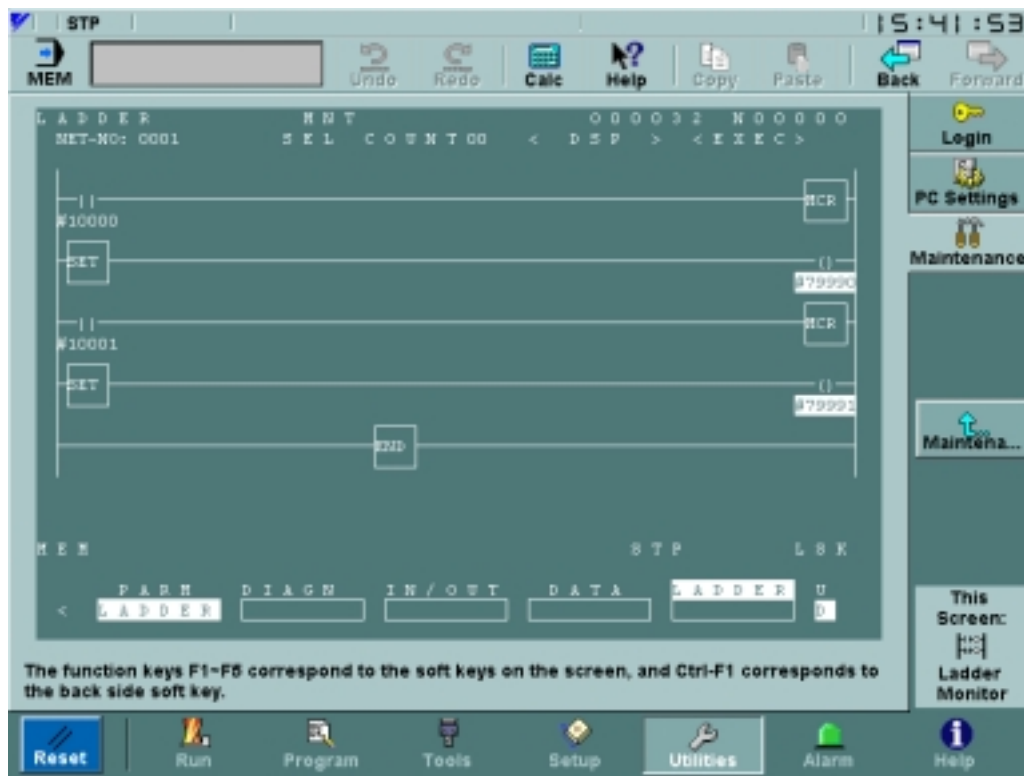

FIGURE 3.7.19.1. The Ladder Monitor Screen

The Ladder Monitor screen, shown in Figure 3.7.19.1 on page 93, is only shown for Machinist level or higher. In this screen, the F1 through F5 soft keys can be used to view and edit the ladder.

3.7.20 Switch Label Screen

The *Switch Label* screen is used to configure the data shown in the *Run:NC Switch* screen, discussed in “NC Switch Screen” on page 33. To use this screen, MTB password or higher is required. Changes made in this screen will affect the *Run:NC Switch* screen immediately.

The **CNC** tab, shown in Figure 3.7.20.1 on page 94, controls which switches in a list of 24 will be in the **CNC Switches** box of the *Run:NC Switch* screen. A switch is displayed if its **Enabled** box is checked. Switch labels, addresses and bits are not editable.

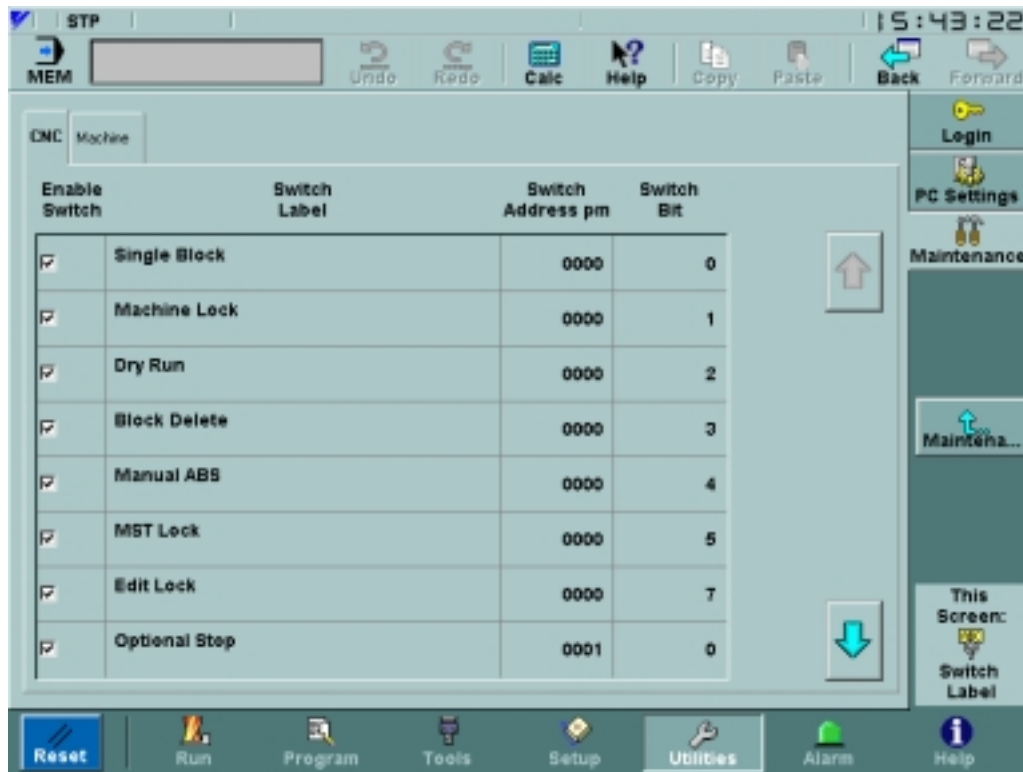

FIGURE 3.7.20.1. The CNC Tab of the Switch Label Screen

The **Machine** tab, shown in Figure 3.7.20.2 on page 95, can be used by machine tool builders to create a software version of the CNC pendant panel in the **Machine Switches** box of the *Run:NC Switch* screen. For each switch shown, there is a label, output keep relay address (**Switch Address** and **Switch Bit**) and LED output keep relay address (**Lamp Address** and **Lamp Bit**). All of these fields are editable. The list can contain a maximum of 16 machine switches. A switch is displayed if its **Enabled** box is checked.



Clicking the **Delete Switch** button while a line in the table is selected will remove that line from the table.

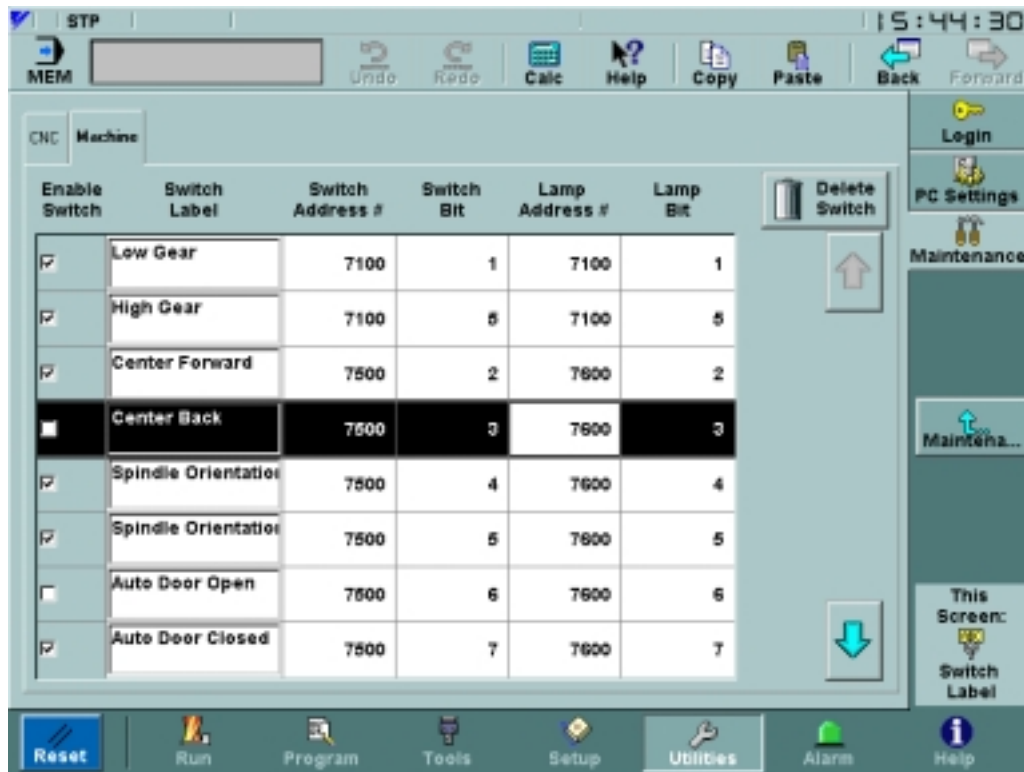

FIGURE 3.7.20.2. The Machine Tab of the Switch Label Screen

3.8 ALARM MENU

3.8.1 NC Alarm Screen

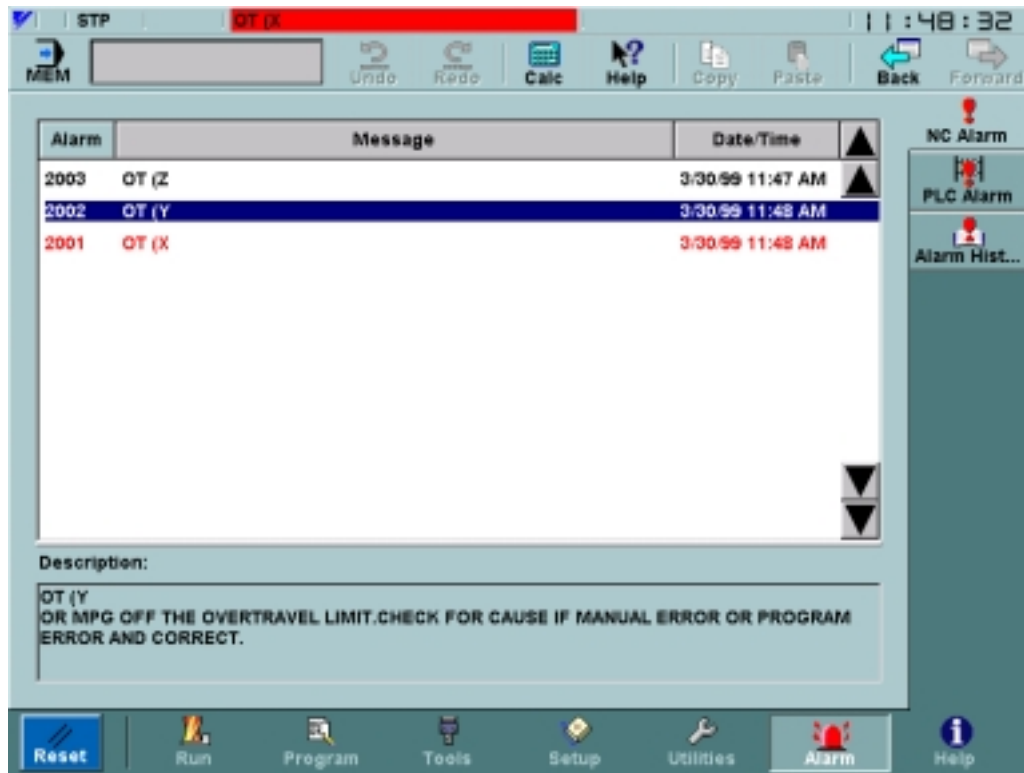



FIGURE 3.8.1.1. The NC Alarm Screen

The *Alarm:NC Alarm* screen, shown in Figure 3.8.1.1 on page 96, displays active alarms. For each active alarm it shows the 4-digit alarm number, alarm message and time signalled. From this table, additional data may be accessed to help determine the cause the problem and possible solutions. Selecting an alarm causes more information to be displayed in the **Description** area below the table. By default, the alarms are sorted and displayed in chronological order with the most recent alarm first. Pressing any of the buttons at the top of the table (i.e., **Alarm**, **Message** or **Time**) will sort the table using the value associated with the button. The button at the top of the column used for sorting is displayed in a different color than the buttons at the top of the other columns.

Causing a macro alarm:

- Go to the *Program:Editor* screen and create and save the following program:

```

000019 (make macro alarm)
#3000=5000(MACRO ALARM TEST)
M30
            
```
- Set this program to be the current  program.
- Execute the program by hitting Cycle Start. The icon for the Alarm menu will turn red, and a short description of the alarm will appear in the Status Bar at the top of the screen.

- Go to the *Alarm:NCAlarm* screen. The alarm “5000 MACRO ALARM TEST” will be displayed in red.
- Select the alarm to display more information in the **Description** area.

3.8.2 PLC Alarm Screen

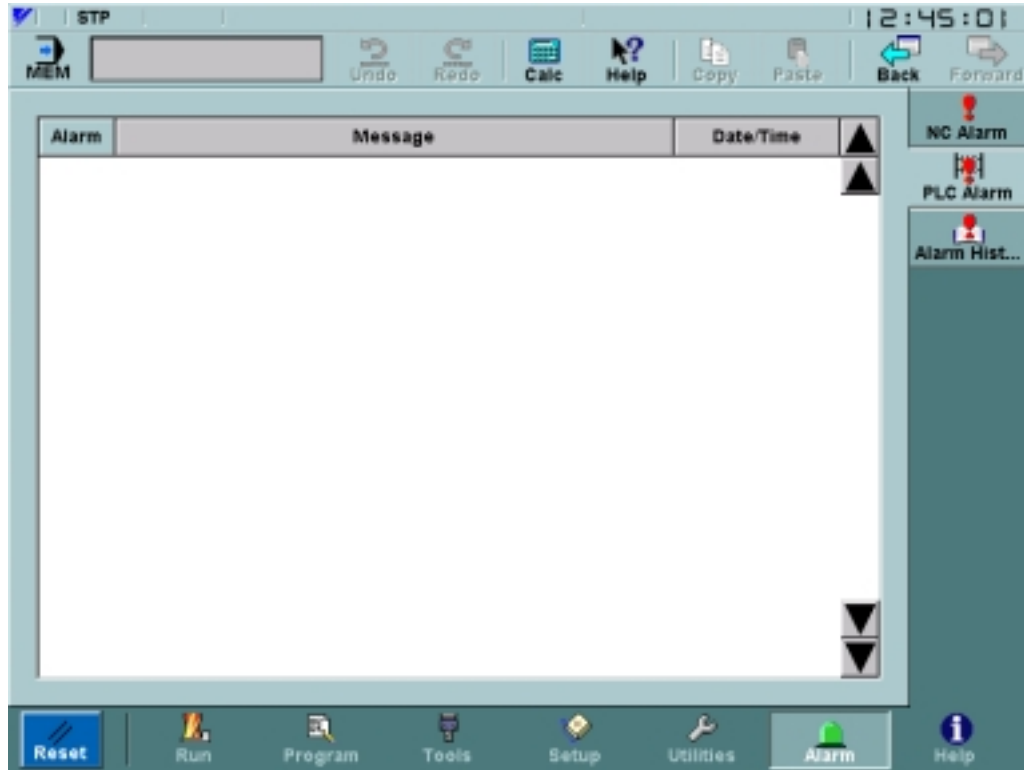

FIGURE 3.8.2.1. The PLC Alarm Screen

The *Alarm:PLC Alarm* screen, shown in Figure 3.8.2.1 on page 97, displays errors from the PLC.

3.8.3 Alarm History Screen

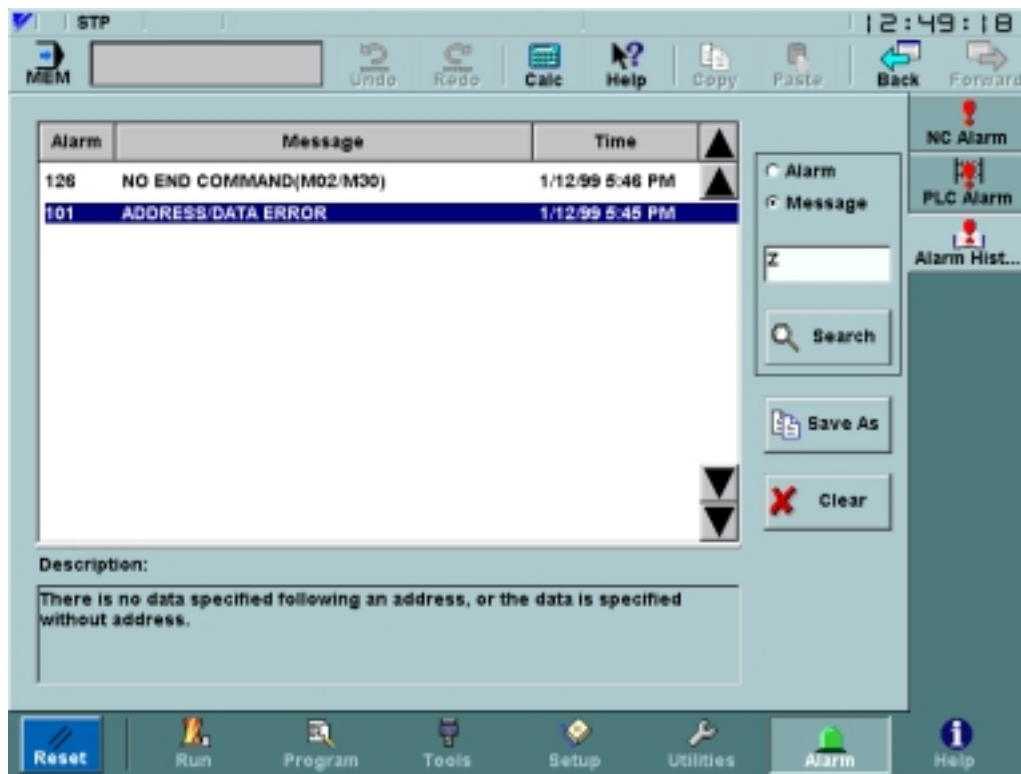

FIGURE 3.8.3.1. The Alarm History Screen

The *Alarm History* screen, shown in Figure 65, displays alarm number, message, and time the alarm was signalled. Touching an alarm in the table causes additional information to be displayed in the **Description** area below the table. The history starts from when the NC was started or the last time the **Clear** button was pressed, whichever is most recent.

It is possible to search the alarm history for a string. The toggle in the upper right corner specifies whether the **Alarm** or **Message** field should be used for the search. The string to search for is entered below the toggle, and the search commences when the **Search** button is pressed. “String not found” is displayed in the warning area if the search produces no matches.

The **Save As** button pops the dialog shown in Figure 3.8.3.2 on page 99. This dialog is used to specify a file and directory to which the alarm history data shown will be written. A new alarm history file can be created by selecting a directory and typing in the **Filename** field. A file may also be selected directly, at which point its name will be displayed in the **Filename** field. The dialog behavior is similar to a file browser, discussed in “File Browser” on page 23.

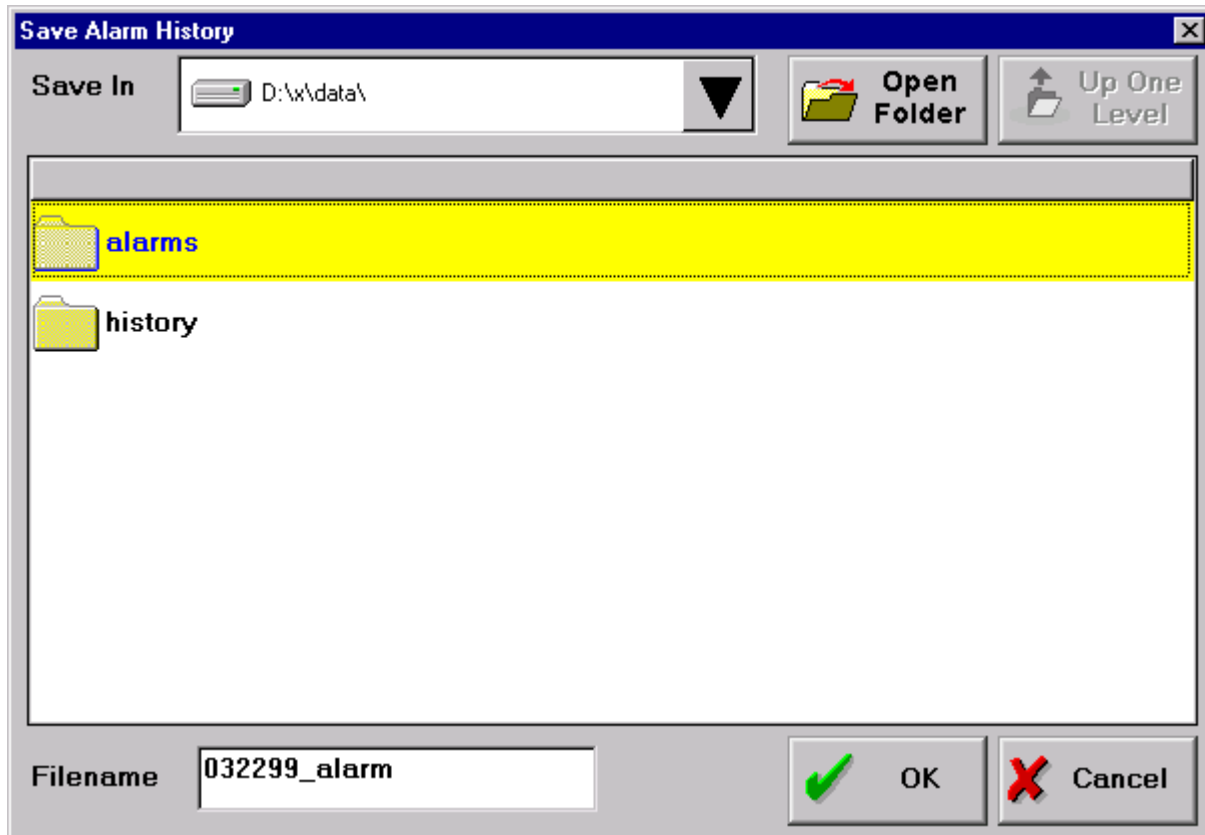

FIGURE 3.8.3.2. The Save Alarm History Dialog

3.9 HELP MENU

3.9.1 MMI Map Screen

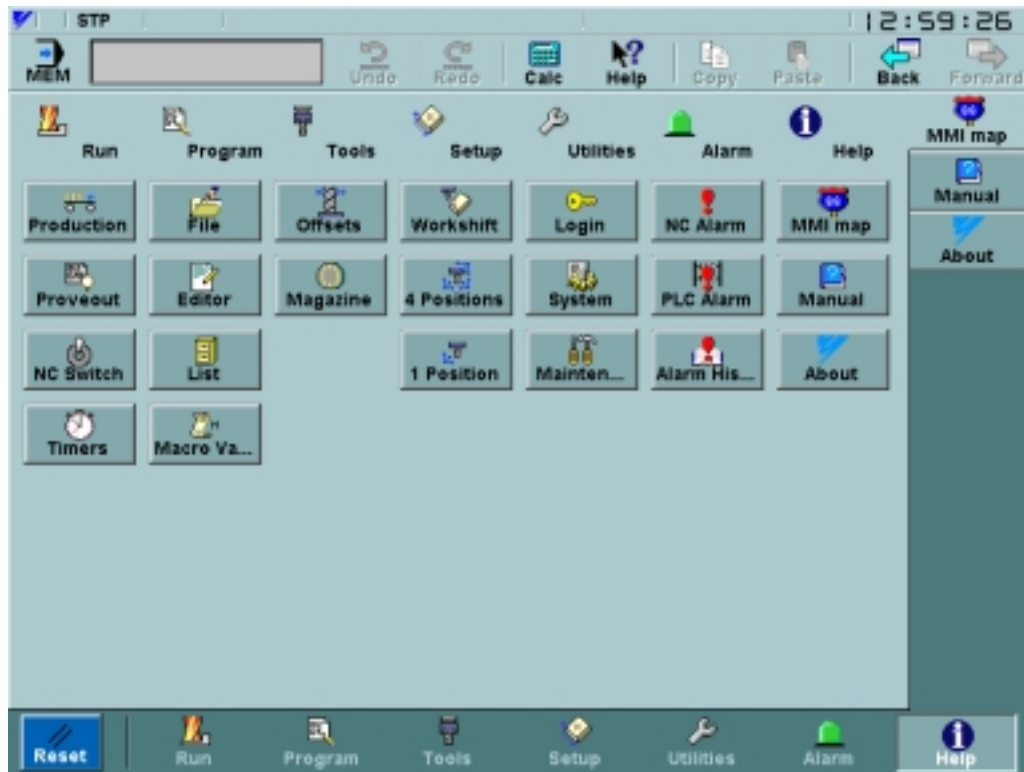

FIGURE 3.9.1.1. The MMI Map Screen

Clicking on one of the buttons in the *Help:MMI Map* screen will cause the interface to jump to the associated screen.

3.9.2 Manual Screen

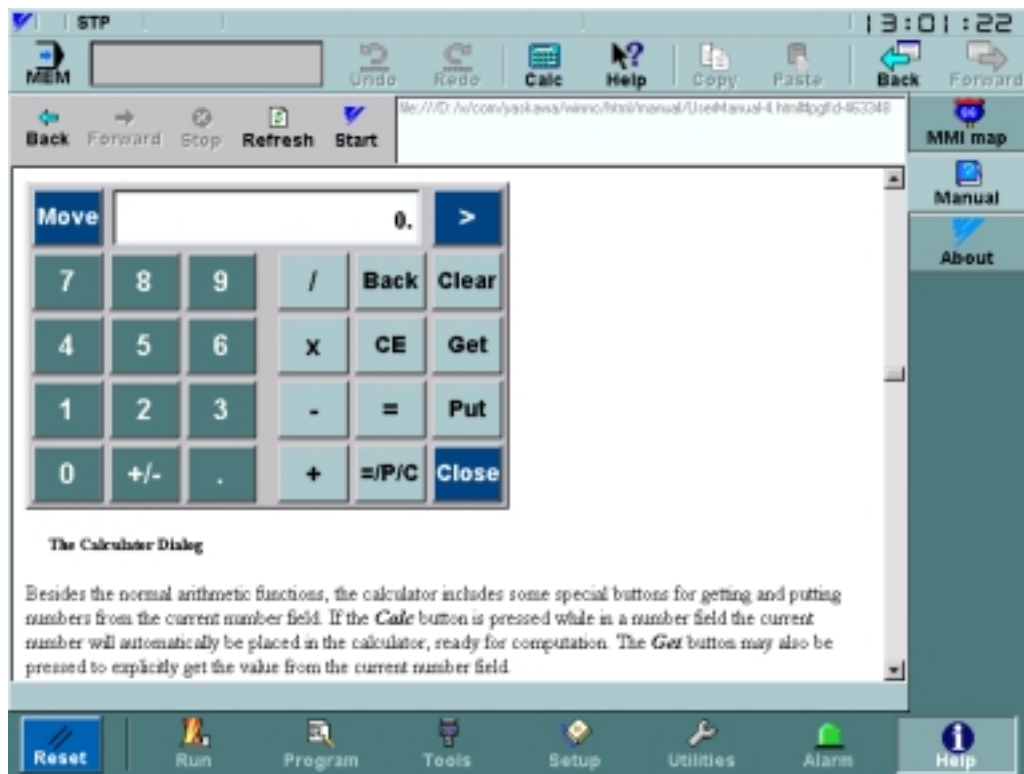







FIGURE 3.9.2.1. The Help Manual Screen

-  The **Back** arrow is used to jump to the last page shown on the *Manual* screen. It is disabled if there is no previous page.
-  The **Forward** arrow will go to the page that is the next in the page list. This is disabled if the back arrow has never been used.
-  The **Stop** button is used to stop a page from loading.
-  The **Reload** button is used to re-read the page from a file.
-  The **Home** button returns to the starting page for the *Help:Manual* screen.

3.9.3 About Screen

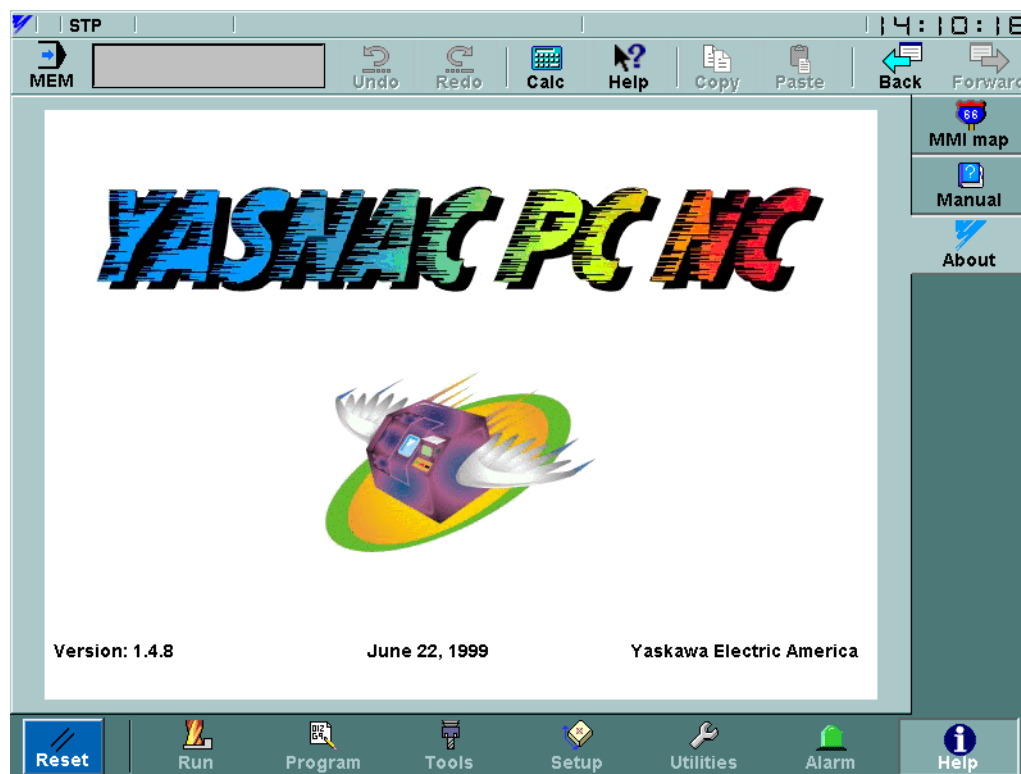

FIGURE 3.9.3.1. The About Screen

The *Help:About* screen shows version and release date information for the installed PCNC software.

3.10 OFF LINE MODE

When the system switch is set to E, the system is in offline mode, and the offline mode screen, shown in Figure 3.10.1.1 on page 103, is shown in lieu of the usual MMI. In addition to changing display properties, this screen permits CMOS initialization and MMI software updates.

3.10.1 The Offline Mode Interface



FIGURE 3.10.1.1. The Offline Mode Screen

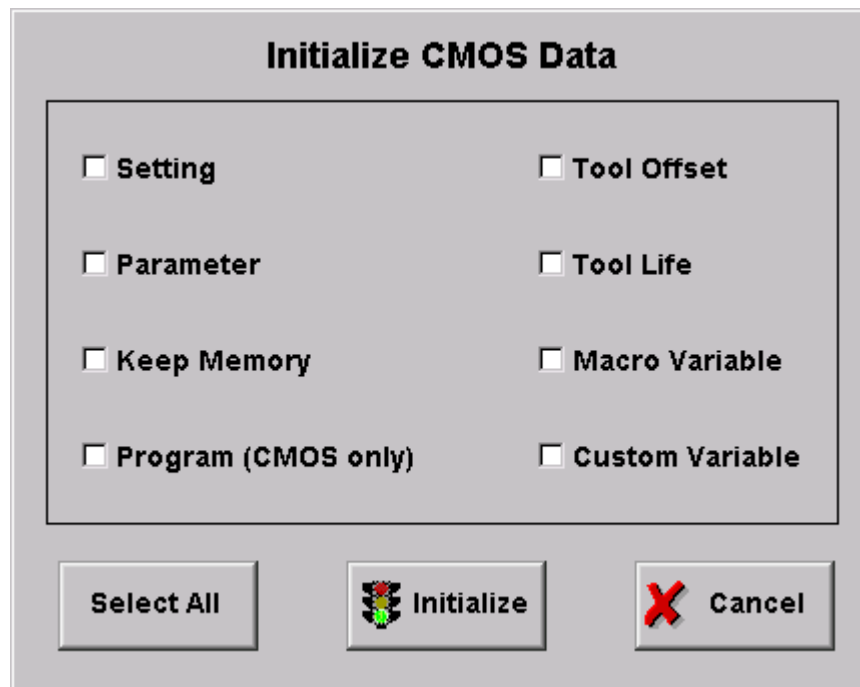

FIGURE 3.10.1.2. The Initialize CMOS Data Screen

The *Initialize CMOS Data* dialog is shown in Figure 3.10.1.2 on page 104. A dialog will appear after **Initialize** is pressed to confirm that initialization should occur.

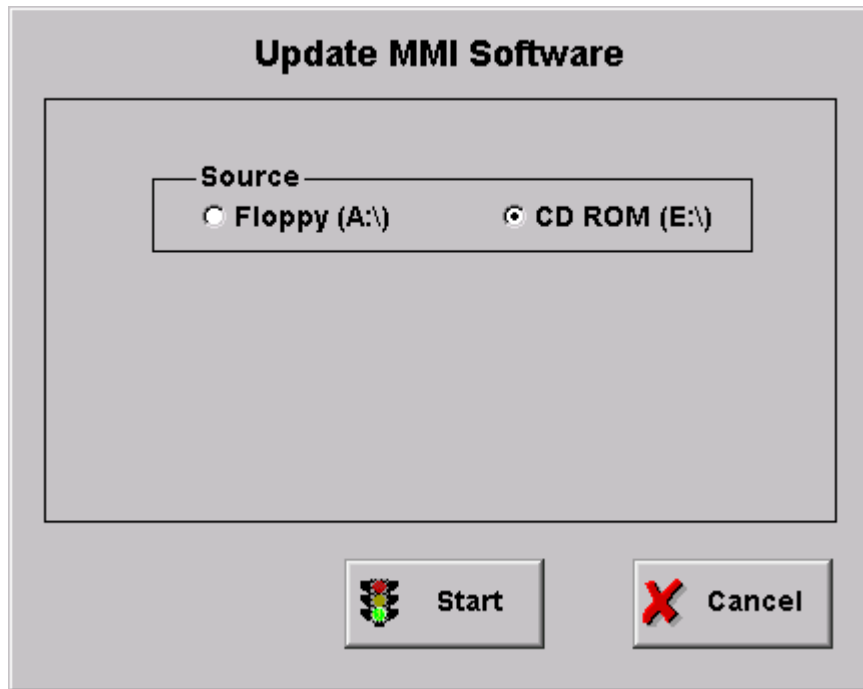

FIGURE 3.10.1.3. The Update MMI Software Screen

4

Maintenance

Chapter 4 describes the maintenance data that can be accessed by the users.

4.1	MAINTENANCE DATA	4-2
4.1.1	Checking the Status of Problems	4-2
4.1.2	Checking the NC Information.....	4-3
4.1.3	Display of Alarm Information.....	4-3
4.1.4	Cause of Alarm and Corrective Action.....	4-4
4.1.5	Troubleshooting (1).....	4-5
4.1.6	Troubleshooting (2).....	4-12
4.1.7	Alarms Not Indicated by Alarm Numbers	4-16
4.1.8	PCNC Alarms Not Indicated by Alarm Numbers.....	4-28
4.1.9	Touch Screen Maintenance	4-28
4.1.10	Mode of PCNC Operation.....	4-29
4.1.11	Self-Diagnosis Function	4-30
4.1.12	Hard Drive Mounting Replacement	4-32

4.1 MAINTENANCE DATA

To locate the cause of problems or when contacting your Yaskawa representative for advice, it is very important that users precisely understand the actual situation. To minimize the downtime, check the following points carefully.

CAUTION!

- When an alarm occurs, eliminate the fault and assure operation safety before resetting it.
Failure to observe this caution could result in equipment malfunction.
- For details on trouble relating to the machine-related sequence, refer to the machine tool manual.

4.1.1 Checking the Status of Problems

(1) Understanding the Situation

To identify the nature of the problem, first check the following items.

- Type of operation that causes a problem.
Do other types of operations not cause problems?
- Q Details of problems.
How, frequency (always or sometimes), and when?
- Unusual situation when the problem occurred.
- Was there an unusual external occurrence (such as power failure or lightning) when the problem occurred?
- Timing of problem occurrence.
Had the problem occurred during or after the operation of the keys or in a specific operation mode?

(2) Check Items

(a) Problems related with axis feed and spindle drive

Check the following items.

- Indication status of the LEDs on the drive unit
- Fuses and breakers
- Timing of problem occurrence – when the power is turned ON, during acceleration, during deceleration or during fixed speed spindle rotation, etc.?

(b) Problems related to part program

Record the program block data, offset data, workpiece coordinate system offset data, coordinate system setting data, etc.

4.1.2 Checking the NC Information

Aside from the specific problem, the following information must be obtained.

(1) Hardware Environment

- Machine tool builder's name
- Delivery date of machine tool
- Type and model name of the machine tool
- Type and model name of the NC and units

(Example)

NC unit	YASNAC PCNC
Servo drive	SGDC-AJA
Servo motor	SGMG
Spindle drive	CIMR-M5N20155
Spindle motor	UAASKD-11HB11

4.1.3 Display of Alarm Information

If an alarm occurs, the alarm number and comment of the alarm of the top priority is displayed in the normal display area disregarding the selected mode and the screen. For the procedure to display the alarm information, refer to 7.2, "ALARM DISPLAY JOB".

4.1.4 Cause of Alarm and Corrective Action

The following shows the listing of YASNAC PCNC alarms.

Table 4.1.4.1: Alarm Numbers and Classification

NUMBER	CONTENTS	STOP MODE	OUTPUT	HOW TO RESET
0000 to 0049	Errors related to edit and operation Occurring in the background mode also.	Block stop	Input error alarm	Reset
0050 to 0099	Errors related to edit and operation Not occurring in the background mode.	Block stop	Input error alarm	Reset Power OFF for #0050 and #0051
0100 to 0499	Program error	Block stop	Input error alarm	Reset
1000 to 1099	Program error DNC, COMS total, etc.	Block stop	Input error alarm	Reset
2000 to 2199	Machine related error OT, reference point return, machine ready, in-position, etc.	Stop after deceleration, or immediate stop	Alarm	Reset operation after removing the cause. With the alarm caused by the machine ready signal, if it occurs in the first power ON operation, it is automatically reset.
3000 to 3299	Servo and spindle related alarm ESP, CPU mutual monitoring	Immediate stop, or serve, OFF	Alarm	Reset after removing the cause. With the SVOFF alarm, it is automatically reset by the SVON.
8000 to 8049	Memory check error Watchdog timer error Off-line error	Immediate stop, or serve OFF	Alarm	For maintenance CPU halt Switching to the special maintenance screen
9000 to 9049	Error occurring in background editing (basically the same as with 0000 to 0049)	Not stopped	Background error output	Reset or with reset soft-key
No number indication BAT indication BAT, AXIS	Battery error Encoder alarm	Not stopped	No output	Changing the battery
No number indication Warning message	Key operation error, edit operation error (not serious operation error)	Not stopped	Warning	Next key operation

4.1.5 Troubleshooting (1)

(1) Alarm No.: 1099 (High Temperature)

Table 4.1.5.1: Countermeasures - Alarm N.: 1099 (High Temperature)

CAUSE	CHECK ITEM	COUNTERMEASURES
<p>Ambient temperature of the NC rack exceeded the specified value* due to the failure of cooling fan.</p> <p>*: 70°C ± 3°C when measured above CPS-18.</p>	<ul style="list-style-type: none"> • Open the NC unit door to check if the cooling fan is operating correctly. • Make sure that air is blowing out through the ventilation port of the cooling duct. • Make sure that the ventilation port of the cooling duct is not blocked. 	<ul style="list-style-type: none"> • If the fan is faulty, it is necessary to change it. Contact your Yaskawa representative. • If the cooling duct is blocked remove interfering object and start the cooling fan.
<p>Internal temperature of the power supply unit is high.</p>	<p>Allow the power supply unit to cool by turning OFF the power with PCNC unit door opened. If the alarm occurs even after the power supply unit has been cooled for 30 minutes, the power supply unit will be faulty.</p>	<p>It is necessary to change the power supply unit. Contact your Yaskawa representative.</p>
<p>Ambient temperature of the 1 NC unit is high.*</p> <p>*:Allowable temperature range for operation is 0 to 40°C.</p>	<ul style="list-style-type: none"> • Measure ambient temperature. • If the NC unit is subject to direct sunlight, the NC unit temperature will exceed the allowable limit. 	<ul style="list-style-type: none"> • This is not the failure of the NC unit. Remove the cause.

(2) Alarm Nos.: 2061 to 2068 (Reference Point Return Area Error)

Table 4.1.5.2: Troubleshooting - Alarm Nos.: 2061 to 2068 (Reference Point Return Area Error)

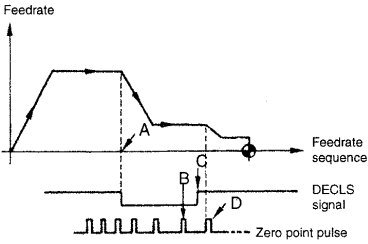
CAUSE	CHECK ITEM	COUNTERMEASURES
<p>The reference point return start point is at the zero point side of the deceleration limit switch.</p>	<p>Deceleration limit switch (DECLS)</p> <p>#3073 DO (1st axis) Execute reference point return again while observing the I/O signal monitor screen</p> <p>#3073 D1 (2nd. axis)</p> <p>#3073 D2 (3rd axis)</p> <p>#3073 D3 (4th axis)</p> <p>#3073 D4 (5th axis)</p> <p>If reference point return is started from a point located at the reference point side of DECL (point C) as shown below, an alarm occurs.</p> <p>Note: This error check is not made before the execution of manual reference point return after the power is turned ON.</p> 	<p>Return the axis to a position on the deceleration LS or away from it and, then, execute reference point return once again.</p>
<p>Approach feedrate is too fast.</p>	<p>Compare the setting for the approach feedrate parameter with the parameter list.</p>	<p>Change the setting for parameters pm2521 to pm2525 to an appropriate value.</p>

(3) Alarm Nos.: 2071 to 2078, 2081 to 2088 (Reference Point Return Position Error)

Table 4.1.5.3: Troubleshooting – Alarm Nos.: 2071 to 2078, 2081 to 2088 (Reference Point Return Position Error)

CAUSE	CHECK ITEM	COUNTERMEASURES
<p>Alarm in manual reference point return operation</p>	<p>Check if the error occurs every time.</p>	<p>Contact machine tool builder or your Yaskawa representative.</p>
<p>Alarm in automatic reference point return operation</p>	<p>G28: Check if the alarm occurs every time.</p>	<p>Contact machine tool builder or your Yaskawa representative.</p>
	<p>G27: Check the point specified in the program if it agrees with the zero point.</p>	<p>Review the program.</p>

(4) Alarm Nos.: 2101 to 2108 (P-SET Error)

The P-SET alarm occurs if the error between the position specified in the program and the actual machine position is larger than the value set for parameterspm1321 (1st axis) to pm 1325 (5th axis) in the following modes of operation.

At the completion of positioning in G00, G27, G28, G29, G30, etc., error detect ON (1/O monitor parameter #3004 D4 = 1), and G04 (dwell).

If error pulses have been accumulated, check the number of accumulated pulses on the Error Pulse Display Screen before contacting your Yaskawa representative.

(5) Alarm No.: 3000 (Servo Power Not Ready)

Table 4.1.5.4: Troubleshooting - Alarm No.: 3000 (Servo Power Not Ready)

CAUSE	CHECK ITEM	COUNTERMEASURES
Secondary power supply is not applied	If the NC RESET switch, etc. is depressed after depressing the POWER ON button once, or after clearing the emergency stop or alarm state, the alarm message is displayed. This does not indicate the occurrence of alarm.	Press POWER ON button again.
With the secondary power ON, I/O input specification the input is not turned ON. (For the automatic servo power ON)	Check the following on the I/O monitor screen: #3005 DO = 1 (SVON) #3503 DO = 1 (SVONS)	Contact your Yaskawa representative.
Emergency stop signal stays ON.	Check if alarm No. 3002 is displayed (#3503 D4 = 1) on the screen.	Reset the emergency stop input signal.
The secondary power ON signal is turned OFF due to some other alarm.	Check the alarm indication for other alarms.	Take appropriate measures by referring to the alarm code.

(6) Alarm No.: 3001 (Control Not Ready)

The PCNC executes self-diagnosis after power ON. If positioning error checked during this self-diagnosis exceeds the values set for parameters pm 1321 (1st axis) to pm1325 (5th axis), this alarm occurs.

Table 4.1.5.5: Troubleshooting - Alarm No.: 3001 (Control Not Ready)

CAUSE	CHECK ITEM	COUNTERMEASURES
Machine (axes) have moved.	Select the error pulse display screen from the present position display screen in the common process and check the error pulse value.	Contact machine tool builder or your Yaskawa representative.
PG signal remains output.		PG or AC servo must be changed. Contact your Yaskawa Presentative.

(7) Alarm Nos.: 3041 to 3048 (Excessive Follow-up Error)

If the follow-up error between the command values and the actual position values exceeds 120% of the error in rapid traverse (100%) operation, this alarm occurs. Check the values set the for parameters pm1671 to pm1675, pm1681 to pm1685 and contact the machine tool builder or your Yaskawa representative.

(8) Alarm No.: 3051 (Excessive Follow-up Error: Spindle)

If the follow-up error between the command values and the actual position values exceeds the value set for parameter pm1351, this alarm occurs. Check the values set the for parameters pm1351 and contact the machine tool builder or your Yaskawa representative.

(9) Alarm Nos.: 3061 to 3068 (Overload)

Table 4.1.5.6: Troubleshooting - Alarm Nos.: 3061 to 3068 (Overload)

CAUSE	CHECK ITEM	COUNTERMEASURES
Cutting conditions	Check if the alarm has occurred during machining.	Turn OFF the power and allow the servomotors to cool. After that, change the machining conditions to lighter conditions and restart the operation.
Guideways are not lubricated properly causing heavy axis movements.	Check the guideways if they are lubricated properly.	Contact the machine tool builder.

Note: In other cases, contact your Yaskawa representative.

(10) Alarm Nos.: 3081 to 3088 (Broken PG Cable)

The A and B phase signal cables are checked for breakage.

Table 4.1.5.7: Troubleshooting – Alarm Nos.: 3081 to 3088 (Broken PG Cable)

CAUSE	CHECK ITEM	COUNTERMEASURES
Signal cables between the NC and the AC servo drive unit are broken or loose.	Make sure that the cable connectors are plugged into the connectors securely.	If they are loose or disconnected, re-connect them correctly.
Faulty PG cable breakage detection circuit.	Check if the alarm occurs in the first pressing of POWER ON button even if the cables are connected correctly.	Contact your Yaskawa representative.
Error in motor type parameter setting	Check the motor type setting parameters (pm 1061 to pm 1065) if "0" has been set.	Correct the setting for the motor type setting parameters (pm1061 to pm1065).

(11) Alarm No. 3091 (Broken Spindle PG Cable)

The A, B, and C phase signal cables are checked for breakage.

Table 4.1.5.8: Troubleshooting – Alarm No.: 3091 (Broken Spindle PG Cable)

CAUSE	CHECK ITEM	COUNTERMEASURES
Signal cables between the NC and the AC servo drive unit are broken or loose.	Make sure that the cable connectors are plugged into the connectors securely.	If they are loose or disconnected, re-connect them correctly.
Faulty PG cable breakage - detection circuit	Check if the alarm occurs in the first pressing of POWER ON button even if the cables are connected correctly.	Contact your Yaskawa representative.
Faulty PG	If an alarm occurs during low speed operation, the PG could be faulty.	Contact your Yaskawa representative.

(12) Alarm Nos.: 3121 to 3125 (Excessive Speed)

This alarm is detected if the motor speed exceeds 1.2 times the maximum motor speed.

Contact your Yaskawa representative.

(13) Alarm Nos.: 3161 to 3165 (Absolute Error)

Malfunction of the absolute encoder is detected. Contact your Yaskawa representative after checking the following:

- Whether the alarm occurs immediately after the control power is turned ON.
- Whether the alarm is cleared when the power is turned OFF and then turned ON again.
- Whether the battery alarm occurs at the same time.

(14) Alarm Nos.: 3181 to 3185 (Position Error)

Malfunction of the PG pulse (counter in the absolute encoder) is detected. Contact your Yaskawa representative after checking the following:

- Whether the alarm occurs immediately after the control power is turned ON.
- Whether the alarm occurs frequently during operation.

(15) Alarm Nos.: 3201 to 3205 (Servo Drive Unit Communication Error)

Communication error between the NC and the AC servo drive unit is detected. Contact your Yaskawa representative.

(16) Alarm Nos.: 3301 to 3305 (Over current)

Contact your Yaskawa representative after checking the following:

- Whether the alarm occurs immediately after the control power is turned ON.
- Whether the alarm occurs after turning ON the main power.

(17) Alarm No.: 3311 to 3315 (MCCB Trip)

Contact your Yaskawa representative after checking the following:

- Whether the alarm occurs immediately after the control power is turned ON.
- Whether the alarm occurs after turning ON the main power.

(18)Alarm No.: 3321 to 3325 (Regeneration Error)

Contact your Yaskawa representative after checking the following:

- Whether the alarm occurs immediately after the control power is turned ON.
- Whether the alarm occurs after turning ON the main power.

(19)Alarm No.: 3331 to 3335 (Over Voltage)

Contact your Yaskawa representative after checking the following:

- Whether the alarm occurs at the start of motor rotation.
- Whether the alarm occurs during deceleration.

(20)Alarm No.: 3341 to 3345 (Under Voltage)

Contact your Yaskawa representative after checking the following:

- Whether the alarm occurs after turning ON the main power.

(21)Alarm No.: 3351 to 3355 (Heat Sink Overheat)

Table 4.1.5.9: Troubleshooting - Alarm No.: 3351 to 3355 (Heat Sink Overheat)

CAUSE	CHECK ITEM	COUNTERMEASURES
Faulty control board	Check whether the alarm occurs immediately after the control power is turned ON.	Contact your Yaskawa representative.
Fan stop	<ul style="list-style-type: none"> • Check whether the alarm occurs during operation (alarm reoccurs if the control power is turned ON after turning it OFF once, or the operation restarts when the NC is reset after several minutes.) • Check whether the fan is rotating. 	Contact your Yaskawa representative.

(22)Alarm No.: 3361 to 3365 (Wire Break in Current Instruction Cable)

Contact your Yaskawa representative after checking the following:

- Whether the alarm occurs immediately after the control power is turned ON.
- Whether an alarm other than current instruction cable breakage alarm occurs.(23)
Alarm No.: 3371 to 3375 (Open Phase Detection)

Contact your Yaskawa representative after checking the following:

- Whether the alarm occurs immediately after the control power is turned ON.
- Whether the alarm occurs after turning ON the main power.

4.1.6 Troubleshooting (2)

For the system equipped with a drive unit compatible with YENET1 200, check is made by both the drive unit itself and the PCNC unit. If a fault is detected, the drive unit notifies the PCNC unit of the alarm information in both systems.

The drive unit first gives the PCNC unit the information on the occurrence of an alarm (alarm No. 3101 to No. 3105 and No. 3201) and then the content of the alarm. The NC unit displays alarm No. 3100 when it receives the alarm information from drive units.

Therefore, three alarms usually occur if an error is detected with the drive unit. If a fuse blown occurs with the X-axis servo unit, alarm No. 3100, No. 3101, and No. 3021 occur.

(1) Alarm Nos.: 3021 to 3025 (Fuse Blown)

The main circuit of the servo unit will be faulty.

The servo unit detects the error.

Contact your Yaskawa representative.

(2) Alarm Nos.: 3041 to 3045, 3051 (Excessive Follow-up Error)

This alarm occurs if the follow-up error exceeds 120% of the error in rapid traverse (100%) operation.

The servo unit detects the alarm.

Improper gain adjustment is one of the reasons.

Contact your Yaskawa representative.

(3) Alarm Nos.: 3061 to 3065 (Overload)

This alarm occurs if the load exceeds the rated torque considerably.

The servo unit detects the error.

Review the cutting conditions. Contact your Yaskawa representative after checking whether the alarm occurred simply after turning the control power ON.

(4) Alarm Nos.: 3081 to 3085 and 3091 (Broken PG Cable)

The encoder signal cable or the encoder itself will be faulty.

The servo unit or the inverter detects the error.

Contact your Yaskawa representative.

(5) Alarm Nos.: 3101 to 31051 (Servo Alarm)

This alarm occurs when the NC unit detects the alarm signal output from the servo unit.

Check the contents of the alarm by displaying the servo alarm display screen (press [F2] of the alarm job in the common process.).

(6) Alarm Nos: 3111 to3115 (Servo Communication Alarm)

Probable causes of this alarm are a broken YENET1 200 communication cable, loose cable connection and communication processing error.

The servo unit detects the alarm.

Contact your Yaskawa representative after making sure that the cable is securely connected.

(7) Alarm Nos.: 3121 to 3125 (Excessive Speed)

This alarm occurs if the motor speed exceeds 4950 r/rein or the value set for the parameter.

The servo unit detects the alarm.

It is necessary to check whether the connection to the encoder is correct.

Contact your Yaskawa representative.

(8) Alarm Nos.: 3141 to 3145 (Overrun, Run-away Prevention)

The encoder will be faulty.

The servo unit detects the alarm.

Contact your Yaskawa representative.

(9) Alarm Nos.: 3151 to 3155 (Phase Detection Error)

The encoder signal cable or the encoder itself will be faulty.

The servo unit detects the error.

Contact your Yaskawa representative.

(10)Alarm Nos.: 3161 to3165 (Absolute Error)

This alarm occurs if the absolute value data cannot be received correctly in one to two seconds after turning ON the power to the encoder.

The servo unit detects the error.

The encoder or the servo unit will be faulty.

Contact your Yaskawa representative.

(11) Alarm Nos.: 3181 to 3185 (Absolute Position Error)

The number of feedback pulses is checked every turn of the encoder, and this alarm occurs if there is an error in the number of pulses counted.

The servo unit detects the alarm.

The encoder or the servo unit will be faulty, or malfunction could have occurred due to noises.

Contact your Yaskawa representative.

(12) Alarm No.: 3201 (Inverter Alarm)

This alarm occurs when the NC unit detects the alarm signal output from the inverter.

Check the contents of the alarm by displaying the servo alarm display screen (press [F2] of the alarm job in the common process.).

(13) Alarm Nos.: 3281 to 3285, 3291 (YENET1 200 command time-out)

This alarm occurs when the YENET1200 communication lines fail to get ready.

The NC units detects the alarm.

The servo unit or the inverter unit is faulty.

Contact your Yaskawa representative.

(14) Alarm Nos.: 3301 to 3305 (Over Current)

The servo unit detects the alarm.

The servo unit will be faulty if the alarm occurs before the operation is started after turning the power ON,

If the alarm occurs during operation, ground fault of the motor is the cause.

Contact your Yaskawa representative.

(15) Alarm Nos.: 3331 to 3335 (Over Voltage)

The servo unit detects the alarm.

If the alarm occurs when the power is turned ON to the spindle, the input voltage will be too high.

If the alarm occurs during motor operation, it is necessary to review the operation conditions, e.g., lower motor speed.

If the alarm occurs when the servo control power is turned ON, the servo unit will be faulty.

Contact your Yaskawa representative.

(16) Alarm Nos.: 3351 to 3355 (Heat Sink Overheat)

This alarm occurs when the heat sink temperature is abnormally high.

The servo unit detects the alarm.

If this alarm occurs, turn OFF the power and allow the heat sink to cool. After that, turn the power ON again.

If the alarm occurs immediately after turning the power ON, the servo unit is faulty.

Contact your Yaskawa representative.

(17) Alarm Nos.: 3381 to 3385, 3391 (YENET1200 Communication Error)

This is an communication error between the NC unit and the servo unit or between the NC unit and the inverter unit; the NC unit detects the alarm when no answer is returned for the command output by the NC unit.

The servo unit or the inverter unit will be faulty, or the cable will not be connected securely.

Contact your Yaskawa representative.

(18) Alarm Nos.: 3401 to 3405 (Converter Alarm)

This alarm occurs due to the following reasons: blown fuse, regeneration alarm, open phase, or faulty board.

The servo unit detects the alarm.

Contact your Yaskawa representative.

(19) Alarm Nos.: 3411 to 3415 (Servo Unit Alarm)

This alarm occurs due to the following reasons: destroyed parameter setting, faulty current detector, encoder's battery alarm, memory error or sensor error.

The servo unit detects the alarm.

The servo unit or the motor is faulty.

Contact your Yaskawa representative.

(20) Alarm No.: 3421 (Inverter Unit Alarm)

This alarm occurs when the inverter detects an alarm other than converter alarm, broken PG cable, excessive follow-up error and communication error.

Contact your Yaskawa representative.

(21) Alarm Nos.: 3425, 3431 to 3435 (YENET1 200 Watchdog Error)

This alarm occurs when the NC unit detects the watchdog error with the inverter unit or the servo unit.

The inverter unit or the servo unit will be faulty.

Contact your Yaskawa representative.

(22) Alarm Nos.: 3441 to 3445 (Ground Fault)

This alarm occurs when the servo unit detects the alarm when the power is turned ON.

Motor insulation is faulty.

Contact your Yaskawa representative.

(23) Alarm No.: 3451 and 3452 (Follow-up Error)

This alarm occurs when the follow-up error exceeds the value set for the servo unit parameter.

The servo unit detects the alarm.

If this alarm occurs during axis feed over a long distance, it is necessary to either lower the command speed or increase the gain.

If the motor does not rotate, the servo unit will be faulty.

Contact your Yaskawa representative.

4.1.7 Alarms Not Indicated by Alarm Numbers

(1) No Display is Given on the CRT

If nothing is displayed on the CRT, the CRT itself might be faulty or the display circuit or connection cables might be faulty. When nothing is displayed even if the power can be turned ON to the PCNC, check the cable connection to the operation panel and also the connectors.

(2) Handle Mode Operation is Impossible

(a) Handle mode signal is not input

- Check the bit status of UO monitor #3000.
D₂ = 1
Other bits (D₀, D₁, D₃ to D₇) = 0
- Check the mode display given in the normal display area on the screen.

(b) Axis selection signal is not input

- I/O monitor
Check whether one of the following bits is ON.

#3070	
D ₀ = 1	1st axis
D ₁ = 1	2nd axis
D ₂ = 1	3rd axis
D ₃ = 1	4th axis
D ₄ = 1	5th axis

- No. 2 handle

Check whether one of the following bits is ON.

#3080	
D ₀ = 1	1st axis
D ₁ = 1	2nd axis
D ₂ = 1	3rd axis
D ₃ = 1	4th axis
D ₄ = 1	5th axis

- No. 3 handle

Check whether one of the following bits is ON.

#3081	
D ₀ = 1	1st axis
D ₁ = 1	2nd axis
D ₂ = 1	3rd axis
D ₃ = 1	4th axis
D ₄ = 1	5th axis

(c) There is no input to handle PG

- Check the input voltage (5V) at the handle PG terminal.
- Check the handle PG signal cable connector to see if it is securely plugged in.

(d) Handle PG is faulty

Check the following (counter monitor) on the I/O screen if the values change according to the operation of the pulse handle.

#3037 (No. 1 handle)

#3038 (No. 2 handle)

#3039 (No. 3 handle)

(e) Other related parameters

Check the setting for the following parameters.

Maximum feedrate for handle operation	Parameter pm2860 (linear axis) Parameter pm2861 (rotary axis)
Acceleration/deceleration time constant	Parameters pm2561 to pm2565
Pulse multiplication ratio of “×100” is set (pm2003 D7 = 1)	Parameter pm2549

(3) Jog Operation is Impossible

(a) Jog mode signal is not input

Check the bit status of I/O monitor #3000.

D1 = 1

Other bits (D0, D2 to D7) = 0

(b) Axis move direction signal is not input.

Check the bit status of I/O monitor #3071 and #3072.

#3071		#3072	
D0	+1st axis	D0	-1st axis
D1	+2nd axis	D1	-2nd axis
D2	+3rd axis	D2	-3rd axis
D3	+4th axis	D3	-4th axis
D4	+5th axis	D4	-5th axis

(c) Jog feedrate signal is not input, or job feedrate setting parameter is incorrect

Check the bit status on the I/O monitor screen whether it changes according to the operation of the JOG FEEDRATE switch, and also check if the setting for the parameters is correct.

Table 4.1.7.1: Jog Feedrate

STEP	I/O MONITOR #3002					JOG FEEDRATE
	D4	D3	D2	D1	D0	
	JV16	JV8	JV4	JV2	JV 1	
1	0	0	0	0	0	Set for parameter pm2400
2	0	0	0	0	1	Set for parameter pm2401
3	0	0	0	1	0	Set for parameter pm2402
4	0	0	0	1	1	Set for parameter pm2403
5	0	0	1	0	0	Set for parameter pm2404
6	0	0	1	0	1	Set for parameter pm2405
7	0	0	1	1	0	Set for parameter pm2406
8	0	0	1	1	1	Set for parameter pm2407
9	0	1	0	0	0	Set for parameter pm2408
10	0	1	0	0	1	Set for parameter pm2409
11	0	1	0	1	0	Set for parameter pm2410
12	0	1	0	1	1	Set for parameter pm2411
13	0	1	1	0	0	Set for parameter pm2412
14	0	1	1	0	1	Set for parameter pm2413
15	0	1	1	1	0	Set for parameter pm2414
16	0	1	1	1	1	Set for parameter pm2415
17	1	0	0	0	0	Set for parameter pm2416
18	1	0	0	0	1	Set for parameter pm2417
19	1	0	0	1	0	Set for parameter pm2418
20	1	0	0	1	1	Set for parameter pm2419
21	1	0	1	0	0	Set for parameter pm2420
22	1	0	1	0	1	Set for parameter pm2421
23	1	0	1	1	0	Set for parameter pm2402
24	1	0	1	1	1	Set for parameter pm2423
25	1	1	0	0	0	Set for parameter pm2424
26	1	1	0	0	1	Set for parameter pm2425
27	1	1	0	1	0	Set for parameter pm2426
28	1	1	0	1	1	Set for parameter pm2427
29	1	1	1	0	0	Set for parameter pm2428
30	1	1	1	0	1	Set for parameter pm2429
31	1	1	1	1	0	Set for parameter pm2430
32	1	1	1	1	1	Set for parameter pm2431

(d) Axis interlock is input

Check the bit status on the I/O monitor screen. If “0”, the corresponding axis cannot move.

#3078	
D ₀ = 1	1st axis
D ₁ = 1	2nd axis
D ₂ = 1	3rd axis
D ₃ = 1	4th axis
D ₄ = 1	5th axis

(e) Machine lock is ON

- Even when the machine lock function is ON, position display changes. Check the input of the machine lock switch (I/O monitor, #3006 D5 = 0). If “1”, the axes do not move.
- Check the internal toggle switch (parameter pm0000 D 1 = 0). If “1”, the axes do not move.

(4) Manual Rapid Traverse is Impossible

(a) The rapid mode is not selected

Check the bit status of I/O monitor #3000.

DO = 1

Other bits (D1 to D7) = 0

(b) Axis move direction signal is not input.

Check the bit status of I/O monitor #3071 and #3072.

#3071		#3072	
D0	+1st axis	D0	-1st axis
D1	+2nd axis	D1	-2nd axis
D2	+3rd axis	D2	-3rd axis
D3	+4th axis	D3	-4th axis
D4	+5th axis	D4	-5th axis

(c) Rapid traverse override is not input

- Check tie bit status on the I/O monitor screen whether it changes according to the operation of the RAPID TRAVERSE RATE OVERRIDE switch, and also check

if the setting for the parameters is correct.

Table 4.1.7.2: Input Status and Rapid Traverse Rate

INPUT STATUS OF #3003		RAPID TRAVERSE RATE				
ROV2	ROV1	1st axis	2nd axis	3rd axis	4th axis	5th axis
1	1	Set for pm2801	Set for pm2802	Set for pm2803	Set for pm2804	Set for pm2805
1	0	[Set for pm2801] × 1/2	[Set for pm2802] × 1/2	[Set for pm2803] × 1/2	[Set for pm2804] × 1/2	[Set for pm2805] × 1/2
0	1	[Set for pm2801] × 1/4	[Set for pm2802] × 1/4	[Set for pm2803] × 1/4	[Set for pm2804] × 1/4	[Set for pm2805] × 1/4
0	0	F ₀ (set for pm2447)				

- For the 6-step specification (pm2000 D3 = 1) refer to Table 4.1.7.3.

Table 4.1.7.3: Input Status and Rapid Traverse Rate

INPUT STATUS			RAPID TRAVERSE RATE
ROV4	ROV2	ROV1	1st to 5th Axis I
1	0	1	F ₂ (set for prn2449)
1	0	0	F ₁ (set for pm2448)
0	1	1	100%
0	1	0	50%
0	0	1	23%
0	0	0	F ₀ (set for pm2447)

(d) Parameter setting is incorrect

Refer to Tables 4.18 and 4.19

(e) Axis interlock is input

Check the bit status on the I/O monitor screen. If “O”, the corresponding axis cannot move.

#3078	
D ₀ = 1	1st axis
D ₁ = 1	2nd axis
D ₂ = 1	3rd axis
D ₃ = 1	4th axis
D ₄ = 1	5th axis

(f) Machine lock is ON

- Even when the machine lock function is ON, position display changes. Check the input of the machine lock switch (I/O monitor, 3006 D5 = 0). If “1”, the axes do not move.
- Check the internal toggle switch (parameter pm0000 D1 = 0). If “1”, the axes do not move.

(5) Manual Reference Point Return is Incorrect

The following explanation is given assuming that jog and rapid traverse are executed correctly.

(a) Manual reference point return signal is not input

Check the I/O monitor #3007 D0. The status must be “1”.

Otherwise, the axis continues moving to OT at the same feedrate even if it reaches point A. Refer to Fig. 9.7.

(b) Jog or rapid traverse mode is not selected

I/O monitor #3000 D0 or D1 must be “1”.

- (c) Deceleration limit switch signal is not input.

Check I/O monitor #3073 DO to D4 while moving an axis at a slow feedrate such as in jog operation. Make sure feedrate changes as shown in Figure 4.1.7.1.

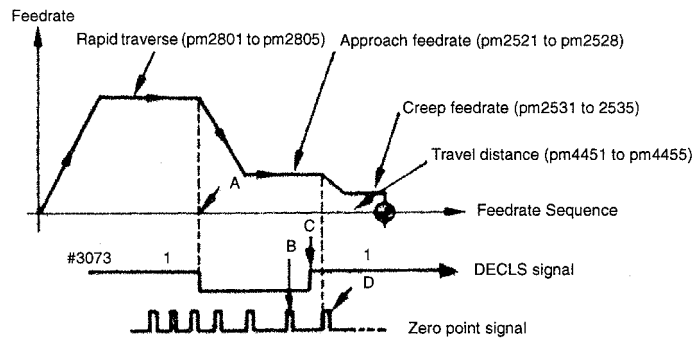

FIGURE 4.1.7.1: Reference Point Return Control I/O Signals

- (d) Parameter setting is incorrect.

Check the setting for the related parameters against the parameter sheet by referring to Fig. 4.1.7.1.

- (e) Position of the dog for the deceleration limit switch is incorrect.

If the dog position is incorrect, the zero point could be shifted by one turn of the motor.

- (f) Others (loose coupling or dog)

If another adjustment is incorrect, zero point could shift at random.

(6) Cycle Start is Impossible

- (a) Cycle start signal is not input or feed hold signal is open.

Check the I/O monitor #3003 D0 whether it goes “1” when the cycle start switch is pressed. In this case, the feed hold signal must be open; this can be confirmed by I/O monitor #3003 D1 = 1.

- (b) Start interlock signal is input.

If I/O monitor #3004 D2 = 1, cycle start is impossible.

- (c) The NC is in the reset status.

Normal status: I/O monitor #3500 D1 = 0

Also check the external reset signal status.

Normal status: I/O monitor #3004 D1 = 0

(7) G01, G02, or G03 Mode Operation is Impossible

- (a) The spindle is in the speed agreed status.

Check whether parameter pm 1000 D7 = 1.

If it is "1", check whether the spindle is in the speed agreed status by I/O monitor #3111.

(b) FEEDRATE OVERRIDE switch setting is 0%.

Check the setting for I/O monitor #311 1 D0 to D4 whether the setting is correct.

(c) In the dry run mode, setting for jog feedrate is incorrect.

Table 4.1.7.1: I/O Monitor and Feedrate Override

I/O MONITOR #3040					FEEDRATE OVERRIDE (AUTOMATIC OPERATION)
D4	D3	D2	D1	D0	
OV16	OV8	OV4	OV2	OV 1	
0	0	0	0	0	0%
0	0	0	0	1	10%
0	0	0	1	0	20%
0	0	0	1	1	30%
0	0	1	0	0	40%
0	0	1	0	1	50%
0	0	1	1	0	60%
0	0	1	1	1	70%
0	1	0	0	0	80%
0	1	0	0	1	90%
0	1	0	1	0	100%
0	1	0	1	1	110%
0	1	1	0	0	120%
0	1	1	0	1	130%
0	1	1	1	0	140%
0	1	1	1	1	150%
1	0	0	0	0	160%
1	0	0	0	1	170%
1	0	0	1	0	180%
1	0	0	1	1	190%
1	0	1	0	0	200%
1	0	1	0	1	220%
1	0	1	1	0	240%
1	0	1	1	1	260%
1	1	0	0	0	280%
1	1	0	0	1	300%
1	1	0	1	0	340%
1	1	0	1	1	380%
1	1	1	0	0	420%
1	1	1	0	1	460%
1	1	1	1	0	500%
1	1	1	1	1	540%

- (d) Start interlock signal is input.
 If I/O monitor #3004 D2 = 1, start interlock is ON.
 Normal: #3004 D2 = 0
- (e) Axis interlock is input.
 Check I/O monitor #3087 D0 to D4.
 Normal: #3078 D0 to D4 = 1
- (f) Setting of the servo system is incorrect.
 Check whether the axes can be moved manually.

(8) Spindle Rotation is Impossible

- (a) Error in a program (no S command or no spindle start M code)
 Check the contents of the program on the [RUN] screen.
- (b) Start signal has not been input.
 Check the output signals (#1100s) on the I/O monitor screen.
- (c) Spindle rotation command has not been output.
 Check #3654 to #3656 on the 110 monitor screen.
- (d) The spindle drive is in the alarm status.
 Check the alarm indication of the spindle drive.
- (e) Combination of GRO and SOR is incorrect, or “0” is input for parameter pm1412 or pm1413.
 Check I/O monitor #3110 by referring to Table 4.21.

Table 4.1.7.2: Input of GRO and SOR and S4-digit Command Analog Voltage

I/O Monitor #3110		S4-digit Command Analog Voltage
D7	D6	
GRO Input	SOR Input	
0	0	Voltage corresponding to the spindle speed specified in the NC program.
0	1	Voltage corresponding to parameter pm 1412
1	0	Voltage corresponding to parameter pm 1413
1	1	0V

Note: If “1” is set for parameter pm1000 D5, SSTP input is reversed.

(f) Setting for the parameters related to spindle operation is incorrect.

Check the setting for the related parameters.

#3110 D0	GR1
#3110 D1	GR2
#3110 D2	GR3
#3110 D3	GR4

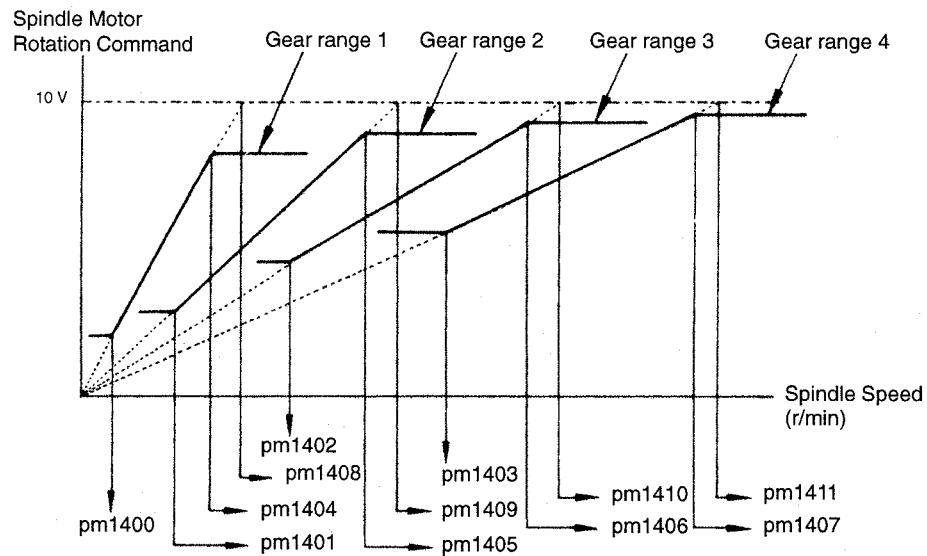

FIGURE 4.1.7.2: Spindle Rotation

(9) FIN Wait Status after Execution of Spindle Related Commands

If sequence processing is interrupted waiting for a signal, the NC enters the FIN wait status.

(a) Spindle speed agree signal is not input.

If the NC enters this status after the execution of such as “M03 S100” commands, check whether #311 1 D6 = 1 (waiting for FIN).

Check the I/O signals of #1000s at the I/O section by referring to the ladder chart supplied by the machine tool builder.

(b) Spindle zero speed signal is not input.

If the NC enters this status after the execution of “M05” command, check the I/O signals of #1000s at the I/O section by referring to the ladder chart supplied by the machine tool builder.

(c) Others

If the NC enters this status after the execution of “M19” or “M20” (spindle orientation command), check the I/O signals related with spindle orientation by referring to the ladder chart supplied by the machine tool builder.

(10)Edit Operation is Impossible

(a) The edit lock signal is input.

Check I/O monitor #3007 D2.

Normal: #3007 D2 = 0

If “#3007 D2 = 1”, program edit is impossible.

(b) Edit lock is set by the parameter (pm0000 D7).

Set “pm0000 D7 = 0” to cancel the edit lock setting.

(c) Others

The corresponding alarm message is displayed.

OVER MEM CAP !

TOO MANY PROGS !

ALREADY IN !

Delete unnecessary programs and edit the program again.

(11)Skip Function (G31) Failure

The skip signal has not been input.

- Check ON/OFF status of the skip signals by checking the I/O monitor #3514 D0 to D2.
- Check the operation of proximity switches, etc.

4.1.8 PCNC Alarms Not Indicated By Alarm Numbers

- (1) Fuse F1 blown on JZNC-JFC 10 card of CPU Rack.

When the 0.3 A F1 Fuse is blown on the JFC 10 card, “3002 Emergency stop” Alarm on CNC occurs.

In the diagnostic, when the # 3500 bit 2 * ESPS signal is ON, and the “3002 Emergency stop” alarm still occurs on the PCNC Status bar, check the 0.3 A F1 Fuse on the JFC 10 card.

- (2) Fuse F2 blown on JZNC-JFC 10 card of CPU Rack.

When the 5A F2 Fuse is blown on the JFC 10 card, “3001 Servo Alarm and 3002 Emergency stop” alarms occur. Check the LED D4, just above CN04 Connector of the JFC 10 card of CPU Rack. If this LED is not lit, then F2 Fuse has blown. Replace the fuse.

- (3) When the Servo ON and Shut Down button connections are not connected or are wrongly connected.

When the Servo ON and Shut Down buttons are not connected to the CN12 Connector, or are wrongly connected, “3002 Emergency stop and 3001 Servo alarms” is displayed on the PCNC. Check that the Servo ON and Shut Down buttons are properly connected to the CN12 Connector.

Note: When the fuse F1 or F2 are blown, replace with the same type of fuse.

4.1.9 Touch Screen Maintenance

It requires periodic cleaning in following conditions.

1. Whenever some chips fall on DISPLAY Unit.
2. Whenever some coolant falls.
3. Whenever some dusts are accumulated on the screen.
4. Whenever greasy, any kind of mists, or dusts appear on the screen.
5. If the display is not clear or clean.

Clean the touch screen by following method.

Go to Utilities, PC Settings, Touch “ Touch screen cleaning “ Icon. We will get blank display of screen. It makes easy to view the dust portions on the screen and makes easy to clean the touch screen.

Do:

1. Use standard glass cleaning liquid and pour on the clean cloth and wipe on touch screen.
2. Clean with soft clothes.

Don't:

1. Do not spray glass cleaning liquid directly on the touch screen. Use only with clean cloth.
2. Do not use any harder or sharper materials to clean the touch screen. Use only clean soft cloth.
3. Do not use sponge and hands to clean touch screen.
4. Do not put much pressure while cleaning the touch screen

4.1.10 Mode of Operation of PCNC

The operation modes in PCNC can be broadly divided into two: the on-line mode and the off-line mode. Although the operation mode can be switched using the switch settings, it cannot be switched in the middle of operation (the PCNC references the system number switches only at system start-up.)

The contents in each operation mode are as shown in Table 4.16.

** If the system is started after the system number switches are set into undefined numbers, or the hardware check program has not been booted and the system number switches are set as B & C, “Boot Log” Message will come and the system will not start normally.

Table 4.1.10.1: Operation Mode Content

System Number Switch	Mode of operation	Operation Mode Type
0	Normal operation mode	O
1	Normal operation mode	O
2	Normal operation mode	O
4	Ladder development mode	O
E	Memory operation mode	**

ONLINE = O, OFFLINE = * *

4.1.11 Self - Diagnosis Function Specification

While Boot up of PCNC

Processing classification number display	Progress message display corresponding to the content of NC power input processing.	LED Display				System number SW	Cause of failure
		4	3	2	1		
1	LED PORT WRITE	O	O	O	●	0, 1, 2, 4, E	JCP20 PCB
2	YENET RAM CHECK	O	O	●	O	0, 1, 2, 4, E	JCP20 PCB
3	SYSTEM-SW READ	O	O	●	O	0, 1, 2, 4, E	JCP20 PCB
4	FLASH TOTAL CHECK	O	O	●	O	0, 1, 2	JCP20 PCB
5	JIF PORT READ	O	O	●	O	0, 1, 2, 4, E	JCP20 PCB
6	REV.READ	O	O	●	O	0, 1, 2, 4, E	JCP20 PCB
7	ISA-RAM CHECK	O	O	●	O	0, 1, 2, 4, E	JCP20 PCB
8	YENET INITIAL	O	●	O	●	0, 1, 2, 4, E	JCP20 PCB
9	CMOS CLEAR	O	●	O	●	0, 1, 2, 4,	JCP20 PCB
10	CMOS TOTAL CHECK	O	●	O	●	0, 1, 2,	JCP20 PCB
11	PARAMETER READ	O	●	O	O	0, 1, 2, 4,	JCP20 PCB
12	MOTION INITIAL	O	●	●	●	0, 1, 2, 4,	JCP20 PCB, SERVO
13	LADDER START	O	●	●	●	0, 1, 2, 4	JCP20 PCB
14	INTEX INITIAL	●	O	O	O	0, 1, 2, 4, E	
15	TASK SETUP	●	O	●	O	0, 1, 2, 4, E	
16	JTABLE SET	●	●	O	O	0, 1, 2, 4, E	JCP20 PCB

(b) Parameter setting is incorrect.

- Check the setting for parameter pm2001 D0. If the setting for pm2440 is “0” while “pm2001 D0 = 1”, an axis does not move.

pm2001 D0 = 1	Feedrate in the skip feed mode (G31) is the feedrate set for parameter pm 2440.
pm2001 D0 = 0	Feedrate in the skip feed mode (G31) is the feedrate specified with an F code.

- Check the setting for parameters pm5011 D0 to D2.
- Set the signal status at the start of the processing when the SKIP signal is input.

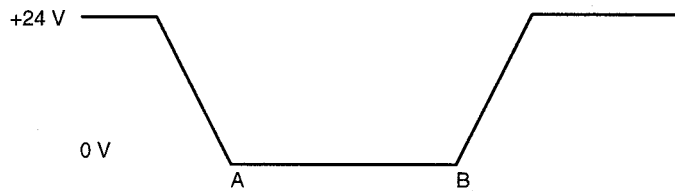

FIGURE 4.1.11.1:

- If “0”, processing starts at the point where 24 V falls to 0V.
- After changing the setting, be sure to turn OFF the power once and turn it ON again.
- Check the setting for parameters pm5010 D0 to D0.
The setting for this parameter determines ENABLE/DISABLE of the control circuit for the “SKIP” input.
 - Set “1” to use the skip function.
 - After changing the setting for this parameter always turn OFF the power - once and then turn it ON again.

4.1.12 Hard Drive Mounting Replacement

Appendix 1

TABLE OF CNC INPUT/OUTPUT SIGNAL DIAGNOSIS NUMBERS

Appendix 1 describes the diagnosis numbers of the input/output signals between the CNC and the PLC

1.1	Input Signals (PLC → CNC)	A1-2
1.1.1	Operation Mode Control Signals	A1-2
1.1.2	Servo Axis Control Signals (X-Axis to 5th Axis)	A1-5
1.1.3	Spindle Control	A1-7
1.2	Output Signals (CNC → PLC)	A1-9
1.2.1	Operation Mode Control Signals	A1-9
1.2.2	Servo Axis Control Signals (X-Axis to 5th Axis)	A1-12
1.2.3	Spindle Control	A1-14
1.2.4	Contants	A1-17

APPENDIX 1.1 Input Signals (PLC→CNC)

1.1.1 Operation Mode Control Signals Table

Appendix Table 1.1 Operation Mode Control Signals

	7	6	5	4	3	2	1	0
#3000		MEM	MDI		STP	H	JOG	RT
	Operation Mode							
#3002	MP4	MP2	MP1	JV16	JV8	JV4	JV2	JV1
	Manual Pulse/Step Multiplication Setting			Manual Jog Feedrate Selection				
#3003		ROV4	ROV2	ROV1			*SP	ST
	Rapid Traverse Override						Automatic Operation Stop	Automatic Operation Start
#3004						STLK	ERS	MRD
						Start Interlock	External Reset	Machine Ready
#3005	ERR2	ERR1	ERR0				EXTC	SVON
	External Error Detection						Time Count	External Servo ON
#3006	AFL	MLK		DRN		DLK	ABS	SBK
	Auxiliary Function Lock	Machine Lock		Dry Run		Display Lock	Manual Absolute	Single-Block
#3007		F1				EDT LK	ZRN2	ZRN
		F1-Digit Select				Edit Lock	Second Reference Point Return	Reference Point Return
#3008						CPRN	HOFS	
						Point Return Interruption	Mode Handle Automatic Offset	

Appendix Table 1.1 Operation Mode Control Signals Table (cont'd)

	7	6	5	4	3	2	1	0
#3009								
#3012	TLCTIN	TLSKP		TLCH			STSEL1	STSELO
	Tool Life Count Ignore	Tool Skip		Life Expiration Check Request			Stored Stroke Limit Check	
#3016		GOS2						
		Second S-curve form Decel/Accel						
#3023	TLTGN7	TLTGN6	TLTGN5	TLTGN4	TLTGN3	TLTGN2	TLTGN1	TLTGN0
	Tool Life Management (Life Expiration Group Number)							
#3025	TGN7	TGN6	TGN5	TGN4	TGN3	TGN2	TGN1	TGN0
	Tool Life Group Number (Tool Skip Group Number)							
#3030	ED7	ED6	ED5	ED4	ED3	ED2	ED1	ED0
	External Data Input							
#3031	ED15	ED14	ED13	ED12	ED11	ED10	ED9	ED8
	External Data Input							
#3032	ED23	ED22	ED21	ED20	ED19	ED18	ED17	ED16
	Ext. Data Input							
#3033	ED31	ED30	ED29	ED28	ED27	ED26	ED25	ED24
	Ext. Data Input							
#3034	EDCL	EDAS2	EDAS1	EDAS0	EDSD	EDSC	EDSB	EDSA
	External Data Selection Strobe Input	External Data Axis Selection			External Data Selection			

Appendix Table 1.1 Operation Mode Control Signals Table (cont'd)

	7	6	5	4	3	2	1	0
#3036					PINT			
	Program Interrupt							
#3037	1HP7	1HP6	1HP5	1HP4	1HP3	1HP2	1HP1	1HP0
	PG Pulse Input Monitor							
#3038	2HP7	2HP6	2HP5	2HP4	2HP3	2HP2	2HP1	2HP0
	PG Pulse Input Monitor							
#3039	3HP7	3HP6	3HP5	3HP4	3HP3	3HP2	3HP1	3HP0
	PG Pulse Input Monitor							
#3040	OVC	OPT	BDT	OV16	OV8	OV4	OV2	OV1
	Override Cancel	Optional Stop	Optional Block Delete	Feedrate Override				
#3041					FIN	RWDH	RWD	EOP
					MT Function Fin.	High-speed Rewind	Rewind	End of Program
#3042	BDT9	BDT8	BDT7	BDT6	BDT5	BDT4	BDT3	BDT2
	Optional Block Delete							
#3046	UI 7	UI 6	UI 5	UI 4	UI 3	UI 2	UI 1	UI 0
	Interface Input							
#3047	UI 15	UI 14	UI 13	UI 12	UI 11	UI 10	UI 9	UI 8
	Interface Input							
#3048	UI 23	UI 22	UI 21	UI 20	UI 19	UI 18	UI 17	UI 16
	Interface Input							
#3049	UI 31	UI 30	UI 29	UI 28	UI 27	UI 26	UI 25	UI 24
	Interface Input							

1.1.2 Servo Axis Control Signals (X-axis to 5th-axis)

Appendix Table 1.2 Servo Axis Control Signals (X-axis to 5th-axis)

	7	6	5	4	3	2	1	0
#3070				H5	H4	HZ	HY	HX
						Pulse Handle Control Axis		
#3071				+5	+4	+Z	+Y	+X
						Manual Feed Axis/Direction Selection		
#3072				-5	-4	-Z	-Y	-X
						Manual Feed Axis/Direction Selection		
#3073				*DC5	*DC4	*DCZ	*DCY	*DCX
						Reference Point Return Decel. LS		
#3074				*+OT5	*+OT4	*+OTZ	*+OTY	*+OTX
						Overtravel LS		
#3075				*-OT5	*-OT4	*-OTZ	*-OTY	*-OTX
						Overtravel LS		
#3076				*+EDLS5	*+EDLS4	*+EDLSZ	*+EDLSY	*+EDLSX
						External Deceleration LS		
#3077				*-EDLS5	*-EDLS4	*-EDLSZ	*-EDLSY	*-EDLSX
						External Deceleration LS		
#3078				*IT5	*IT4	*ITZ	*ITY	*ITX
						Axis Interlock		
#3079				SVOF5	SVOF4	SVOFZ	SVOFY	SVOFX
						Axis Servo OFF		
#3080				2H5	2H4	2HZ	2HY	2HX
						No. 2 Pulse Handle Axis Selection		

Appendix Table 1.2 Servo Axis Control Signals (X-axis to 5th axis) (cont'd)

	7	6	5	4	3	2	1	0
#3081				3H5	3H4	3HZ	3HY	3HX
				No. 3 Pulse Handle Axis Selection				
#3082				MI5	MI4	MIZ	MIY	MIX
				Mirror Image Axis Selection				
#3083				DTCH5	DTCH4			
				Axis Disconnection Designation				
#3084				AMLK5	AMLK4	AMLKZ	AMLKY	AMLKX
				Axis Dependent Machine Lock				
#3086				TRQ1-5	TRQ1-4	TRQ1-Z	TRQ1-Y	TRQ1-X
				Torque Limit Input 1				
#3087				TRQ2-5	TRQ2-4	TRQ2-Z	TRQ2-Y	TRQ2-X
				Torque Limit Input 2				
#3101				G002 5	G002 4	G002 Z	G002 Y	G002 X
				No. 2 G00 Mode				
#3104				*+IT5	*+IT4	*+ITZ	*+ITY	*+ITX
				Direction-specified Axis Interlock (positive direction)				
#3105				*-IT5	*-IT4	*-ITZ	*-ITY	*-ITX
				Direction-specified Axis Interlock (positive direction)				
#3106	PMO NIN8	PMO NIN7	PMO NIN6	PMO NIN5	PMO NIN4	PMO NIN3	PMO NIN2	PMO NIN1
	High-speed Position Monitor Range Designation							

1.1.3 Spindle Control

Appendix Table 1.3 Spindle Control

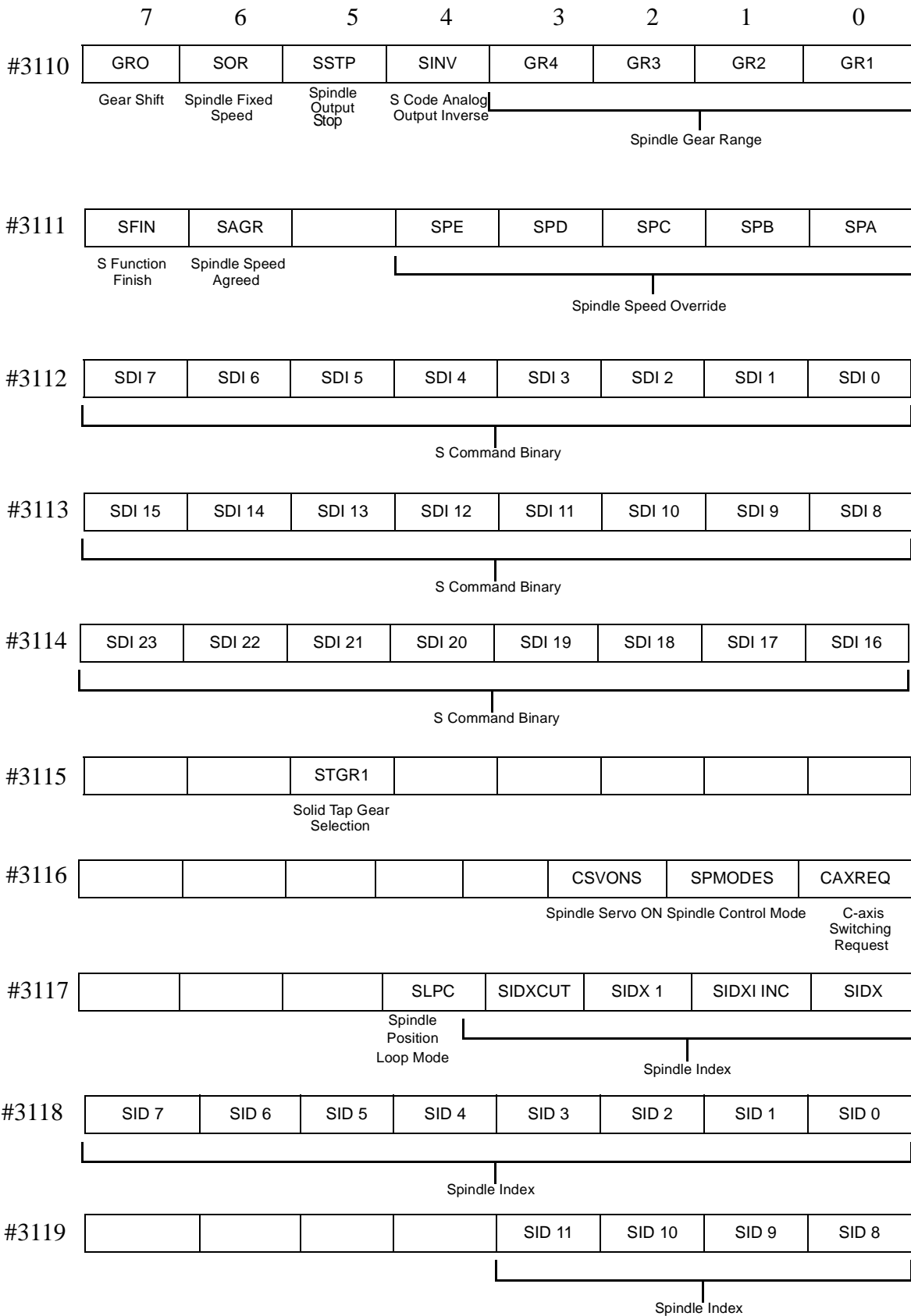

Appendix Table 1.3 Spindle Control (cont'd)

	7	6	5	4	3	2	1	0
#3120		SPSSC	SPTLL	SPTLH	SPREV	SPFWD	SPEMG	SPRDY
		Soft-start Cancel	Torque Limit L	Torque Limit H	Reverse Rotation	Forward Rotation	Emergency Stop	Operation Ready
		Signals for YENET 1200 Compatible Inverter						
#3121				SPMGR	SPLGR	SPORT	SPPPI	SPCHW
				M Gear Selection	L Gear Selection	Orientation	Speed Controller P-PI Switchover	Winding Switchover
				Signals for YENET 1200 Compatible Inverter				
#3122	SPD08	SPD07	SPD06	SPD05	SPD04	SPD03	SPD02	SPD01
	Oriented Spindle Stop Address							
#3123					SPD12	SDP11	SDP10	SPD09
					Oriented Spindle Stop Address			

1.2.1 Operation Mode Control Signals

Appendix Table 1.4 Operation Mode Control Signals

	7	6	5	4	3	2	1	0
#3500				WARNS	IERS	*ESP S	RSTS	ALMS
				Output-Warning State	Output-Input Error State	Output-EMG. Stop State	Output-Resetting	Output-Alarm State
#3501				G00S2			AUTO	MAN
				Output-No. 2 G00 Mode State			Output-Automatic Mode	Output-Manual Mode
#3502	ONPB	OHT		*BALM	SSW3	SSW2	SSW1	SSW0
	Output-CNC Control Monitor				Output-System No. Switch Monitor			
#3503			PWLOSS	ESP	SVALM		BK	SVON S
			Output-Power Loss Detection Monitor	Emergency Stop	Output-Servo Alarm		Output-Brake ON Monitor	Output-Servo ON Monitor
#3504	WHO ERR	ES END	ER END					
	External Data Input Complete Output							
#3505								
#3506	CALEN4	CALEN3	CALEN2	CALEN1	SSWS 3	SSWS 2	SSWS 1	SSWS 0
	Calendar Output				Output-System No. Setting Monitor			
#3507	MSKPO	EXCLFN	WKOFK					
	Output-Manual Skip Mode							
#3508	TLCHA	TLCHB	TLCEND	TLANS				
	Output Tool Change Signal	New Tool Selection	Life Expiration Check Complete Output	Life Expired/ Not Expired Output				
	Tool Life Control							
#3514								HIN1
								Output-Direct Processing Signal Monitor

Appendix Table 1.4 Operation Mode Control Signals (cont'd)

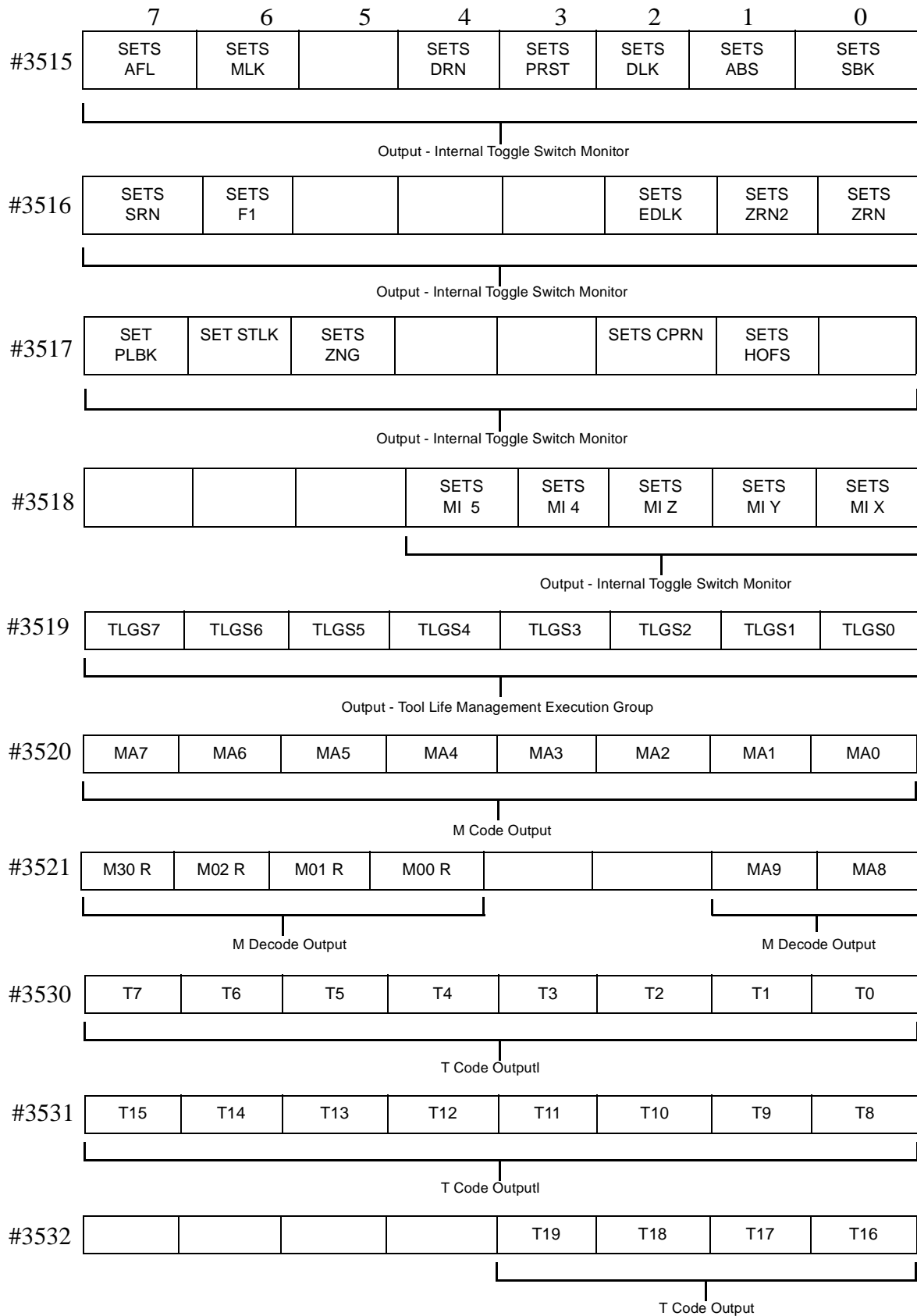

Appendix Table 1.4 Operation Mode Control Signals (cont'd)

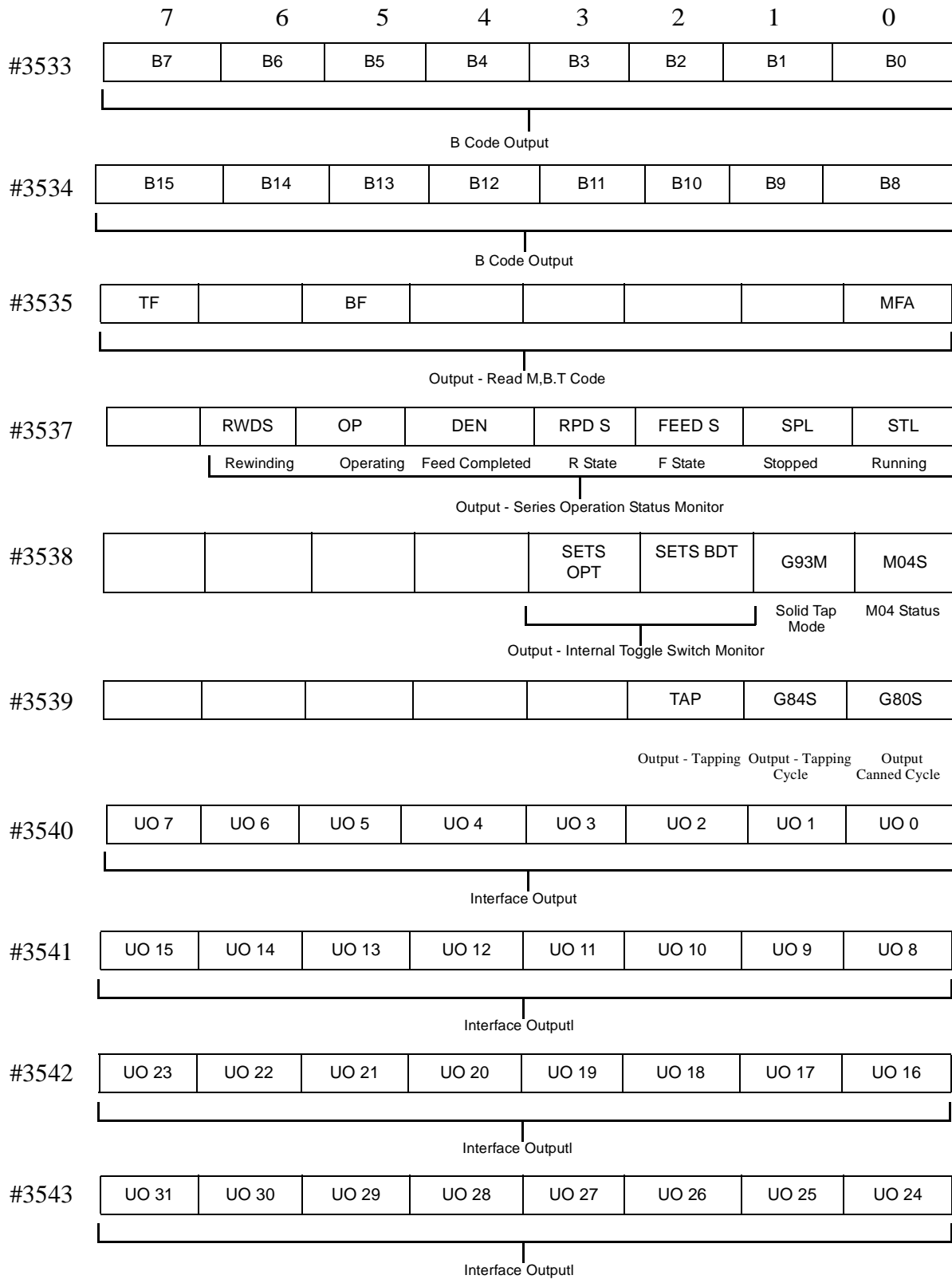

1.2.2 Servo Axis Control (X -Axis to 5th Axis)

Appendix Table 1.5 Servo Axis Control (X-Axis to 5th Axis)

	7	6	5	4	3	2	1	0
#3615				FUP5	FUP4	FUPZ	FUPY	FUP X
Output - Follow-up Monitor								
#3616				PSET5	PSET4	PSETZ	PSETY	PSETX
Output - PSET Status Monitor								
#3617				DTCH 5S	DTCH 4S			
Output - Axis Disconnect Status								
#3618				AMLK 5S	AMLK 4S	AMLK ZS	AMLK YS	AMLK XS
Output - Axis Machine Lock Status								
#3619				TROLIM5	TROLIM4	TROLIMZ	TROLIMY	TROLIMX
Torque Limit Status								
#3628				G0025S	G0024S	G002ZS	G002YS	G002XS
Output - No. 2 G00 Mode								
#3629				ABSAL5	ABSAL4	ABSALZ	ABSALY	ABSALX
Output - Absolute Position Detection Error								
#3630				ZP5	ZP4	ZPZ	ZPY	ZPX
Output - At the Reference Point								
#3631				2ZP5	2ZP4	2ZPZ	2ZPY	2ZPX
Output - At the Second Reference Point								
#3632				3ZP5	3ZP4	3ZPZ	3ZPY	3ZPX
Output - At the Third Reference Point								
#3633				4ZP5	4ZP4	4ZPZ	4ZPY	4ZPX
Output - At the Fourth Reference Point								
#3634	PMON8	PMON7	PMON6	PMON5	PMON4	PMON3	PMON2	PMON1
Position Monitor Output								
#3635							PMON10	PMON9
Position Monitor Output								

Appendix Table 1.5 Servo Axis Control (X-Axis to 5th Axis) (cont'd)

	7	6	5	4	3	2	1	0
#3637				XBA5	XBA4	XBAZ	XBAY	XBAX
				External Encoder Battery Alarm Monitor				
#3638				ZPSET5	ZPSET4	ZPSETZ	ZPSETY	ZPSETX
				Zero Position Set Monitor				

1.2.3 Spindle Control

Appendix Table 1.6 Spindle Control

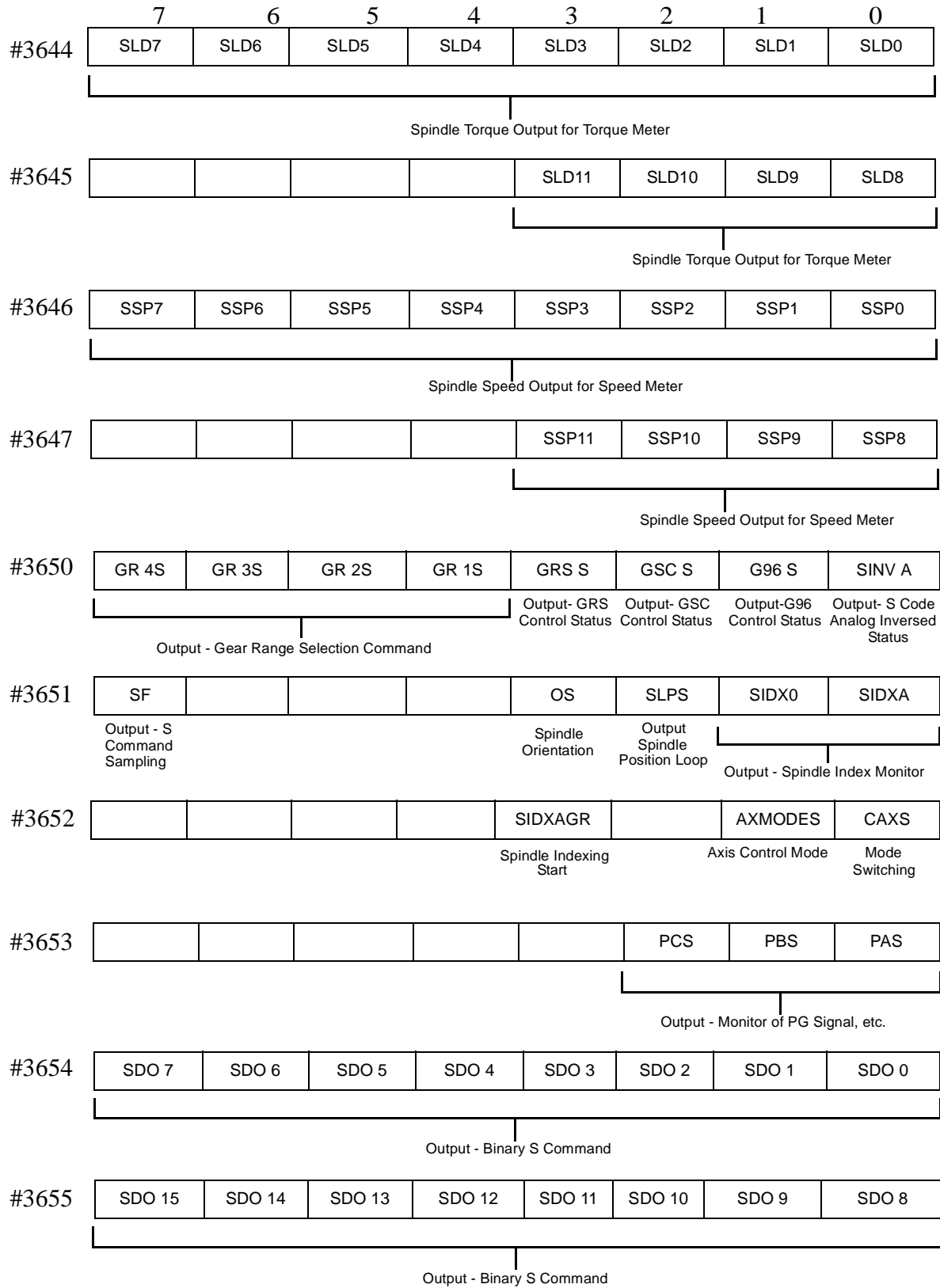

Appendix Table 1.6 Spindle Control (cont'd)

	7	6	5	4	3	2	1	0
#3656	SDO 23	SDO 22	SDO 21	SDO 20	SDO 19	SDO 18	SDO 17	SDO 16
Output - Binary S Command								
#3657	SARM7	SARM6	SARM5	SARM4	SARM3	SARM2	SARM1	SARM0
Output - Actual Spindle Speed Monitor								
#3658	SARM15	SARM14	SARM13	SARM12	SARM11	SARM10	SARM9	SARM8
Output - Actual Spindle Speed Monitor								
#3659	SARM23	SARM22	SARM21	SARM20	SARM19	SARM18	SARM17	SARM16
Output - Actual Spindle Speed Monitor								
#3660	SPCHWE	SPORE	SPORG	SPTLE	SPTDET	SPSDET	SPAGR	SPZSPD
	Winding Switchover Complete	Orientation Complete	Load Axis Zero Point	Torque Limit	Torque Detection	Speed Detection	Speed Agreed	Zero Speed Detection
Signals for YENET 1200 Compatible Inverter								
#3661							SPTALM-1	SPFLT-1
							Spindle Alarm	Spindle Fault
Signals for YENET 1200 Compatible Inverter								
#3740	LDX-7	LDX-6	LDX-5	LDX-4	LDX-3	LDX-2	LDX-1	LDX-0
X-axis Load Data (L)								
#3741	LDX-15	LDX-14	LDX-13	LDX-12	LDX-11	LDX-10	LDX-9	LDX-8
X-axis Load Data (H)								
#3742	LDY-7	LDY-6	LDY-5	LDY-4	LDY-3	LDY-2	LDY-1	LDY-0
Y-axis Load Data (L)								

Appendix Table 1.6 Spindle Control (cont'd)

	7	6	5	4	3	2	1	0
#3743	LDY-15	LDY-14	LDY-13	LDY-12	LDY-11	LDY-10	LDY-9	LDY-8
Y-axis Load Data (L)								
#3744	LDZ-7	LDZ-7	LDZ-7	LDZ-7	LDZ-7	LDZ-7	LDZ-7	LDZ-7
Z-axis Load Data (L)								
#3745	LDZ-15	LDZ-14	LDZ-13	LDZ-12	LDZ-11	LDZ-10	LDZ-9	LDZ-8
Z-axis Load Data (H)								
#3746	LD4-7	LD4-7	LD4-7	LD4-7	LD4-7	LD4-7	LD4-7	LD4-7
4th-axis Load Data (L)								
#3747	LD4-15	LD4-14	LD4-13	LD4-12	LD4-11	LD4-10	LD4-9	LD4-8
4th-axis Load Data (H)								
#3748	LD5-7	LD5-6	LD5-5	LD5-4	LD5-3	LD5-2	LD5-1	LD5-0
5th-axis Load Data (L)								
#3749	LD5-15	LD5-14	LD5-13	LD5-12	LD5-11	LD5-10	LD5-9	LD5-8
5th-axis Load Data (H)								

1.2.4 Constants

Appendix Table 1.7 Constant

	7	6	5	4	3	2	1	0
#3996	0	0	0	0	0	0	0	0
	Constants							
#3997	0	0	0	0	0	0	0	0
	Constants							
#3998	0	0	0	0	0	0	0	0
	Constants							
#3999	0	0	0	0	0	0	0	1
	Constants							

Appendix **2**

Alarm Table

Appendix 2 describes the classification and contents of alarms

- 2.1 Classification of AlarmsA2-2
- 2.2 Alarm Table (PCNC)A2-3
- 2.3 TroubleshootingA2-21

APPENDIX 2.1 PCNC CLASSIFICATION of ALARMS				
No.	Contents	Stop Mode	Output	How to Reset
0000 - 0049	Errors related with edit and operation. Occuring in the background mode also.	Block Stop	Input error alarm	RESET
0050 - 0099	Errors related with edit and operation. Not occuring in the background mode.	Block Stop	Input error alarm	RESET Power OFF for #0050 and # 0051
0100 - 0499	Program Error (occurring in a series)	Block Stop	Input error alarm	RESET
1000 - 1099	Program Error (occurring over multiple series) DNC, COMS total, etc....	Block Stop	Input error alarm	RESET
2000 - 2199	Machine related error OT, reference point return, machine ready, in-position, etc.....	Stop after deceleration, or immediate stop	Alarm	Reset operation after removing the cause. With the alarm caused by the machine ready signal, if it occurs in the first power ON operation, it is automatically reset.
3000 - 3299	Servo and spindle related alarm ESP, CPU, mutual monitoring in NC.	Immediate stop or servo off	Alarm	Reset after removing the cause. With the SVOFF alarm, it is automatically reset by the SVON.
8000 - 8049	Memory check error (ROM, RAM) Watchdog timer error Offline error	Immediate stop or servo off	Alarm	For maintenance CPU Halt Switching to the special maintenance screen
9000 - 9049	Errors related with edit and operation. Occuring in the background mode also.	Not Stopped	Back-ground error output	RESET or with reset softkey.
BAT. indication BAT.AXIS	Battery error Encoder Alarm	Not Stopped	No output	Changing the battery
Warning Message	Key operation error, edit operation error (Not serious operation error)	Not Stopped	Warning	Next key operation

APPENDIX 2.2 PCNC ALARM TABLE

Alarm No.	Description
alarm.25	There is an error in the setting of parameters.
alarm.50	The parameter which is made valid after power off/on operation has been set.
alarm.51	The parameter which is made valid only when the program area is cleared has been set.
alarm.61	There is an error in the designation of data in external data input.
alarm.62	The program designated by the external data number search is not found.
alarm.100	Overflow has occurred with one-block buffer (128 characters).
alarm.101	There is no data specified following an address, or the data is specified without address.
alarm.102	"-" or "." is not used correctly.
alarm.103	Illegal character is specified in the significant information area.
alarm.104	Overflow has occurred with the input numerical value (more than 9 characters).
alarm.105	An axis not defined as an axis is designated.
alarm.106	The same address is designated more than one time in one block.
alarm.107	Nesting of "() " error, ")" is used without ")", "(" and ")" are not used in pairs.
alarm.110	More than one M code is designated in one block although multiple M code option is not selected.
alarm.111	The number of digits in the specified M code is larger than the allowable limit.
alarm.112	M90 and M91 are not designated in a block without other commands. There is no P command in the M91 block.
alarm.113	There is an error in the designation of an internal M code.
alarm.114	M90/M91 is designated although designation is not allowed.
alarm.115	There is an error in the M191 command.
alarm.116	M93 is designated although designation is not allowed.
alarm.125	M, S, or T is designated although designation of M, S, or T is not allowed.
alarm.126	There is no M02/M30 command in memory mode or tape mode operation.
alarm.127	*In the mirror image mode, an illegal G is designated.& *Mirror image is turned ON in the mirror image prohibited mode.
alarm.130	More than one S code is designated in one block although multiple S control option is not selected.
alarm.131	The number of digits in the specified S code is larger than the allowable limit.
alarm.140	The number of digits in the specified T code is larger than the allowable limit.
alarm.144	The number of digits in the specified B code is larger than the allowable limit.

Alarm No.	Description
alarm.150	Offset number is too large.
alarm.151	Offset number specified in H/D switching is too large.
alarm.152	Offset number H is not designated.
alarm.160	An illegal G code is designated. Or a G code for which the corresponding option is not selected is designated
alarm.161	G codes which cannot be used in combination in one block are designated.
alarm.162	An address which is mandatory is not specified.
alarm.163	An illegal G is designated in the high-speed mode operation section.
alarm.170	An illegal G code is designated in a canned cycle.
alarm.171	G70 - G72 is designated in other than a canned cycle.
alarm.172	R-point level return is designated in G77 (back boring) canned cycle.
alarm.174	In G73/G83, Q and I are not designated. G73/G83 is designated with Q = I = 0.
alarm.175	In G70 - G72, designation of address is incorrect.
alarm.180	At the start-up of tool radius offset or nose R offset mode,& *There are no axis move commands within 3 blocks.& *M00, M01, M02, or M30 is designated.& *Circular interpolation mode is designated.
alarm.181	The tool radius offset or nose R offset mode ends in the circular interpolation mode.
alarm.182	An illegal G code is designated in the tool radius offset or nose R offset mode.
alarm.183	In the tool radius offset or nose R offset mode, offset plane has been changed. Circular arc is designated outside the offset plane.
alarm.184	In the tool radius offset or nose R offset mode, point of intersection cannot be obtained.
alarm.185	In the tool radius offset or nose R offset mode, the shape causing reversed tool movement is designated.
alarm.186	In the tool radius offset or nose R offset mode, a system variable for which buffering is not allowed is designated
alarm.187	In the tool radius offset or nose R offset mode, interference is detected.
alarm.188	In the tool radius offset or nose R offset mode, automatic interference correction is not possible.
alarm.189	Offset mode error (work area has been destroyed, or no output data in data output operation)
alarm.190	In circular interpolation commands, a circle of "0" radius has been specified.
alarm.191	In circular interpolation, commands including three axes are designated. In helical interpolation, axes exceeding the number of controllable axes are designated.

Alarm No.	Description
alarm.186	In the tool radius offset or nose R offset mode, a system variable for which buffering is not allowed is designated.
alarm.192	The plane cannot be defined from the given circular interpolation commands. In circular interpolation commands of four or more axes are designated.
alarm.193	The center cannot be obtained from the designated R.
alarm.194	Tool length offset or tool position offset is designated in the circular interpolation mode.
alarm.196	Chamfering or comer rounding cannot be designated.
alarm.197	Chamfering or comer rounding designation plane error has occurred.
alarm.198	Chamfering or comer rounding block creation impossible error has occurred.
alarm.200	In inputting an offset amount by using a program, a number designated with P is larger than the allowable limit.
alarm.201	In inputting an offset amount by using a program, offset amount is too large. There is an error in the format.
alarm.202	In "G10 Q2" (inputting work coordinate system shift amount by program), a number designated with P is larger than the allowable limit.
alarm.210	In user macro, the value of constant is outside the allowable range.
alarm.211	The number of cancel codes for G67 is too many.
alarm.212	There is an error in the format.
alarm.213	A value not defined as a variable number is used.
alarm.214	A variable used in replace statement is the variable which cannot be used for this operation.
alarm.215	The nesting level of "[" exceeds the allowable limit.
alarm.216	The nesting level of macro program call exceeds the allowable limit.
alarm.217	DO - END is not used in pairs.
alarm.218	The numbers of brackets "[" and "]" do not agree with each other.
alarm.219	In "DO M", 1 (m (3 is not satisfied.
alarm.220	In "GOTO n", "n" is outside the allowable range or "n" is not found.
alarm.221	In a macro program, division by "0" is executed.
alarm.222	Square root of a negative value.
alarm.223	Floating point data exceeds the allowable range.
alarm.224	In modal call (G66), axis command is specified with M99 return designation.

Alarm No.	Description
alarm.225	Overflow has occurred with operation stack.
alarm.226	Execution of the following functions was impossible: ASIN, ACOS, LN, SQRT.
alarm.227	Overflow has occurred during conversion into integer.
alarm.228	Overflow has occurred with the input data for the BCD function.
alarm.229	There is an error in the format of the BIN function.
alarm.230	Overflow has occurred as the result of execution of the EXP function.
alarm.240	Reference point return has not been completed with the axis for which G29, G30 is designated.
alarm.241	Reference point return is invalid for the axis for which G28 is designated.
alarm.250	An illegal code has been designated in a solid tap program.
alarm.255	An C command is designated for the spindle in the spindle control mode.
alarm.256	An S command is designated for the spindle in the C-axis control mode.
alarm.260	*There is no P or Q command in the M98 block.& *There is no P command in the G65/G66, G25 block.& *Both G25 and M98/M99 are designated in the same block.
alarm.261	Nesting level of M98 subprogram call or G25 exceeds the allowable limit.
alarm.262	In a program that calls a micro program by G, M, or T code (M98, M99, G65, G66, G25), the designated program number or sequence number is not found.
alarm.263	An attempt was made to start a program by executing address search after buffering subprogram or macro call.
alarm.264	M99 is used in copy program when an attempt was made to execute the program copy function.
alarm.270	* I or J command is not designated in the G106 block.& * Neither I nor J command is designated in the G106 block.& * An axis other than X and Y is designated in the G106 block.
alarm.275	During program interruption, an illegal command is designated.
alarm.280	In the scaling mode, an illegal command is designated.
alarm.281	"There is an error in the format of G50/G51 block. Scaling value is "0".
alarm.285	The order of designation/cancellation of the following functions is incorrect: mirror image, scaling, rotation.
alarm.290	A sequence number is not found at the restart of the program.
alarm.291	The operation that changes the coordinate system is executed at the restart of the program.
alarm.292	At the restart of the program, an axis was moved by MDI intervention.

Alarm No.	Description
alarm.301	There are no tools registered in the designated tool group.
alarm.302	All tools in the designated tool group are in the skipped status.
alarm.310	In the coordinate rotation mode, an illegal G code is designated. Or G68 is designated in the tool radius offset mode
alarm.311	There is an error in the format of the G68, G69 command block.
alarm.312	In the coordinate rotation mode, an axis that cannot be designated is designated.
alarm.320	A work coordinate system that cannot be designated for the G54 - G59 J* work coordinate system shift program is selected. Or G54 - G59 is designated in the circular interpolation mode.
alarm.321	A local coordinate system is set although a work coordinate system is not set.
alarm.322	G53 is designated in incorrect conditions.
alarm.360	In circle cut commands, radius R < offset amount D.
alarm.361	In circle cutting, a plane other than the G 17 plane is selected.
alarm.362	There is an error in the format of circle cut program.
alarm.365	An illegal G code is designated in G45 - G48 mode.
alarm.370	There is no F command in a cutting program.
alarm.380	An axis command is designated in the G04, G40, G21 block.
alarm.381	An axis command is designated in the G10, G22, G23 block.
alarm.382	More than one area has been selected from No. 3 - No. 5 prohibited areas.
alarm.390	An execution program does not exist.
alarm.391	An execution program is being input.
alarm.392	An execution program is being edited.
alarm.393	A sequence number that does no exist is designated in M98 Q G25 commands.
alarm.395	Cycle start is executed after changing the mode from tape to memory, or from memory to tape.
alarm.396	During tape/direct operation, an attempt was made to return to the main program by interrupting program execution.
alarm.397	During tape/direct operation, operation interruption that does not allow the re-execution has been carried out.
alarm.400	An O number of five or more digits is designated.
alarm.401	An N number of five or more digits is designated.
alarm.402	A P number of five or more digits is designated.

Alarm No.	Description
alarm.406	Before the axis move, the axis is in the stored stroke limit No. 2 area.
alarm.407	Before the axis move, the axis is in the stored stroke limit No. 3 area.
alarm.408	Before the axis move, the axis is in the stored stroke limit No. 4 area.
alarm.409	Before the axis move, the axis is in the stored stroke limit No. 5 area.
alarm.411	Reference point return has not been completed (X-axis).
alarm.412	Reference point return has not been completed (Y-axis).
alarm.413	Reference point return has not been completed (Z-axis).
alarm.414	Reference point return has not been completed (4th-axis).
alarm.415	Reference point return has not been completed (5th-axis).
alarm.421	After the execution of G27, the axis has not returned to the reference point (X-axis).
alarm.422	After the execution of G27, the axis has not returned to the reference point (Y-axis).
alarm.423	After the execution of G27, the axis has not returned to the reference point (Z-axis).
alarm.424	After the execution of G27, the axis has not returned to the reference point (4th-axis).
alarm.425	After the execution of G27, the axis has not returned to the reference point (5th-axis).
alarm.431	Before the axis move, the axis has reached the entry prohibited area (outside) of stored stroke limit (X-axis)
alarm.432	Before the axis move, the axis has reached the entry prohibited area (outside) of stored stroke limit (Y-axis)
alarm.433	Before the axis move, the axis has reached the entry prohibited area (outside) of stored stroke limit (Z-axis)
alarm.434	Before the axis move, the axis has reached the entry prohibited area (outside) of stored stroke limit (4th - axis)
alarm.435	Before the axis move, the axis has reached the entry prohibited area (outside) of stored stroke limit (5th - axis)
alarm.480	The cylindrical interpolation command error has occurred.
alarm.481	A command error has occurred in the cylindrical interpolation mode.
alarm.482	The polar coordinate interpolation command error has occurred.
alarm.483	A command error has occurred in the polar coordinate interpolation mode.
alarm.484	Program interrupt has occurred in the cylindrical or polar coordinate interpolation mode.
alarm.491	In the G31 block, skip signal (1) has not been input.
alarm.492	In the G31 block, skip signal (2) has not been input.
alarm.494	When G31 is executed, the skip signal (1) is not ready.
alarm.495	When G31 is executed, the skip signal (2) is not ready.

Alarm No.	Description
alarm.1000	DNC time-out error has occurred.
alarm.1001	DNC DR line error has occurred.
alarm.1002	DNC packet length error has occurred.
alarm.1003	DNC 8251 error has occurred.
alarm.1004	DNC check sum error has occurred.
alarm.1005	DNC command error has occurred.
alarm.1006	DNC high-speed cutting mode error has occurred.
alarm.1007	DNC communication module diagnosis error has occurred.
alarm.1008	DNC CPU error has occurred.
alarm.1009	DNC 51 error has occurred.
alarm.1020	Start number of the battery backed-up memory storing the cell controller I/O link information is outside the allowable range.
alarm.1021	An interface error between the cell controller and COM in the cell controller system.
alarm.1041	Incorrect command has been made for the PLC control axis (X-axis).
alarm.1042	Incorrect command has been made for the PLC control axis (Y-axis).
alarm.1043	Incorrect command has been made for the PLC control axis (Z-axis).
alarm.1044	Incorrect command has been made for the PLC control axis (4th-axis).
alarm.1045	Incorrect command has been made for the PLC control axis (5th-axis).
alarm.1051	Axis has been changed while the control axis selected status signal is ON (X-axis).
alarm.1052	Axis has been changed while the control axis selected status signal is ON (Y-axis).
alarm.1053	Axis has been changed while the control axis selected status signal is ON (Z-axis).
alarm.1054	Axis has been changed while the control axis selected status signal is ON (4th-axis).
alarm.1055	Axis has been changed while the control axis selected status signal is ON (5th-axis).
alarm.1080	Execution of a program block has been stopped with the ERR 0 signal ON.
alarm.1090	Setting area total check error has occurred.
alarm.1091	Parameter area total check error has occurred.

Alarm No.	Description
alarm.1092	Battery backed-up memory area total check error has occurred.
alarm.1093	Offset and work coordinate system shift amount area total check error has occurred.
alarm.1094	Macro variable area total check error has occurred.
alarm.1095	Machining program area total check error has occurred.
alarm.1096	Tool life control data area total check error has occurred.
alarm.1098	The Fan is faulty. {Refer to A1-20}
alarm.1099	High temperature in the NC unit. {Refer to A1-20}
alarm.2001	Overtravel has occurred (X-axis).
alarm.2002	Overtravel has occurred (Y-axis).
alarm.2003	Overtravel has occurred (Z-axis).
alarm.2004	Overtravel has occurred (4th-axis).
alarm.2005	Overtravel has occurred (5th-axis).
alarm.2011	Axis has reached the stored stroke limit No. 1 area (X-axis).
alarm.2012	Axis has reached the stored stroke limit No. 1 area (Y-axis).
alarm.2013	Axis has reached the stored stroke limit No. 1 area (Z-axis).
alarm.2014	Axis has reached the stored stroke limit No. 1 area (4th-axis).
alarm.2015	Axis has reached the stored stroke limit No. 1 area (5th-axis).
alarm.2020	More than two areas are made valid at the same time among No. 2 - No. 5 areas.
alarm.2021	Axis has reached the outside of the stored stroke limit No. 2 area (X-axis).
alarm.2022	Axis has reached the outside of the stored stroke limit No. 2 area (Y-axis).
alarm.2023	Axis has reached the outside of the stored stroke limit No. 2 area (Z-axis).
alarm.2024	Axis has reached the outside of the stored stroke limit No. 3 area (X-axis).
alarm.2025	Axis has reached the outside of the stored stroke limit No. 3 area (Y-axis).
alarm.2026	Axis has reached the outside of the stored stroke limit No. 3 area (Z-axis).
alarm.2027	Axis has reached the outside of the stored stroke limit No. 4 area (X-axis).
alarm.2028	Axis has reached the outside of the stored stroke limit No. 4 area (Y-axis).
alarm.2029	Axis has reached the outside of the stored stroke limit No. 4 area (Z-axis).
alarm.2031	Axis has reached the outside of the stored stroke limit No. 5 area (X-axis).
alarm.2032	Axis has reached the outside of the stored stroke limit No. 5 area (Y-axis).

Alarm No.	Description
alarm.2033	Axis has reached the outside of the stored stroke limit No. 5 area (Z-axis).
alarm.2040	Axis has reached the inside of the stored stroke limit No. 2 area.
alarm.2041	Axis has reached the inside of the stored stroke limit No. 3 area.
alarm.2042	Axis has reached the inside of the stored stroke limit No. 4 area.
alarm.2043	Axis has reached the inside of the stored stroke limit No. 5 area.
alarm.2044	The end point does not lie on the circle in manual circular interpolation type 2.
alarm.2045	The start point does not exist on the circle in manual circular interpolation type 1.
alarm.2046	In manual circular interpolation, depth of cut is too large.
alarm.2051	When the separately installed PG is used for reference point return, the deceleration LS is turned from OFF to ON before the C-phase is latched (X-axis).
alarm.2052	When the separately installed PG is used for reference point return, the deceleration LS is turned from OFF to ON before the C-phase is latched (Y-axis).
alarm.2053	When the separately installed PG is used for reference point return, the deceleration LS is turned from OFF to ON before the C-phase is latched (Z-axis).
alarm.2054	When the separately installed PG is used for reference point return, the deceleration LS is turned from OFF to ON before the C-phase is latched (4th-axis).
alarm.2055	When the separately installed PG is used for reference point return, the deceleration LS is turned from OFF to ON before the C-phase is latched (5th-axis).
alarm.2060	The reference point return (low-speed type) is executed in the manual skip B (measuring) mode.
alarm.2061	Reference point return area error has occurred (X-axis).
alarm.2062	Reference point return area error has occurred (Y-axis).
alarm.2063	Reference point return area error has occurred (Z-axis).
alarm.2064	Reference point return area error has occurred (4th-axis).
alarm.2065	Reference point return area error has occurred (5th-axis).
alarm.2070	After the completion of measurement in the manual skip (A/B) mode, measuring cycle is executed again without returning the contact detection axis.
alarm.2071	Reference point return position error has occurred (X-axis).
alarm.2072	Reference point return position error has occurred (Y-axis).
alarm.2073	Reference point return position error has occurred (Z-axis).

Alarm No.	Description
alarm.2074	Reference point return position error has occurred (4th-axis).
alarm.2075	Reference point return position error has occurred (5th-axis).
alarm.2081	In reference point return, the deceleration LS is turned OFF after it has been turned ON once and then turned ON again (X-axis).
alarm.2082	In reference point return, the deceleration LS is turned OFF after it has been turned ON once and then turned ON again (Y-axis).
alarm.2083	In reference point return, the deceleration LS is turned OFF after it has been turned ON once and then turn ON again (Z-axis).
alarm.2084	In reference point return, the deceleration LS is turned OFF after it has been turned ON once and then turn again (4th-axis).
alarm.2085	In reference point return, the deceleration LS is turned OFF after it has been turned ON once and then turned ON again (5th-axis).
alarm.2091	According to the parameter setting, retraction operation must be made in reference point return operation (X-axis).
alarm.2092	According to the parameter setting, retraction operation must be made in reference point return operation (Y-axis).
alarm.2093	According to the parameter setting, retraction operation must be made in reference point return operation (Z-axis).
alarm.2094	According to the parameter setting, retraction operation must be made in reference point return operation (4th-axis).
alarm.2095	According to the parameter setting, retraction operation must be made in reference point return operation (5th-axis).
alarm.2101	P-SET error has occurred (X-axis).
alarm.2102	P-SET error has occurred (Y-axis).
alarm.2103	P-SET error has occurred (Z-axis).
alarm.2104	P-SET error has occurred (4th-axis).
alarm.2105	P-SET error has occurred (5th-axis).
alarm.2111	Absolute position overflow has occurred with the absolute position detection function(X-axis).
alarm.2112	Absolute position overflow has occurred with the absolute position detection function(Y-axis).

Alarm No.	Description
alarm.2113	Absolute position overflow has occurred with the absolute position detection function(Z-axis).
alarm.2114	Absolute position overflow has occurred with the absolute position detection function(4th-axis).
alarm.2115	Absolute position overflow has occurred with the absolute position detection function(5th-axis).
alarm.2131	Difference in axis positions between the position at the previous power off and the position at the start-up of the absolute position detection function is excessively large (X-axis).
alarm.2132	Difference in axis positions between the position at the previous power off and the position at the start-up of the absolute position detection function is excessively large (Y-axis).
alarm.2133	Difference in axis positions between the position at the previous power off and the position at the start-up of the absolute position detection function is excessively large (Z-axis).
alarm.2134	Difference in axis positions between the position at the previous power off and the position at the start-up of the absolute position detection function is excessively large (4th-axis).
alarm.2135	Difference in axis positions between the position at the previous power off and the position at the start-up of the absolute position detection function is excessively large (5th-axis).
alarm.2141	Reference point return movement has been interrupted due to mode change (X-axis).
alarm.2142	Reference point return movement has been interrupted due to mode change (Y-axis).
alarm.2143	Reference point return movement has been interrupted due to mode change (Z-axis).
alarm.2144	Reference point return movement has been interrupted due to mode change (4th-axis).
alarm.2145	Reference point return movement has been interrupted due to mode change (5th-axis).
alarm.2151	During the execution of reference point return, the deceleration LS is turned from OFF to ON before -phase latch is completed (X-axis).
alarm.2152	During the execution of reference point return, the deceleration LS is turned from OFF to ON before C-phase latch is completed (Y-axis).
alarm.2153	During the execution of reference point return, the deceleration LS is turned from OFF to ON before C-phase latch is completed (Z-axis).
alarm.2154	During the execution of reference point return, the deceleration LS is turned from OFF to ON before C-phase latch is completed (4th-axis).
alarm.2155	During the execution of reference point return, the deceleration LS is turned from OFF to ON before C-phase latch is completed (5th-axis).
alarm.2161	While an axis is disconnected, the disconnection input has been turned OFF (X-axis).

Alarm No.	Description
alarm.2162	While an axis is disconnected, the disconnection input has been turned OFF (Y-axis).
alarm.2163	While an axis is disconnected, the disconnection input has been turned OFF (Z-axis).
alarm.2164	While an axis is disconnected, the disconnection input has been turned OFF (4th-axis).
alarm.2165	While an axis is disconnected, the disconnection input has been turned OFF (5th-axis).
alarm.2171	Unmatch in axis disconnection status (X-axis).
alarm.2172	Unmatch in axis disconnection status (Y-axis).
alarm.2173	Unmatch in axis disconnection status (Z-axis).
alarm.2174	Unmatch in axis disconnection status (4th-axis).
alarm.2175	Unmatch in axis disconnection status (5th-axis).
alarm.2180	An axis been decelerated and stopped due to turning ON of the ERR 1 signal.
alarm.2190	The machine is not ready.
alarm.2191	The SLPC input signal has been turned off in the spindle command loop sequence by G93.
alarm.3000	Servo power is not turned on.
alarm.3001	The control is not ready.
alarm.3002	NC has entered the emergency stop state.
alarm.3010	The memory used to store machining programs has not been initialized.
alarm.3011	In initialization processing, expansion memory for storing machining programs and the memory after power on do not match.
alarm.3012	Axis configuration setting parameters do not agree with the physical axis configuration, or the option is not selected.
alarm.3013	YENET station number parameter setting error.
alarm.3014	The number of valid axes is greater than the allowable number.
alarm.3021	Fuse is blown (1st-axis).
alarm.3022	Fuse is blown (2nd-axis).
alarm.3023	Fuse is blown (3rd-axis).
alarm.3024	Fuse is blown (4th-axis).
alarm.3025	Fuse is blown (5th-axis).
alarm.3041	Excessively large servo error (1st-axis)
alarm.3042	Excessively large servo error (2nd-axis)

Alarm No.	Description
alarm.3043	Excessively large servo error (3rd-axis)
alarm.3044	Excessively large servo error (4th-axis)
alarm.3045	Excessively large servo error (5th-axis)
alarm.3051	Excessively large servo error (No.1 spindle)
alarm.3061	Overload (1st-axis)
alarm.3062	Overload (2nd-axis)
alarm.3063	Overload (3rd-axis)
alarm.3064	Overload (4th-axis)
alarm.3065	Overload (5th-axis)
alarm.3081	Disconnection in PG wiring (1st-axis)
alarm.3082	Disconnection in PG wiring (2nd-axis)
alarm.3083	Disconnection in PG wiring (3rd-axis)
alarm.3084	Disconnection in PG wiring (4th-axis)
alarm.3085	Disconnection in PG wiring (5th-axis)
alarm.3091	Disconnection in PG wiring (spindle)
alarm.3100	YENET1200 drive error has been detected.
alarm.3101	Servo pack error has occurred (1st-axis).
alarm.3102	Servo pack error has occurred (2nd-axis).
alarm.3103	Servo pack error has occurred (3rd-axis).
alarm.3104	Servo pack error has occurred (4th-axis).
alarm.3105	Servo pack error has occurred (5th-axis).
alarm.3111	Servo pack communication error has occurred (1st-axis).
alarm.3112	Servo pack communication error has occurred (2nd-axis).
alarm.3113	Servo pack communication error has occurred (3rd-axis).
alarm.3114	Servo pack communication error has occurred (4th-axis).
alarm.3115	Servo pack communication error has occurred (5th-axis).
alarm.3121	Over-speed has been detected (1st-axis).
alarm.3122	Over-speed has been detected (2nd-axis).
alarm.3123	Over-speed has been detected (3rd-axis).

Alarm No.	Description
alarm.3124	Over-speed has been detected (4th-axis).
alarm.3125	Over-speed has been detected (5th-axis).
alarm.3131	Serial communication error has occurred in the communication with the inverter (spindle).
alarm.3141	Runaway is detected with the servo controlled axis (1st-axis).
alarm.3142	Runaway is detected with the servo controlled axis (2nd-axis).
alarm.3143	Runaway is detected with the servo controlled axis (3rd-axis).
alarm.3144	Runaway is detected with the servo controlled axis (4th-axis).
alarm.3145	Runaway is detected with the servo controlled axis (5th-axis).
alarm.3151	Phase detection error has occurred (1st-axis).
alarm.3152	Phase detection error has occurred (2nd-axis).
alarm.3153	Phase detection error has occurred (3rd-axis).
alarm.3154	Phase detection error has occurred (4th-axis).
alarm.3155	Phase detection error has occurred (5th-axis).
alarm.3161	Malfunctioning is detected with the absolute position encoder (1st-axis).
alarm.3162	Malfunctioning is detected with the absolute position encoder (2nd-axis).
alarm.3163	Malfunctioning is detected with the absolute position encoder (3rd-axis).
alarm.3164	Malfunctioning is detected with the absolute position encoder (4th-axis).
alarm.3165	Malfunctioning is detected with the absolute position encoder (5th-axis).
alarm.3181	Malfunctioning is detected with the PG counter of the absolute position encoder (1st-axis).
alarm.3182	Malfunctioning is detected with the PG counter of the absolute position encoder (2nd-axis).
alarm.3183	Malfunctioning is detected with the PG counter of the absolute position encoder (3rd-axis).
alarm.3184	Malfunctioning is detected with the PG counter of the absolute position encoder (4th-axis).
alarm.3185	Malfunctioning is detected with the PG counter of the absolute position encoder (5th-axis).
alarm.3191	Error has occurred in the reduction of fraction of the gear ratio (1st-axis).
alarm.3192	Error has occurred in the reduction of fraction of the gear ratio (2nd-axis).
alarm.3193	Error has occurred in the reduction of fraction of the gear ratio (3rd-axis).
alarm.3194	Error has occurred in the reduction of fraction of the gear ratio (4th-axis).
alarm.3195	Error has occurred in the reduction of fraction of the gear ratio (5th-axis).
alarm.3221	Disconnection in wiring to the separately installed PG (1st-axis)

Alarm No.	Description
alarm.3222	Disconnection in wiring to the separately installed PG (2nd-axis)
alarm.3223	Disconnection in wiring to the separately installed PG (3rd-axis)
alarm.3224	Disconnection in wiring to the separately installed PG (4th-axis)
alarm.3225	Disconnection in wiring to the separately installed PG (5th-axis)
alarm.3240	Servo has been turned off due to turning ON of the ERR 2 signal.
alarm.3241	Absolute error (separately installed PG) has occurred (1st-axis).
alarm.3242	Absolute error (separately installed PG) has occurred (2nd-axis).
alarm.3243	Absolute error (separately installed PG) has occurred (3rd-axis).
alarm.3244	Absolute error (separately installed PG) has occurred (4th-axis).
alarm.3245	Absolute error (separately installed PG) has occurred (5th-axis).
alarm.3252	NMI interruption has occurred due to- the occurrence of bus gate error.
alarm.3253	NMI interruption has occurred due to- the occurrence of watchdog time-out.
alarm.3260	SH-INTEX synchronization error has occurred.
alarm.3261	SH-MOTION synchronization error has occurred.
alarm.3262	INTEX-MOTION synchronization error has occurred.
alarm.3263	MOTION-PLC synchronization error has occurred.
alarm.3264	MOTION-AXIS synchronization error has occurred.
alarm.3265	ACGC synchronization error has occurred.
alarm.3266	DNC synchronization error has occurred.
alarm.3270	Data error has occurred when turning the power OFF (battery backed-up memory).
alarm.3271	Data error has occurred when turning the power OFF (tool life control).
alarm.3272	Data error has occurred when turning the power OFF (macro).
alarm.3273	Data error has occurred when turning the power OFF (internal memory).
alarm.3274	Program has been destroyed due to turning the power off during editing (program).
alarm.3275	Data error has occurred when turning the power OFF during editing (custom variables).
alarm.3276	The power has been turned OFF during editing. This requires the program to be checked after turning the power ON.
alarm.3281	YENET1200 command time-out error has occurred (1st-axis).
alarm.3282	YENET1200 command time-out error has occurred (2nd-axis).

Alarm No.	Description
alarm.3283	YENET1200 command time-out error has occurred (3rd-axis).
alarm.3284	YENET1200 command time-out error has occurred (4th-axis).
alarm.3285	YENET1200 command time-out error has occurred (5th-axis).
alarm.3291	YENET1200 command time-out error has occurred (spindle).
alarm.3296	During sequence editing, the power is turned ON for the NC with the system number switch set in "0".
alarm.3297	Sequence data has been destroyed.
alarm.3299	Communication error has occurred in the YENET1200 (I/O).
alarm.3301	Excessively large current is supplied to the servo pack main circuit (1st-axis).
alarm.3302	Excessively large current is supplied to the servo pack main circuit (2nd-axis).
alarm.3303	Excessively large current is supplied to the servo pack main circuit (3rd-axis).
alarm.3304	Excessively large current is supplied to the servo pack main circuit (4th-axis).
alarm.3305	Excessively large current is supplied to the servo pack main circuit (5th-axis).
alarm.3311	Servo pack MCCB has been tripped (X-axis).
alarm.3312	Servo pack MCCB has been tripped (Y-axis).
alarm.3313	Servo pack MCCB has been tripped (Z-axis).
alarm.3314	Servo pack MCCB has been tripped (4th-axis).
alarm.3315	Servo pack MCCB has been tripped (5th-axis).
alarm.3321	An error has occurred with the servo pack regeneration resistor (X-axis).
alarm.3322	An error has occurred with the servo pack regeneration resistor (Y-axis).
alarm.3323	An error has occurred with the servo pack regeneration resistor (Z-axis).
alarm.3324	An error has occurred with the servo pack regeneration resistor (4th-axis).
alarm.3325	An error has occurred with the servo pack regeneration resistor (5th-axis).
alarm.3331	DC voltage in the servo pack main circuit is abnormally high (1st-axis).
alarm.3332	DC voltage in the servo pack main circuit is abnormally high (2nd-axis).
alarm.3333	DC voltage in the servo pack main circuit is abnormally high (3rd-axis).
alarm.3334	DC voltage in the servo pack main circuit is abnormally high (4th-axis).
alarm.3335	DC voltage in the servo pack main circuit is abnormally high (5th-axis).
alarm.3381	Communication error has occurred in the YENET 1200 (1st-axis).
alarm.3382	Communication error has occurred in the YENET 1200 (2nd-axis).

Alarm No.	Description
alarm.3383	Communication error has occurred in the YENET 1200 (3rd-axis).
alarm.3384	Communication error has occurred in the YENET 1200 (4th-axis).
alarm.3385	Communication error has occurred in the YENET 1200 (5th-axis).
alarm.3391	Communication error has occurred in the YENET 1200 (spindle).
alarm.3395	Converter error has occurred (spindle).
alarm.3401	Converter error has occurred (1st-axis).
alarm.3402	Converter error has occurred (2nd-axis).
alarm.3403	Converter error has occurred (3rd-axis).
alarm.3404	Converter error has occurred (4th-axis).
alarm.3405	Converter error has occurred (5th-axis).
alarm.3411	Servo unit error has occurred (1st-axis).
alarm.3412	Servo unit error has occurred (2nd-axis).
alarm.3413	Servo unit error has occurred (3rd-axis).
alarm.3414	Servo unit error has occurred (4th-axis).
alarm.3415	Servo unit error has occurred (5th-axis).
alarm.3421	Inverter unit error has occurred.
alarm.3425	Watchdog error has occurred in the YENET 1200 (spindle).
alarm.3431	Watchdog error has occurred in the YENET 1200 (1st-axis).
alarm.3432	Watchdog error has occurred in the YENET 1200 (2nd-axis).
alarm.3433	Watchdog error has occurred in the YENET 1200 (3rd-axis).
alarm.3434	Watchdog error has occurred in the YENET 1200 (4th-axis).
alarm.3435	Watchdog error has occurred in the YENET 1200 (5th-axis).
alarm.3441	Ground fault (1st-axis)
alarm.3442	Ground fault (2nd-axis)
alarm.3443	Ground fault (3rd-axis)
alarm.3444	Ground fault (4th-axis)
alarm.3445	Ground fault (5th-axis)
alarm.3451	Follow-up error has occurred (1st-axis).
alarm.3452	Follow-up error has occurred (2nd-axis).

Alarm No.	Description
alarm.3453	Follow-up error has occurred (3rd-axis).
alarm.3454	Follow-up error has occurred (4th-axis).
alarm.3455	Follow-up error has occurred (5th-axis).
alarm.3461	Erroneous setting of the motor code (1st-axis)
alarm.3462	Erroneous setting of the motor code (2nd-axis)
alarm.3463	Erroneous setting of the motor code (3rd-axis)
alarm.3464	Erroneous setting of the motor code (4th-axis)
alarm.3465	Erroneous setting of the motor code (5th-axis)

2.3 TROUBLESHOOTING

Alarm No. : 1098 Fan is Faulty

ALARM CAUSE	CHECK ITEM	COUNTER MEASURE
Fan is faulty.	Check fan. Ensure connections are good. Check for obstruction.	If the fan is faulty, replace it. Contact your Yaskawa representative.

Alarm No. : 1099 High Temperature

ALARM CAUSE	CHECK ITEM	COUNTER MEASURE
<p>Ambient temperature of the NC rack exceeded the specified value* due to cooling fan failure.</p> <p>* : 70 degC +/- 3 degC</p> <p>When measured above CPS-18</p>	<p>Open NC door and check that the cooling fan motor is operating.</p> <p>Make sure that air is blowing out through the ventilation port of the cooling duct.</p> <p>Check to make sure ventilation port of cooling duct is not obstructed.</p>	<p>If the fan is faulty, replace it. Contact your Yaskawa representative.</p> <p>If cooling fan is block remove obstruction.</p>
Internal temperature of the power supply unit is high.	Allow the power supply unit to cool by turning OFF the power with the NC unit door opened. If the alarm occurs even after the power supply unit has been cooled for 30 minutes, the power supply unit is faulty.	Change the power supply unit. Contact your Yaskawa representative.
<p>Ambient temperature of the NC unit is high.*</p> <p>* Allowable temperature range for 'operation is 0 - 40 degC.</p>	<p>Measure ambient temperature.</p> <p>If the NC unit is subject to direct sunlight, the NC unit temperature will exceed the allowable limit.</p>	<p>This is not the failure of the NC unit.</p> <p>Remove the cause.</p>

Alarm No. : 2061 to 2068 (Reference point return Error)

ALARM CAUSE	CHECK ITEM	COUNTER MEASURE
The reference point return start point is at the zero oint side of the deceleration limit switch.	If reference point return is started from a point located at the reference point side of DECLS an alarm occurs #3073 D0 (1st Axis) #3073 D1 (2nd Axis) #3073 D2 (3rd Axis) #3073 D3 (4th Axis) #3073 D4 (5th Axis)	Return the axis to a position on the DECLS side or away from it, then execute reference point return again.
Approach feedrate is too fast.	Compare the setting for the approach feedrate parameter with the parameter list.	Change the setting for parameters pm2521 to pm2525 to an appropriate value.

Alarm No. : 2071 to 2078, 2081 to 2088 (Reference point return Error)

ALARM CAUSE	CHECK ITEM	COUNTER MEASURE
Alarm in manual reference point return operation.	Check if errors occurs every time.	Contact your machine tool builder or Yaskawa representative.
Alarm in automatic reference point return operation.	G28: Check if alarm occurs every time.	Contact your machine tool builder or Yaskawa representative.
	G27: Check the point specified in the program if it agrees with the zero point.	Review the program

Alarm No. : 3000 (Servo Power Not Ready)

ALARM CAUSE	CHECK ITEM	COUNTER MEASURE
Secondary power supply is not applied	If the NC RESET switch, etc. is depressed after depressing the POWER ON button once, or after clearing the emergency stop or alarm state, the alarm message is displayed. This does not indicate occurrence of alarm.	Press the POWER ON button again.
With the secondary power ON I/O input specification, the input is not turned ON. (For the automatic servo power ON)	Check the following on the I/O monitor screen: #3005 D0 = 1 (SVON) #3503 D0 = 1 (SVONS)	Contact your Yaskawa representative.

Alarm No. : 3001 (Control Not Ready)

The NC executes self-diagnosis after power ON. If positioning error checked during this self-diagnosis exceeds the values set for parameters pm1321 (1st Axis) to pm1325 (5th Axis), this alarms occurs.

ALARM CAUSE	CHECK ITEM	COUNTER MEASURE
Machine (axes) have moved.	Select the error pulse display screen from the present position display screen in the common process and check the error pulse value.	The machine tool has a problem. Contact the machine tool builder.
PG signal remains output.		PG or AC servo must be changed. Contact your Yaskawa representative.

Alarm No. : 3041 to 3048 (Excessive Follow-up Error)

If the follow-up error between the command value and the actual position value exceeds 120% of the error in rapid traverse (100%) operation, this alarm occurs. Check the values set for parameters pm1671 to pm1675 and pm1681 to pm1685 and contact the machine tool builder or your Yaskawa representative.

Alarm No. : 3051 (Excessive Follow-up Error: Spindle)

If the follow-up error between the command value and the actual position value exceeds the value set for parameter pm1351, this alarm occurs. Check the value set for parameter pm1351 and contact the machine tool builder or your Yaskawa representative.

Alarm No. : 3061 to 3068 (overload)

ALARM CAUSE	CHECK ITEM	COUNTER MEASURE
Cutting Conditions	Check if the alarm occurred during machining.	Turn OFF the power and allow the servo motors to cool. After cooling change the machining conditions and restart operation.
Guideways are not lubricated properly causing heavy axis movements.	If guideways are lubricated check for damage or obstructions.	Contact the machine tool builder or your Yaskawa representative.

Alarm No. : 3081 to 3088 (Broken PG Cable)

ALARM CAUSE	CHECK ITEM	COUNTER MEASURE
Signal cables between the NC and the AC servo drive unit are broken or loose.	Check cable and connectors.	If cable is damaged replace. Check to make sure connectors are plugged in securely.
Faulty PG cable breakage detection circuit.	Check if the alarm occurs when you first POWER ON even if the cables are connected properly.	Contact your Yaskawa representative.
Error in motor type parameter setting.	Check the motor type setting parameters (pm1061 to pm1065) if "0" has been set.	Correct the setting.

Alarm No. : 3091 (Broken Spindle PG Cable)

ALARM CAUSE	CHECK ITEM	COUNTER MEASURE
Signal cables between the NC and the AC servo drive unit are damaged or loose.	Check cable and connectors.	If cable is damaged replace. Check to make sure connectors are plugged in securely.

Faulty PG cable breakage detection circuit.	Check if the alarm occurs when you first POWER ON even if the cables are connected properly.	Contact your Yaskawa representative.
Faulty PG	If alarm occurs during low speed operation the PG could be faulty.	Get a new PG. Contact your Yaskawa representative.

Alarm No. : 3121 to 3125 (excessive Speed)

The alarm is detected if the motor speed exceeds 1.2 times the maximum motor speed. Contact your Yaskawa representative.

Alarm No. : 3161 to 3165 (Absolute Error)

Malfunction of the absolute encoder is detected. Contact your Yaskawa representative after checking the following :

1. Whether the alarm occurs immediately after the control power is turned ON.
2. Whether the alarm is cleared when the power is turned OFF and then turned ON again.
3. Whether the battery alarm occurs at the same time.

Alarm No. : 3181 to 3185 (Position Error)

Malfunction of the PG pulse counter in the absolute encoder is detected. Contact your Yaskawa representative after checking the following :

1. Whether the alarm occurs immediately after the control power is turned ON.
2. Whether the alarm occurs frequently during operation.

Alarm No. : 3201 to 3205 (Servo drive Communications Error)

Communication error between the NC and the AC servodrive unit is detected. Contact your yaskawa representative.

Alarm No. : 3301 to 3305 (Over Current)

Contact your Yaskawa representative after checking the following :

1. Whether the alarm occurs immediately after the control power in turned ON.
2. Whether the alarm occurs after turning ON the main power.

Alarm No. : 3311 to 3315 (MCCB Trip)

Contact your Yaskawa representative after checking the following :

1. Whether the alarm occurs immediately after the control power is turned ON.
2. Whether the alarm occurs after turing ON the main power.

Alarm No. : 3321 to 3325 (Regeneration Error)

Contact your Yaskawa representative after the following :

1. Whether the alarm occurs immediately after the control power is turned ON.
2. Whether the alarm occurs after turning ON the man power.

Alarm No. : 3331 - 3335 (Over Voltage)

Contact your Yaskawa representative after the following :

1. Whether the alarm occurs at the start of motor rotation.
2. Whether the alarm occurs during deceleration.

Alarm No. : 3341 to 3345 (Under Voltage)

Contact your Yaskawa representative after the following :

1. Whether the alrm occus after turning ON the main power.

Alarm No. : 3351 to 3355 (Under Voltage)

ALARM CAUSE	CHECK ITEM	COUNTER MEASURE
Faulty control board	Check whether the alarm occurs immediately after the control power is turned ON.	Contact your Yaskawa representative.
Fan Stop	1. Check whether the alarms occurs during operation. The alarm reoccurs if the control power is turned ON after turning it OFF once, or the operation restarts when the NC is reset after several minutes. 2. Check to see if the fan is rotating	Contact your Yaskawa representative.

Alarm No. : 3361 to 3365 (Wire break in current instruction cable)

Contact your Yaskawa representative after checking the following :

1. Whether the alarm occurs immediately after the control power is turned ON.
2. Whether an alarm other than current instruction cable breakage occurs.

Alarm No.: 3371 to 3375 (Open Phase Detection)

Contact your Yaskawa representative after checking the following :

1. Whether the alarm occurs immediately after the control power is turned ON.
2. Whether an alarm occurs after turning ON the main power.

Alarm No. : 3021 to 3025 (Fuse Blown)

1. The Main circuit of the servo unit is faulty.
2. The servo unit detects an error.
3. Contact your Yaskawa representative.

Alarm No. : 3101 - 3105 (Servo Alarm)

1. This alarm occurs when the NC unit detects the alarm signal output from the servo unit.

Alarm No. : 3111 to 3115 (Servo Communication Alarm)

1. Probable causes of this alarm are broken YENET1200 communication cable, loose cable connection, and communication processing error.
2. The servo unit detects the alarm.
3. Contact your Yaskawa representative after making sure the cable is securely connected.

Alarm No. : 3141 to 3145 (Overrun Prevention)

1. The encoder is faulty.
2. The servo unit detects the alarm.
3. Contact your Yaskawa representative.

Alarm No. : 3151 to 3155 (Phase Detection Error)

1. The encoder signal cable or the encoder itself is faulty.
2. The servo unit detects an error.
3. Contact your Yaskawa representative.

Alarm Nos. : 3151 to 3155(Phase Detection Error)

1. The encoder signal cable or the encoder itself is faulty.
2. The servo unit detects the error.
3. Contact your Yaskawa representative.

Alarm Nos.: 3181 to 3185 (Absolute Position Error)

1. The number of feedback pulses is checked every turn of the encoder and this alarm occurs if there is an error in the counted number of pulses.
2. The servo unit detects the alarm.
3. The encoder or the servo unit will be faulty, or malfunction could have occurred due to noises.
4. Contact your Yaskawa representative.

Alarm No.: 3201 (Inverter Alarm)

1. This alarm occurs when the NC unit detects the alarm signal output from the inverter.
2. Check the contents of the alarm by displaying the servo alarm display screen (press [F2] of the alarm job in the common process.).

Alarm Nos.: 3281 to 3285, 3291 (YENET1 200 command time-out)

1. This alarm occurs when the YENET1200 communication lines fail to get ready.
2. The NC units detects the alarm.
3. The servo unit or the inverter unit is faulty.
4. Contact your Yaskawa representative.

Alarm Nos.: 3301 to 3305 (Over Current)

1. The servo unit detects the alarm.
2. The servo unit will be faulty if the alarm occurs before the operation is started after turning the power ON,
3. If the alarm occurs during operation, ground fault of the motor is the cause.
4. Contact your Yaskawa representative.

Alarm Nos.: 3331 to 3335 (Over Voltage)

1. The servo unit detects the alarm.
2. If the alarm occurs when the power is turned ON to the spindle, the input voltage is too high.
3. If the alarm occurs during motor operation, it is necessary to review the operation conditions; lower motor speed, for example.
4. If the alarm occurs when the servo control power is turned ON, the servo unit is faulty.
5. Contact your Yaskawa representative.

Alarm Nos.: 3351 to 3355 (Heat Sink Overheat)

1. This alarm occurs when the heat sink temperature is abnormally high.
2. The servo unit detects the alarm.
3. If this alarm occurs, turn OFF the power and allow the heat sink to cool. After that, turn the power ON again.
4. If the alarm occurs immediately after turning the power ON, the servo unit is faulty.
5. Contact your Yaskawa representative.

Alarm Nos.: 3381 to 3385,3391 (YENET1200 Communication Error)

1. This is an communication error between the NC unit and the servo unit or between the NC unit and the inverter unit; the NC unit detects the alarm when no answer is returned for the command output by the NC unit.
2. The servo unit or the inverter unit is faulty, or the cable will not be connected securely.
3. Contact your Yaskawa representative.

Alarm Nos.: 3401 to 3405 (Converter Alarm)

1. This alarm occurs due to the following reasons: blown fuse, regeneration alarm, open phase, or faulty board.
2. The servo unit detects the alarm.
3. Contact your Yaskawa representative.

Alarm Nos.: 3411 to 3415 (Servo Unit Alarm)

1. This alarm occurs due to the following reasons: destroyed parameter setting, faulty current detector, encoder's battery alarm, memory error or sensor error.
2. The servo unit detects the alarm.
3. The servo unit or the motor is faulty.
4. Contact your Yaskawa representative.

Alarm No.: 3421 (Inverter Unit Alarm)

1. This alarm occurs when the inverter detects an alarm other than converter alarm, broken PG cable, excessive follow-up error, and communication error.
2. Contact your Yaskawa representative.

Alarm Nos.: 3425, 3431 to 34(35 (YENET1 200 Watchdog Error)

1. This alarm occurs when the NC unit detects the watchdog error with the inverter unit or the servo unit.
2. The inverter unit or the servo unit is faulty.
3. Contact your Yaskawa representative.

Alarm Nos.: 3441 to 3445 (Ground Fault)

1. This alarm occurs when the servo unit detects the alarm when the power is turned ON.
2. Motor insulation is faulty.
3. Contact your Yaskawa representative.

Alarm No.: 3451 and 3452 (Follow-up Error)

1. This alarm occurs when the follow-up error exceeds the value set for the servo unit parameter.
2. The servo unit detects the alarm.
3. If this alarm occurs during axis feed over a long distance, it is necessary to either lower the command speed or increase the gain.
4. If the motor does not rotate, the servo unit is faulty.

Appendix **3**

Parameter Tables

This appendix contains the parameter tables.

1st Axis	A3-3
2nd Axis.....	A3-8
3rd Axis.....	A3-13
4th Axis.....	A3-18
5th Axis.....	A3-23
Absolute Encoder	A3-28
Advanced Axis	A3-31
Auxiliary Axis.....	A3-36
Auxiliary Function.....	A3-38
Backlash.....	A3-39
Basic	A3-40
Canned Cycle.....	A3-43
Configuration.....	A3-44
Contour Compensation	A3-47
Data In/Out	A3-48
Feed.....	A3-49
F1 Digit	A3-50
G Code.....	A3-51
Handle	A3-53
High Speed Cutting.....	A3-54
I/O	A3-55
Jog.....	A3-60
Linear Scale.....	A3-61
Machine Setup.....	A3-64
Macro Program	A3-101
Parameter Measurement	A3-105

Motion	A3-108
NC System.....	A3-109
Operation	A3-113
Pitch Error	A3-116
Programming	A3-119
Rapid	A3-122
Reduced Vibration when Stopped	A3-125
Reference Point Return	A3-126
Roundness Irregularity	A3-131
Screen	A3-133
Servo	A3-134
Servo Damping Control.....	A3-156
Skip	A3-158
Software Switch.....	A3-161
Solid Tap	A3-162
Spindle.....	A3-165
Spindle Index.....	A3-167
Stroke Limit.....	A3-168
System	A3-171
Tool Coordinate.....	A3-172
Tool Life	A3-173
Tool Magazine	A3-174
Toolwork Coordinate.....	A3-175
Tooling.....	A3-176
Torque Limit	A3-177

Variable In PositionA3-179

Work CoordinateA3-180

1st Axis

Address	Bit	Description	Register Units	Minimum Value	Maximum Value	Long Description
1020	0	1st axis YENET station number		0	15	1st Physical servo axis YENET1200 station number setting (No. 2 to No. 15 station)
	5	1st axis debug mode		0	1	
	6	1st axis Physical servo axis specifications		0	1	
	7	1st axis Physical servo axis enable		0	1	
1030	0	1st axis Velocity loop control method		0	1	
	1	1st axis Velocity loop control automatic		0	1	
	6	1st axis Axis type		0	1	
	7	1st axis Servo Motor rotation direction		0	1	
1044	0	1st axis Servo feed amount change		0	1	
	1	1st axis Absolute encoder		0	1	
	2	1st axis Disregarding error pulse at emergency stop		0	1	
	3	1st axis Follow-up processing for servo OFF		0	1	
	4	1st axis Use of absolute encoder		0	1	
	5	1st axis Zero return Virtual C phase motor 1 rev		0	1	
	6	1st axis Infinite length for rotary axis control		0	1	
	7	1st axis Use of 17-bit encoder		0	1	
1061	0	Setting of motor selection code for 1st axis		0	255	
1070	0	External torque observer 1st axis		0	1	Availability of digital amplifier offset external torque observer
1071	0	1st axis motor encoder type		0	255	
1080	0	1st axis roundness irregularity compensation		0	1	
1081	0	1st axis Externally installed encoder type		0	255	
1096	0	1st axis Servo Damping control		0	1	
1097	0	1st axis Reduced vibration when servo stop		0	1	
1100		1st Servo axis display name	ascii	0	255	

Address	Bit	Description	Register Units	Minimum Value	Maximum Value	Long Description
1142		1st Servo axis automatic system axis name	ascii	0	255	
1321		1st axis Error detect-ON area	0.001mm	0	255	
1371		1st axis Reduced vibration level when servo stop	%	0	100	
1551		1st axis backlash compensation amount	0.1micron	0	32767	
1561		1st axis No of teeth of monitor when servo feed change	tooth	1	255	
1571		1st axis No of teeth of screw side when servo feed change	tooth	0	255	
1580		1st axis Position loop gain Kp	0.01[1/S]	500	20000	
1581		1st axis Velocity loop gain Kv	0.1[1/S]	350	32767	
1582		1st axis Speed loop integration time constant	0.01msec	26	32767	
1583		1st axis Second position loop gain Kp	0.01[1/S]	500	20000	
1584		1st axis Speed feed forward gain Kvfff	%	0	100	
1585		1st axis Second velocity loop gain Kv	0.1[1/S]	350	32767	
1586		1st axis First step axis torsion filter time constant Tn	0.01msec	1	32767	
1587		1st axis Second step axis torsion filter time constant Tn	0.01msec	1	32767	
1588		1st axis Third step axis torsion filter time	0.01msec	1	32767	
1589		1st axis Monitor board signal selection, multiplication		0	32767	
1641		1st axis Variable in position check No1 area	0.001mm	0	32767	
1651		1st axis Variable in position check No2 area	0.001mm	0	32767	For caned cycle and solid tap
1671		1st axis torque limit value (+)	%	1	32767	
1681		1st axis Servo Damping, observer time constant	Hz	0	32767	
1701		1st axis Servo Damping, load inertia fine	%	0	10000	
1711		1st axis backlash time constant	0.01msec	0	32767	
1751		1st axis Servo Damping, high pass filter time const	micro sec	0	32767	
1781		1st axis contour compensation 2nd coefficient	0.001times	0	32767	
1791		1st axis Servo Damping, low pass filter time const	micro sec	0	32767	

Address	Bit	Description	Register Units	Minimum Value	Maximum Value	Long Description
1801		1st axis contour compensation coefficient	0.001times	0	32767	
1811		1st axis Servo Damping, compensation gain	%	-2000	2000	
1821		1st axis Motion amount or table rotation angle/motor rev	0.001mm	0	999999999	
1831		1st axis load inertia	%	0	32767	
1841		1st axis separately PG, No. of pulses / motor rev	pulse	0	999999999	
1851		1st axis Virtual C phase distance	0.001deg	0	999999999	
2002	0	1st axis validity of automatic mode handle offset		0	1	
2461		1st axis rapid feed accel/decel time constant	msec	0	32767	Set multiple of 4
2481		1st axis backlash compensation amount in G01 mode	0.1micron	-32767	32767	
2491		1st axis backlash compensation amount in Handle	0.1micron	-32767	32767	
2501		1st axis accel/decel time constant in feed	msec	0	32767	
2511		1st axis accel/decel time constant in thread/tap	msec	0	32767	
2521		1st axis reference point return approach speed	mm/min, deg/min	0	32767	
2531		1st axis reference point return creep speed	mm/min, deg/min	0	32767	
2561		1st axis accel/decel time constant in handle feed	msec	0	32767	Set multiple of 4
2571		1st axis accel/decel time constnat in No2 G00 mode	msec	0	32767	Set multiple of 4
2591		1st axis rapid feed accel/decel S-curve		0	20	
2601		1st axis rapid feed accel/decel S-curve in 2nd S		0	15	
2801		1st axis Rapid feed rate	mm/min	0	240000	
2811		1st axis rapid feed rate in 2nd S-curve accel/dece	mm/min, deg/min	0	240000	
2821		1st axis bias in normal cutting accel/decel	mm/min, deg/min	0	240000	
2831		1st axis bias in thread cutting accel/decel	mm/min, deg/min	0	240000	
2851		1st axis second G00 feedrate	mm/min, deg/min	0	240000	

Address	Bit	Description	Register Units	Minimum Value	Maximum Value	Long Description
4002	0	1st axis Reference point return direction		0	1	
4004	0	Alarm occur if axis move command before ZRN 1st axis		0	1	Occurrence of alarm if movement command other than G28 is executed without carrying out manual or automatic reference point return for 1st axis
4006	0	1st axis Automatic coordinate system setting		0	1	
4014	0	1st axis Direction of G60 unidirectional positioning		0	1	
4022	0	1st axis validity of reference point return		0	1	
4024	0	1st axis validity of playback write		0	1	
4451		1st axis reference point return traverse distance	0.001mm	0	32767	
4461		1st axis overtravel distance in G60	0.001mm	0	32767	
4551		Virtual C-phase shift distance 1st axis	0.001mm	-32767	32767	
4801		1st axis automatic coordinate setup value when mm	0.001mm	-999999999	999999999	
4811		1st axis automatic coordinate setup value when inch	0.0001inch	-393700787	393700787	
5015	0	1st axis PLC control axis switch over		0	1	
5101		1st axis PLC axis control group		0	3	
5401		Time from ESP signal rising to base block on 1st axis	msec	0	32767	multiply of 10msec
6000	0	Pitch error compensation 1st axis		0	1	
6002	0	No.1 stored stroke limit check 1st axis execution		0	1	
6004	0	Execution of stored stroke limit check for rotary 1st axis		0	1	
6006	0	Axis disconnection 1st axis		0	1	
6101		1st axis, pitch error compensation multiplication		0	3	
6401		1st axis, pitch error start memory number		0	1151	
6411		1st axis, pitch error completion memory		0	1151	
6421		1st axis, pitch error reference point memory number		0	1151	
6801		1st axis, pitch error compensation intervals	0.001mm	0	999999999	

Address	Bit	Description	Register Units	Minimum Value	Maximum Value	Long Description
6811		1st axis, second reference point position	0.001mm	-999999999	999999999	
6821		1st axis, third reference point position	0.001mm	-999999999	999999999	
6831		1st axis, fourth reference point position	0.001mm	-999999999	999999999	
6861		1st axis, pitch error compensation stroke	0.001mm	-999999999	999999999	
6871		1st axis, pitch error compensation stroke (minimum)	0.001mm	-999999999	999999999	
6881		1st axis, pitch error comp reference point position	0.001mm	-999999999	999999999	
6901		No.1 stored stroke limit 1st axis (+)	0.001mm	-999999999	999999999	
6911		No.1 stored stroke limit 1st axis (-)	0.001mm	-999999999	999999999	
8000	0	Absolute motor zero return condition 1st axis		0	1	
8001	0	Absolute motor position gap condition 1st		0	1	
8401		1st axis, fine adjust amount in zero point setting		-32767	32767	
8411		1st axis, position gap distance limit when power ON		0	32767	
8471		1st axis (- to +) roundness irregularity Integral constant	msec	0	32767	
8481		1st axis (- to +) roundness irregularity completion torque	0.01%	0	20000	
8491		1st axis roundness irregularity Timing parameter	0.01[1/S]	-32767	32767	
8521		1st axis roundness irregularity weight compensation torque	0.01%	-12000	12000	
8801		1st axis, power off machine position	0.001mm	-999999999	999999999	
8811		1st axis, offset amount in zero point setting	pulse	-999999999	999999999	
8821		1st axis, shift amount in zero point setting	0.001mm	-999999999	999999999	

2nd Axis

Address	Bit	Description	Register Units	Minimum Value	Maximum Value	Long Description
1021	0	2nd axis YENET station number		0	15	2nd Physical servo axis YENET1200 station number setting (No. 2 to No. 15 station)
	5	2nd axis debug mode		0	1	
	6	2nd axis Physical servo axis specifications		0	1	
	7	2nd axis Physical servo axis enable		0	1	
1031	0	2nd axis Velocity loop control method		0	1	
	1	2nd axis Velocity loop control automatic		0	1	
	6	2nd axis Axis type		0	1	
	7	2nd axis Servo Motor rotation direction		0	1	
1045	0	2nd axis Servo feed amount change		0	1	
	1	2nd axis Absolute encoder		0	1	
	2	2nd axis Disregarding error pulse at emergency stop		0	1	
	3	2nd axis Follow-up processing for servo OFF		0	1	
	4	2nd axis Use of absolute encoder		0	1	
	5	2nd axis Zero return Virtual C phase motor 1rev		0	1	
	6	2nd axis Infinite length for rotary axis control		0	1	
	7	2nd axis Use of 17-bit encoder		0	1	
1062	0	Setting of motor selection code for 2nd axis		0	255	
1070	1	External torque observer 2nd axis		0	1	Availability of digital amplifier offset external torque observer
1072	0	2nd axis motor encoder type		0	255	
1080	1	2nd axis roundness irregularity compensation		0	1	
1082	0	2nd axis Externally installed encoder type		0	255	
1096	1	2nd axis Servo Damping control		0	1	
1097	1	2nd axis Reduced vibration when servo stop		0	1	
1103		2nd Servo axis display name	ascii	0	255	

Address	Bit	Description	Register Units	Minimum Value	Maximum Value	Long Description
1145		2nd Servo axis automatic system axis name	ascii	0	255	
1322		2nd axis Error detect-ON area	0.001mm	0	255	
1372		2nd axis Reduced vibration level when servo stop	%	0	100	
1552		2nd axis backlash compensation amount	0.1micron	0	32767	
1562		2nd axis No of teeth of monitor when servo feed change	tooth	0	255	
1572		2nd axis No of teeth of screw side when servo feed change	tooth	0	255	
1590		2nd axis Position loop gain Kp	0.01[1/S]	500	20000	
1591		2nd axis Velocity loop gain Kv	0.1[1/S]	350	32767	
1592		2nd axis Speed loop integration time constant Ti	0.01msec	26	32767	
1593		2nd axis Second position loop gain Kp	0.01[1/S]	500	20000	
1594		2nd axis Speed feed forward gain Kvfff	%	0	100	
1595		2nd axis Second velocity loop gain Kv	0.1[1/S]	350	32767	
1596		2nd axis First step axis torsion filter time constant Tn	0.01msec	1	32767	
1597		2nd axis Second step axis torsion filter time	0.01msec	1	32767	
1598		2nd axis Third step axis torsion filter time constant Tn	0.01msec	1	32767	
1599		2nd axis Monitor board signal selection, multiplication		0	32767	
1642		2nd axis Variable in position check No1 area	0.001mm	0	32767	
1652		2nd axis Variable in position check No2 area	0.001mm	0	32767	For caned cycle and solid tap
1672		2nd axis torque limit value (+)	%	0	32767	
1682		2nd axis Servo Damping, observer time	Hz	0	32767	
1702		2nd axis Servo Damping, load inertia fine adjust	%	0	10000	
1712		2nd axis backlash time constant	0.01msec	0	32767	
1752		2nd axis Servo Damping, high pass filter time const	micro sec	0	32767	
1782		2nd axis contour compensation 2nd coefficient	0.001times	0	32767	

Address	Bit	Description	Register Units	Minimum Value	Maximum Value	Long Description
1792		2nd axis Servo Damping, low pass filter time const	micro sec	0	32767	
1802		2nd axis contour compensation coefficient	0.001times	0	32767	
1812		2nd axis Servo Damping, compensation gain	%	-2000	2000	
1822		2nd axis Motion amount or table rotation angle/motor rev	0.001mm	0	999999999	
1832		2nd axis load inertia	%	0	32767	
1842		2nd axis separately PG, No. of pulses / motor rev	pulse	0	999999999	
1852		2nd axis Virtual C phase distance	0.001deg	0	999999999	
2002	1	2nd axis validity of automatic mode handle offset		0	1	
2462		2nd axis rapid feed accel/decel time constant	msec	0	32767	Set multiple of 4
2482		2nd axis backlash compensation amount in G01 mode	0.1micron	-32767	32767	
2492		2nd axis backlash compensation amount in	0.1micron	-32767	32767	
2502		2nd axis accel/decel time constant in feed cut	msec	0	32767	
2512		2nd axis accel/decel time constant in thread/tap	msec	0	32767	
2522		2nd axis reference point return approach speed	mm/min, deg/min	0	32767	
2532		2nd axis reference point return creep speed	mm/min, deg/min	0	32767	
2562		2nd axis accel/decel time constant in handle feed	msec	0	32767	Set multiple of 4
2572		2nd axis accel/decel time constant in No2 G00	msec	0	32767	Set multiple of 4
2592		2nd axis rapid feed accel/decel S-curve		0	20	
2602		2nd axis rapid feed accel/decel S-curve in 2nd S		0	15	
2802		2nd axis Rapid feed rate	mm/min	0	240000	
2812		2nd axis rapid feed rate in 2nd S-curve accel/dece	mm/min, deg/min	0	240000	
2822		2nd axis bias in normal cutting accel/decel	mm/min, deg/min	0	240000	
2832		2nd axis bias in thread cutting accel/decel	mm/min, deg/min	0	240000	

Address	Bit	Description	Register Units	Minimum Value	Maximum Value	Long Description
2852		2nd axis second G00 feedrate	mm/min, deg/min	0	240000	
4002	1	2nd axis Reference point return direction		0	1	
4004	1	Alarm occur if axis move command before ZRN 2nd axis		0	1	Occurrence of alarm if movement command other than G28 is executed without carrying out manual or automatic reference point return for 2nd axis
4006	1	2nd axis Automatic coordinate system setting		0	1	
4014	1	2nd axis Direction of G60 unidirectional positioning		0	1	
4022	1	2nd axis validity of reference point return		0	1	
4024	1	2nd axis validity of playback write		0	1	
4452		2nd axis reference point return traverse distance	0.001mm	0	32767	
4462		2nd axis overtravel distance in G60	0.001mm	0	32767	
4552		Virtual C-phase shift distance 2nd axis	0.001mm	-32767	32767	
4802		2nd axis automatic coordinate setup value when mm	0.001mm	-999999999	999999999	
4812		2nd axis automatic coordinate setup value when inch	0.0001inch	-393700787	393700787	
5015	1	2nd axis PLC control axis switch over		0	1	
5102		2nd axis PLC axis control group		0	3	
5402		Time from ESP signal rising to base block ON	msec	0	32767	multiply of 10msec
6000	1	Pitch error compensation 2nd axis		0	1	
6002	1	No.1 stored stroke limit check 2nd axis execution		0	1	
6004	1	Execution of stored stroke limit check for rotary 2nd axis		0	1	
6006	1	Axis disconnection 2nd axis		0	1	
6102		2nd axis, pitch error compensation multiplication		0	3	
6402		2nd axis, pitch error start memory number		0	1151	
6412		2nd axis, pitch error completion memory number		0	1151	

Address	Bit	Description	Register Units	Minimum Value	Maximum Value	Long Description
6422		2nd axis, pitch error reference point memory number		0	1151	
6802		2nd axis, pitch error compensation intervals	0.001mm	0	99999999	
6812		2nd axis, second reference point position	0.001mm	-99999999	99999999	
6822		2nd axis, third reference point position	0.001mm	-99999999	99999999	
6832		2nd axis, fourth reference point position	0.001mm	-99999999	99999999	
6862		2nd axis, pitch error compensation stroke (maximum)	0.001mm	-99999999	99999999	
6872		2nd axis, pitch error compensation stroke (minimum)	0.001mm	-99999999	99999999	
6882		2nd axis, pitch error comp reference point position	0.001mm	-99999999	99999999	
6902		No.1 stored stroke limit 2nd axis (+)	0.001mm	-99999999	99999999	
6912		No.1 stored stroke limit 2nd axis (-)	0.001mm	-99999999	99999999	
8000	1	Absolute motor zero return condition 2nd axis		0	1	
8001	1	Absolute motor position gap condition 2nd axis		0	1	
8402		2nd axis, fine adjust amount in zero point setting		-32767	32767	
8412		2nd axis, position gap distance limit when ???		0	32767	
8472		2nd axis (- to +) roundness irregularity Integral constant	msec	0	32767	
8482		2nd axis (- to +) roundness irregularity completion torque	0.01%	0	20000	
8492		2nd axis roundness irregularity Timing parameter	0.01[1/S]	-32767	32767	
8522		2nd axis roundness irregularity weight compensation torque	0.01%	-12000	12000	
8802		2nd axis, power off machine position	0.001mm	-99999999	99999999	
8812		2nd axis, offset amount in zero point setting	pulse	-99999999	99999999	
8822		2nd axis, shift amount in zero point setting	0.001mm	-99999999	99999999	

3rd Axis

Address	Bit	Description	Register Units	Minimum Value	Maximum Value	Long Description
1022	0	3rd axis YENET station number		0	15	3rd Physical servo axis YENET1200 station number setting (No. 2 to No. 15 station)
	5	3rd axis debug mode		0	1	
	6	3rd axis Physical servo axis specifications		0	1	
	7	3rd axis Physical servo axis enable		0	1	
1032	0	3rd axis Velocity loop control method		0	1	
	1	3rd axis Velocity loop control automatic setting		0	1	
	6	3rd axis Axis type		0	1	
	7	3rd axis Servo Motor rotation direction		0	1	
1046	0	3rd axis Servo feed amount change		0	1	
	1	3rd axis Absolute encoder		0	1	
	2	3rd axis Disregarding error pulse at emergency		0	1	
	3	3rd axis Follow-up processing for servo OFF		0	1	
	4	3rd axis Use of absolute encoder		0	1	
	5	3rd axis Zero return Virtual C phase motor 1		0	1	
1046	6	3rd axis Infinite length for rotary axis control		0	1	
	7	3rd axis Use of 17-bit encoder		0	1	
1063	0	Setting of motor selection code for 3rd axis		0	255	
1070	2	External torque observer 3rd axis		0	1	Availability of digital amplifier offset external torque observer
1073	0	3rd axis motor encoder type		0	255	
1080	2	3rd axis roundness irregularity compensation		0	1	
1083	0	3rd axis Externally installed encoder type		0	255	
1096	2	3rd axis Servo Damping control		0	1	
1097	2	3rd axis Reduced vibration when servo stop		0	1	
1106		3rd Servo axis display name	ascii	0	255	

Address	Bit	Description	Register Units	Minimum Value	Maximum Value	Long Description
1148		3rd Servo axis automatic system axis name	ascii	0	255	
1323		3rd axis Error detect-ON area	0.001mm	0	255	
1373		3rd axis Reduced vibration level when servo stop	%	0	100	
1553		3rd axis backlash compensation amount	0.1micron	0	32767	
1563		3rd axis No of teeth of monitor when servo feed change	tooth	0	255	
1573		3rd axis No of teeth of screw side when servo feed change	tooth	0	255	
1600		3rd axis Position loop gain Kp	0.01[1/S]	500	20000	
1601		3rd axis Velocity loop gain Kv	0.1[1/S]	350	32767	
1602		3rd axis Speed loop integration time constant Ti	0.01msec	26	32767	
1603		3rd axis Second position loop gain Kp	0.01[1/S]	500	20000	
1604		3rd axis Speed feed forward gain Kvfff	%	0	100	
1605		3rd axis Second velocity loop gain Kv	0.1[1/S]	350	32767	
1606		3rd axis First step axis torsion filter time	0.01msec	1	32767	
1607		3rd axis Second step axis torsion filter time constant Tn	0.01msec	1	32767	
1608		3rd axis Third step axis torsion filter time constant Tn	0.01msec	1	32767	
1609		3rd axis Monitor board signal selection multiplication		0	32767	
1643		3rd axis Variable in position check No1 area	0.001mm	0	32767	
1653		3rd axis Variable in position check No2 area	0.001mm	0	32767	For caned cycle and solid tap
1673		3rd axis torque limit value (+)	%	0	32767	
1683		3rd axis Servo Damping, observer time constant	Hz	0	32767	
1703		3rd axis Servo Damping, load inertia fine adjust	%	0	10000	
1713		3rd axis backlash time constant	0.01msec	0	32767	
1753		3rd axis Servo Damping, high pass filter time const	micro sec	0	32767	
1783		3rd axis contour compensation 2nd coefficient	0.001times	0	32767	

Address	Bit	Description	Register Units	Minimum Value	Maximum Value	Long Description
1793		3rd axis Servo Damping, low pass filter time const	micro sec	0	32767	
1803		3rd axis contour compensation coefficient	0.001times	0	32767	
1813		3rd axis Servo Damping, compensation gain	%	-2000	2000	
1823		3rd axis Motion amount or table rotation	0.001mm	0	999999999	
1833		3rd axis load inertia	%	0	32767	
1843		3rd axis separately PG, No. of pulses / motor rev	pulse	0	999999999	
1853		3rd axis Virtual C phase distance	0.001deg	0	999999999	
2002	2	3rd axis validity of automatic mode handle offset		0	1	
2463		3rd axis rapid feed accel/decel time constant	msec	0	32767	Set multiple of 4
2483		3rd axis backlash compensation amount in G01	0.1micron	-32767	32767	
2493		3rd axis backlash compensation amount in Handle	0.1micron	-32767	32767	
2503		3rd axis accel/decel time constant in feed cut	msec	0	32767	
2513		3rd axis accel/decel time constant in thread/tap	msec	0	32767	
2523		3rd axis reference point return approach speed	mm/min, deg/min	0	32767	
2533		3rd axis reference point return creep speed	mm/min, deg/min	0	32767	
2563		3rd axis accel/decel time constant in handle	msec	0	32767	Set multiple of 4
2573		3rd axis accel/decel time constant in No2 G00 mode	msec	0	32767	Set multiple of 4
2593		3rd axis rapid feed accel/decel S-curve		0	20	
2603		3rd axis rapid feed accel/decel S-curve in 2nd S		0	15	
2803		3rd axis Rapid feed rate	mm/min	0	240000	
2813		3rd axis rapid feed rate in 2nd S-curve accel/dece	mm/min, deg/min	0	240000	
2823		3rd axis bias in normal cutting accel/decel	mm/min, deg/min	0	240000	
2833		3rd axis bias in thread cutting accel/decel	mm/min, deg/min	0	240000	

Address	Bit	Description	Register Units	Minimum Value	Maximum Value	Long Description
2853		3rd axis second G00 feedrate	mm/min, deg/min	0	240000	
4002	2	3rd axis Reference point return direction		0	1	
4004	2	Alarm occur if axis move command before ZRN 3rd axis		0	1	Occurrence of alarm if movement command other than G28 is executed without carrying out manual or automatic reference point return for 3rd axis
4006	2	3rd axis Automatic coordinate system setting		0	1	
4014	2	3rd axis Direction of G60 unidirectional positioning		0	1	
4022	2	3rd axis validity of reference point return		0	1	
4024	2	3rd axis validity of playback write		0	1	
4453		3rd axis reference point return traverse	0.001mm	0	32767	
4463		3rd axis overtravel distance in G60	0.001mm	0	32767	
4553		Virtual C-phase shift distance 3rd axis	0.001mm	-32767	32767	
4803		3rd axis automatic coordinate setup value when mm	0.001mm	-999999999	999999999	
4813		3rd axis automatic coordinate setup value when inch	0.0001inch	-393700787	393700787	
5015	2	3rd axis PLC control axis switch over		0	1	
5103		3rd axis PLC axis control group		0	3	
5403		Time from ESP signal rising to base block on 3rd axis	msec	0	32767	multiply of 10msec
6000	2	Pitch error compensation 3rd axis		0	1	
6002	2	No.1 stored stroke limit check 3rd axis execution		0	1	
6004	2	Execution of stored stroke limit check for rotary 3rd axis		0	1	
6006	2	Axis disconnection 3rd axis		0	1	
6103		3rd axis, pitch error compensation		0	3	
6403		3rd axis, pitch error start memory number		0	1151	
6413		3rd axis, pitch error completion memory number		0	1151	

Address	Bit	Description	Register Units	Minimum Value	Maximum Value	Long Description
6423		3rd axis, pitch error reference point memory number		0	1151	
6803		3rd axis, pitch error compensation intervals	0.001mm	0	99999999	
6813		3rd axis, second reference point position	0.001mm	-99999999	99999999	
6823		3rd axis, third reference point position	0.001mm	-99999999	99999999	
6833		3rd axis, fourth reference point position	0.001mm	-99999999	99999999	
6863		3rd axis, pitch error compensation stroke (maximum)	0.001mm	-99999999	99999999	
6873		3rd axis, pitch error compensation stroke	0.001mm	-99999999	99999999	
6883		3rd axis, pitch error comp reference point position	0.001mm	-99999999	99999999	
6903		No.1 stored stroke limit 3rd axis (+)	0.001mm	-99999999	99999999	
6913		No.1 stored stroke limit 3rd axis (-)	0.001mm	-99999999	99999999	
8000	2	Absolute motor zero return condition 3rd axis		0	1	
8001	2	Absolute motor position gap condition 3rd axis		0	1	
8403		3rd axis, fine adjust amount in zero point		-32767	32767	
8413		3rd axis, position gap distance limit when power ON		0	32767	
8473		3rd axis (- to +) roundness irregularity Integral constant	msec	0	32767	
8483		3rd axis (- to +) roundness irregularity completion torque	0.01%	0	20000	
8493		3rd axis roundness irregularity Timing parameter	0.01[1/S]	-32767	32767	
8523		3rd axis roundness irregularity weight compensation torque	0.01%	-12000	12000	
8803		3rd axis, power OFF machine position	0.001mm	-99999999	99999999	
8813		3rd axis, offset amount in zero point setting	pulse	-99999999	99999999	
8823		3rd axis, shift amount in zero point setting	0.001mm	-99999999	99999999	

4th Axis

Address	Bit	Description	Register Units	Minimum Value	Maximum Value	Long Description
1023	0	4th axis YENET station number		0	15	4th Physical servo axis YENET1200 station number setting (No. 2 to No. 15 station)
	5	4th axis debug mode		0	1	
	6	4th axis Physical servo axis specifications		0	1	
	7	4th axis Physical servo axis enable		0	1	
1033	0	4th axis Velocity loop control method		0	1	
	1	4th axis Velocity loop control automatic setting		0	1	
	6	4th axis Axis type		0	1	
	7	4th axis Servo Motor rotation direction		0	1	
1047	0	4th axis Servo feed amount change		0	1	
	1	4th axis Absolute encoder		0	1	
	2	4th axis Disregarding error pulse at emergency stop		0	1	
	3	4th axis Follow-up processing for servo OFF		0	1	
	4	4th axis Use of absolute encoder		0	1	
	5	4th axis Zero return Virtual C phase motor 1 rev		0	1	
	6	4th axis Infinite length for rotary axis control		0	1	
	7	4th axis Use of 17-bit encoder		0	1	
1064	0	Setting of motor selection code for 4th axis		0	255	
1070	3	External torque observer 4th axis		0	1	Availability of digital amplifier offset external torque observer
1074	0	4th axis motor encoder type		0	255	
1080	3	4th axis roundness irregularity compensation		0	1	
1084	0	4th axis Externally installed encoder type		0	255	
1096	3	4th axis Servo Damping control		0	1	
1097	3	4th axis Reduced vibration when servo stop		0	1	

Address	Bit	Description	Register Units	Minimum Value	Maximum Value	Long Description
1109		4th Servo axis display name	ascii	0	255	
1151		4th Servo axis automatic system axis name	ascii	0	255	
1201		4th axis address name during high speed mode	ascii	0	255	
1324		4th axis Error detect-ON area	0.001mm	0	255	
1374		4th axis Reduced vibration level when servo stop	%	0	100	
1554		4th axis backlash compensation amount	0.1micron	0	32767	
1564		4th axis No of teeth of monitor when servo	tooth	0	255	
1574		4th axis No of teeth of screw side when servo feed change	tooth	0	255	
1610		4th axis Position loop gain Kp	0.01[1/S]	500	20000	
1611		4th axis Velocity loop gain Kv	0.1[1/S]	350	32767	
1612		4th axis Speed loop integration time constant Ti	0.01msec	26	32767	
1613		4th axis Second position loop gain Kp	0.01[1/S]	500	20000	
1614		4th axis Speed feed forward gain Kvfff	%	0	100	
1615		4th axis Second velocity loop gain Kv	0.1[1/S]	350	32767	
1616		4th axis First step axis torsion filter time constant Tn	0.01msec	1	32767	
1617		4th axis Second step axis torsion filter time	0.01msec	1	32767	
1618		4th axis Third step axis torsion filter time constant Tn	0.01msec	1	32767	
1619		4th axis Monitor board signal selection, multiplication		0	32767	
1644		4th axis Variable in position check No1 area	0.001mm	0	32767	
1654		4th axis Variable in position check No2 area	0.001mm	0	32767	For caned cycle and solid tap
1674		4th axis torque limit value (+)	%	0	32767	
1684		4th axis Servo Damping, observer time	Hz	0	32767	
1704		4th axis Servo Damping, load inertia fine adjust	%	0	10000	
1714		4th axis backlash time constant	0.01msec	0	32767	

Address	Bit	Description	Register Units	Minimum Value	Maximum Value	Long Description
1754		4th axis Servo Damping, high pass filter time const	micro sec	0	32767	
1784		4th axis contour compensation 2nd coefficient	0.001times	0	32767	
1794		4th axis Servo Damping, low pass filter time const	micro sec	0	32767	
1804		4th axis contour compensation coefficient	0.001times	0	32767	
1814		4th axis Servo Damping, compensation gain	%	-2000	2000	
1824		4th axis Motion amount or table rotation angle/motor rev	0.001mm	0	999999999	
1834		4th axis load inertia	%	0	32767	
1844		4th axis separately PG, No. of pulses / motor rev	pulse	0	999999999	
1854		4th axis Virtual C phase distance	0.001deg	0	999999999	
2002	3	4th axis validity of automatic mode handle		0	1	
2464		4th axis rapid feed accel/decel time constant	msec	0	32767	Set multiple of 4
2484		4th axis backlash compensation amount in G01 mode	0.1micron	-32767	32767	
2494		4th axis backlash compensation amount in Handle	0.1micron	-32767	32767	
2504		4th axis accel/decel time constant in feed cut	msec	0	32767	
2514		4th axis accel/decel time constant in thread/tap	msec	0	32767	
2524		4th axis reference point return approach speed	mm/min, deg/min	0	32767	
2534		4th axis reference point return creep speed	mm/min, deg/min	0	32767	
2564		4th axis accel/decel time constant in handle feed	msec	0	32767	Set multiple of 4
2574		4th axis accel/decel time constant in No2 G00	msec	0	32767	Set multiple of 4
2594		4th axis rapid feed accel/decel S-curve		0	20	
2604		4th axis rapid feed accel/decel S-curve in 2nd S		0	15	
2804		4th axis Rapid feed rate	mm/min	0	240000	
2814		4th axis rapid feed rate in 2nd S-curve accel/dece	mm/min, deg/min	0	240000	

Address	Bit	Description	Register Units	Minimum Value	Maximum Value	Long Description
2824		4th axis bias in normal cutting accel/decel	mm/min, deg/min	0	240000	
2834		4th axis bias in thread cutting accel/decel	mm/min, deg/min	0	240000	
2854		4th axis second G00 feedrate	mm/min, deg/min	0	240000	
4002	3	4th axis Reference point return direction		0	1	
4004	3	Alarm occur if axis move command before ZRN 4th axis		0	1	Occurrence of alarm if movement command other than G28 is executed without carrying out manual or automatic reference point return for 4th axis
4006	3	4th axis Automatic coordinate system setting		0	1	
4014	3	4th axis Direction of G60 unidirectional positioning		0	1	
4022	3	4th axis validity of reference point return		0	1	
4024	3	4th axis validity of playback write		0	1	
4454		4th axis reference point return traverse distance	0.001mm	0	32767	
4464		4th axis overtravel distance in G60	0.001mm	0	32767	
4554		Virtual C-phase shift distance 4th axis	0.001mm	-32767	32767	
4804		4th axis automatic coordinate setup value when mm	0.001mm	-99999999	99999999	
4814		4th axis automatic coordinate setup value	0.0001inch	-393700787	393700787	
5015	3	4th axis PLC control axis switch over		0	1	
5104		4th axis PLC axis control group		0	3	
5404		Time from ESP signal rising to base block on 4th axis	msec	0	32767	multiply of 10msec
6000	3	Pitch error compensation 4th axis		0	1	
6002	3	No.1 stored stroke limit check 4th axis execution		0	1	
6004	3	Execution of stored stroke limit check for rotary 4th axis		0	1	
6006	4	Axis disconnection 4th axis		0	1	
6104		4th axis, pitch error compensation multiplication		0	3	

Address	Bit	Description	Register Units	Minimum Value	Maximum Value	Long Description
6404		4th axis, pitch error start memory number		0	1151	
6414		4th axis, pitch error completion memory number		0	1151	
6424		4th axis, pitch error reference point memory number		0	1151	
6804		4th axis, pitch error compensation intervals	0.001mm	0	99999999	
6814		4th axis, second reference point position	0.001mm	-99999999	99999999	
6824		4th axis, third reference point position	0.001mm	-99999999	99999999	
6834		4th axis, fourth reference point position	0.001mm	-99999999	99999999	
6864		4th axis, pitch error compensation stroke (maximum)	0.001mm	-99999999	99999999	
6874		4th axis, pitch error compensation stroke (minimum)	0.001mm	-99999999	99999999	
6884		4th axis, pitch error comp reference point position	0.001mm	-99999999	99999999	
6904		No.1 stored stroke limit 4th axis (+)	0.001mm	-99999999	99999999	
6914		No.1 stored stroke limit 4th axis (-)	0.001mm	-99999999	99999999	
8000	3	Absolute motor zero return condition 4th axis		0	1	
8001	3	Absolute motor position gap condition 4th axis		0	1	
8404		4th axis, fine adjust amount in zero point setting		-32767	32767	
8414		4th axis, position gap distance limit when power on		0	32767	
8474		4th axis (- to +) roundness irregularity Integral constant	msec	0	32767	
8484		4th axis (- to +) roundness irregularity completion torque	0.01%	0	20000	
8494		4th axis roundness irregularity Timing	0.01[1/S]	-32767	32767	
8524		4th axis roundness irregularity weight compensation torque	0.01%	-12000	12000	
8804		4th axis, power off machine position	0.001mm	-99999999	99999999	
8814		4th axis, offset amount in zero point setting	pulse	-99999999	99999999	
8824		4th axis, shift amount in zero point setting	0.001mm	-99999999	99999999	

5th Axis

Address	Bit	Description	Register Units	Minimum Value	Maximum Value	Long Description
1024	0	5th axis YENET station number		0	15	5th Physical servo axis YENET1200 station number setting (No. 2 to No. 15 station)
	5	5th axis debug mode		0	1	
	6	5th axis Physical servo axis specifications		0	1	
	7	5th axis Physical servo axis enable		0	1	
1034	0	5th axis Velocity loop control method		0	1	
	1	5th axis Velocity loop control automatic setting		0	1	
	6	5th axis Axis type		0	1	
	7	5th axis Servo Motor rotation direction		0	1	
1048	0	5th axis Servo feed amount change		0	1	
	1	5th axis Absolute encoder		0	1	
	2	5th axis Disregarding error pulse at emergency		0	1	
	3	5th axis Follow-up processing for servo OFF		0	1	
	4	5th axis Use of absolute encoder		0	1	
	5	5th axis Zero return Virtual C phase motor 1 rev		0	1	
	6	5th axis Infinite length for rotary axis control		0	1	
	7	5th axis Use of 17-bit encoder		0	1	
1065	0	Setting of motor selection code for 5th axis		0	255	
1070	4	External torque observer 5th axis		0	1	Availability of digital amplifier offset external torque observer
1075	0	5th axis motor encoder type		0	255	
1080	4	5th axis roundness irregularity compensation		0	1	
1085	0	5th axis Externally installed encoder type		0	255	
1096	4	5th axis Servo Damping control		0	1	
1097	4	5th axis Reduced vibration when servo stop		0	1	
1112		5th Servo axis display name	ascii	0	255	

Address	Bit	Description	Register Units	Minimum Value	Maximum Value	Long Description
1154		5th Servo axis automatic system axis name	ascii	0	255	
1202		5th axis address name during high speed mode	ascii	0	255	
1325		5th axis Error detect-ON area	0.001mm	0	255	
1375		5th axis Reduced vibration level when servo stop	%	0	100	
1555		5th axis backlash compensation amount	0.1micron	0	32767	
1565		5th axis No of teeth of monitor when servo feed change	tooth	0	255	
1575		5th axis No of teeth of screw side when servo	tooth	0	255	
1620		5th axis Position loop gain Kp	0.01[1/S]	500	20000	
1621		5th axis Velocity loop gain Kv	0.1[1/S]	350	32767	
1622		5th axis Speed loop integration time constant Ti	0.01msec	26	32767	
1623		5th axis Second position loop gain Kp	0.01[1/S]	500	20000	
1624		5th axis Speed feed forward gain Kvfff	%	0	100	
1625		5th axis Second velocity loop gain Kv	0.1[1/S]	350	32767	
1626		5th axis First step axis torsion filter time constant Tn	0.01msec	1	32767	
1627		5th axis Second step axis torsion filter time constant Tn	0.01msec	1	32767	
1628		5th axis Third step axis torsion filter time constant Tn	0.01msec	1	32767	
1629		5th axis Monitor board signal selection, multiplication		0	32767	
1645		5th axis Variable in position check No1 area	0.001mm	0	32767	
1655		5th axis Variable in position check No2 area	0.001mm	0	32767	For caned cycle and solid tap
1675		5th axis torque limit value (+)	%	0	32767	
1685		5th axis Servo Damping, observer time constant	Hz	0	32767	
1705		5th axis Servo Damping, load inertia fine adjust	%	0	10000	
1715		5th axis backlash time constant	0.01msec	0	32767	
1755		5th axis Servo Damping, high pass filter time const	micro sec	0	32767	

Address	Bit	Description	Register Units	Minimum Value	Maximum Value	Long Description
1785		5th axis contour compensation 2nd coefficient	0.001times	0	32767	
1795		5th axis Servo Damping, low pass filter time const	micro sec	0	32767	
1805		5th axis contour compensation coefficient	0.001times	0	32767	
1815		5th axis Servo Damping, compensation gain	%	-2000	2000	
1825		5th axis Motion amount or table rotation angle/motor rev	0.001mm	0	999999999	
1835		5th axis load inertia	%	0	32767	
1845		5th axis separately PG, No. of pulses / motor rev	pulse	0	999999999	
1855		5th axis Virtual C phase distance	0.001deg	0	999999999	
2002	4	5th axis validity of automatic mode handle offset		0	1	
2465		5th axis rapid feed accel/decel time constant	msec	4	32767	Set multiple of 4
2485		5th axis backlash compensation amount in G01 mode	0.1micron	-32767	32767	
2495		5th axis backlash compensation amount in Handle	0.1micron	-32767	32767	
2505		5th axis accel/decel time constant in feed cut	msec	0	32767	
2515		5th axis accel/decel time constant in thread/tap	msec	0	32767	
2525		5th axis reference point return approach speed	mm/min, deg/min	0	32767	
2535		5th axis reference point return creep speed	mm/min, deg/min	0	32767	
2565		5th axis accel/decel time constant in handle feed	msec	0	32767	Set multiple of 4
2575		5th axis accel/decel time constant in No2 G00 mode	msec	0	32767	Set multiple of 4
2595		5th axis rapid feed accel/decel S-curve		0	20	
2605		5th axis rapid feed accel/decel S-curve in 2nd S		0	15	
2805		5th axis Rapid feed rate	mm/min	0	240000	
2815		5th axis rapid feed rate in 2nd S-curve	mm/min, deg/min	0	240000	
2825		5th axis bias in normal cutting accel/decel	mm/min, deg/min	0	240000	

Address	Bit	Description	Register Units	Minimum Value	Maximum Value	Long Description
2835		5th axis bias in thread cutting accel/ decel	mm/min, deg/min	0	240000	
2855		5th axis second G00 feedrate	mm/min, deg/min	0	240000	
4002	4	5th axis Reference point return direction		0	1	
4004	4	Alarm occur if axis move command before ZRN 5th axis		0	1	Occurrence of alarm if movement command other than G28 is executed without carrying out manual or automatic reference point return for 5th axis
4006	4	5th axis Automatic coordinate system setting		0	1	
4014	4	5th axis Direction of G60 unidirectional positioning		0	1	
4022	4	5th axis validity of reference point return		0	1	
4024	4	5th axis validity of playback write		0	1	
4455		5th axis reference point return traverse distance	0.001mm	0	32767	
4465		5th axis overtravel distance in G60	0.001mm	0	32767	
4555		Virtual C-phase shift distance 5th axis	0.001mm	-32767	32767	
4805		5th axis automatic coordinate setup value when mm	0.001mm	-999999999	999999999	
4815		5th axis automatic coordinate setup value when inch	0.0001inch	-393700787	393700787	
5015	4	5th axis PLC control axis switch over		0	1	
5105		5th axis PLC axis control group		0	3	
5405		Time from ESP signal rising to base block on 5th axis	msec	0	32767	multiply of 10msec
6000	4	Pitch error compensation 5th axis		0	1	
6002	4	No.1 stored stroke limit check 5th axis execution		0	1	
6004	4	Execution of stored stroke limit check for rotary 5th axis		0	1	
6006	4	Axis disconnection 5th axis		0	1	
6105		5th axis, pitch error compensation multiplication		0	3	
6405		5th axis, pitch error start memory number		0	1151	

Address	Bit	Description	Register Units	Minimum Value	Maximum Value	Long Description
6415		5th axis, pitch error completion memory number		0	1151	
6425		5th axis, pitch error reference point memory number		0	1151	
6805		5th axis, pitch error compensation intervals	0.001mm	0	99999999	
6815		5th axis, second reference point position	0.001mm	-99999999	99999999	
6825		5th axis, third reference point position	0.001mm	-99999999	99999999	
6835		5th axis, fourth reference point position	0.001mm	-99999999	99999999	
6865		5th axis, pitch error compensation stroke (maximum)	0.001mm	-99999999	99999999	
6875		5th axis, pitch error compensation stroke (minimum)	0.001mm	-99999999	99999999	
6885		5th axis, pitch error comp reference point position	0.001mm	-99999999	99999999	
6905		No.1 stored stroke limit 5th axis (+)	0.001mm	-99999999	99999999	
6915		No.1 stored stroke limit 5th axis (-)	0.001mm	-99999999	99999999	
8000	4	Absolute motor zero return condition 5th axis		0	1	
8001	4	Absolute motor position gap condition 5th axis		0	1	
8405		5th axis, fine adjust amount in zero point setting		-32767	32767	
8415		5th axis, position gap distance limit when power ON		0	32767	
8475		5th axis (- to +) roundness irregularity Integral constant	msec	0	32767	
8485		5th axis (- to +) roundness irregularity completion torque	0.01%	0	20000	
8495		5th axis roundness irregularity Timing parameter	0.01[1/S]	-32767	32767	
8525		5th axis roundness irregularity weight	0.01%	-12000	12000	
8805		5th axis, power off machine position	0.001mm	-99999999	99999999	
8815		5th axis, offset amount in zero point setting	pulse	-99999999	99999999	
8825		5th axis, shift amount in zero point setting	0.001mm	-99999999	99999999	

Absolute Encoder

Address	Bit	Description	Register Units	Minimum Value	Maximum Value	Long Description
pm1044	1	1st axis Absolute encoder 0: Motor PG 1: Separately installed		0	1	
	4	1st axis Use of absolute encoder 0: Not used 1: Used		0	1	
pm1045	1	2nd axis Absolute encoder 1: Separately installed PG 0: Motor PG		0	1	
	4	2nd axis Use of absolute encoder 1: Used 0: Not used		0	1	
pm1046	1	3rd axis Absolute encoder 1: Separately installed PG 0: Motor PG		0	1	
	4	3rd axis Use of absolute encoder 0: Not used 1: Used		0	1	
pm1047	1	4th axis Absolute encoder 0: Motor PG 1: Separately installed		0	1	
	4	4th axis Use of absolute encoder 1: Used 0: Not used		0	1	
pm1048	1	5th axis Absolute encoder 1: Separately installed PG 0: Motor PG		0	1	
	4	5th axis Use of absolute encoder 1: Used 0: Not used		0	1	

Address	Bit	Description	Register Units	Minimum Value	Maximum Value	Long Description
pm8000	0	Absolute motor zero return condition 1st axis 0: Not executed 1: Executed		0	1	
	1	Absolute motor zero return condition 2nd axis 0: Not executed 1: Executed		0	1	
	2	Absolute motor zero return condition 3rd axis 0: Not executed 1: Executed		0	1	
	3	Absolute motor zero return condition 4th axis 1: Executed 0: Not executed		0	1	
	4	Absolute motor zero return condition 5th axis 0: Not executed 1: Executed		0	1	
pm8002	0	Absolute motor zero return type 0: Manual low speed type zero return 1: Floating machine origin set-up type 2: Machine reference position fixed origin		0	3	
pm8401		1st axis, fine adjust amount in zero point setting		-32767	32767	
pm8402		2nd axis, fine adjust amount in zero point setting		-32767	32767	
pm8403		3rd axis, fine adjust amount in zero point setting		-32767	32767	
pm8404		4th axis, fine adjust amount in zero point setting		-32767	32767	
pm8405		5th axis, fine adjust amount in zero point setting		-32767	32767	
pm8411		1st axis, position gap distance limit when power on		0	32767	
pm8412		2nd axis, position gap distance limit when power on		0	32767	
pm8413		3rd axis, position gap distance limit when power on		0	32767	
pm8414		4th axis, position gap distance limit when power on		0	32767	
pm8415		5th axis, position gap distance limit when power on		0	32767	
pm8801		1st axis, power off machine position	0.001mm	-999999999	999999999	

Address	Bit	Description	Register Units	Minimum Value	Maximum Value	Long Description
pm8802		2nd axis, power off machine position	0.001mm	-999999999	999999999	
pm8803		3rd axis, power off machine position	0.001mm	-999999999	999999999	
pm8804		4th axis, power off machine position	0.001mm	-999999999	999999999	
pm8805		5th axis, power off machine position	0.001mm	-999999999	999999999	
pm8811		1st axis, offset amount in zero point setting	pulse	-999999999	999999999	
pm8812		2nd axis, offset amount in zero point setting	pulse	-999999999	999999999	
pm8813		3rd axis, offset amount in zero point setting	pulse	-999999999	999999999	
pm8814		4th axis, offset amount in zero point setting	pulse	-999999999	999999999	
pm8815		5th axis, offset amount in zero point setting	pulse	-999999999	999999999	
pm8821		1st axis, shift amount in zero point setting	0.001mm	-999999999	999999999	
pm8822		2nd axis, shift amount in zero point setting	0.001mm	-999999999	999999999	
pm8823		3rd axis, shift amount in zero point setting	0.001mm	-999999999	999999999	
pm8824		4th axis, shift amount in zero point setting	0.001mm	-999999999	999999999	
pm8825		5th axis, shift amount in zero point setting	0.001mm	-999999999	999999999	

Advanced Axis

Address	Bit	Description	Register Units	Minimum Value	Maximum Value	Long Description
1030	0	1st axis Velocity loop control method		0	1	
	1	1st axis Velocity loop control automatic setting		0	1	
1031	0	2nd axis Velocity loop control method		0	1	
	1	2nd axis Velocity loop control automatic setting		0	1	
1032	0	3rd axis Velocity loop control method		0	1	
	1	3rd axis Velocity loop control automatic setting		0	1	
1033	0	4th axis Velocity loop control method		0	1	
	1	4th axis Velocity loop control automatic		0	1	
1034	0	5th axis Velocity loop control method		0	1	
	1	5th axis Velocity loop control automatic setting		0	1	
1044	0	1st axis Servo feed amount change		0	1	
	2	1st axis Disregarding error pulse at emergency stop		0	1	
	3	1st axis Follow-up processing for servo OFF		0	1	
	6	1st axis Infinite length for rotary axis		0	1	
1045	0	2nd axis Servo feed amount change		0	1	
	2	2nd axis Disregarding error pulse at emergency stop		0	1	
	3	2nd axis Follow-up processing for servo OFF		0	1	
	6	2nd axis Infinite length for rotary axis control		0	1	
1046	0	3rd axis Servo feed amount change		0	1	
	2	3rd axis Disregarding error pulse at emergency		0	1	
	3	3rd axis Follow-up processing for servo OFF		0	1	
	6	3rd axis Infinite length for rotary axis control		0	1	

Address	Bit	Description	Register Units	Minimum Value	Maximum Value	Long Description
1047	0	4th axis Servo feed amount change		0	1	
	2	4th axis Disregarding error pulse at emergency stop		0	1	
	3	4th axis Follow-up processing for servo OFF		0	1	
	6	4th axis Infinite length for rotary axis		0	1	
1048	0	5th axis Servo feed amount change		0	1	
	2	5th axis Disregarding error pulse at emergency stop		0	1	
	3	5th axis Follow-up processing for servo OFF		0	1	
	6	5th axis Infinite length for rotary axis control		0	1	
1070	0	External torque observer 1st axis		0	1	Availability of digital amplifier offset external torque observer
	1	External torque observer 2nd axis		0	1	Availability of digital amplifier offset external torque observer
	2	External torque observer 3rd axis		0	1	Availability of digital amplifier offset external torque observer
	3	External torque observer 4th axis		0	1	Availability of digital amplifier offset external torque observer
	4	External torque observer 5th axis		0	1	Availability of digital amplifier offset external torque observer
1332		Error detect-ON area during spindle loop control B	0.001mm	0	255	
1352		Servo error range when spindle loop control Gear B	%	0	255	Spindle, Multiplication relative to rapid feed in servo error range for gear B
1435		Spindle, max speed corresponding to 10V (Gear B)	r/min	0	32767	
1436		Maximum spindle speed during solid tap (Gear B)	r/min	0	32767	
1437		Spindle position loop gain for solid tap (Gear B)	0.01[1/S]	0	32767	
1439		Spindle gear B base speed	r/min	0	32767	
1506		Rotary tool spindle sync offset parameter K1		-32767	32676	

Address	Bit	Description	Register Units	Minimum Value	Maximum Value	Long Description
1507		Rotary tool spindle sync offset parameter K2		-32767	32676	
1514		No. of teeth of gear B on the spindle side intermediate	tooth	0	32767	No. of teeth of gear B on the spindle side for spindle loop control If there is no intermediate gear, set motor side one
1515		No. of teeth of gear B on the spindle intermediate	tooth	0	32767	No. of teeth of the spindle intermediate gear B used for spindle loop control If there is no intermediate gear, set 0
1516		No. of teeth of gear B on the motor intermediate	tooth	0	32767	No. of teeth of the motor intermediate gear B used for spindle loop control If there is no intermediate gear, set 0
1517		No. of teeth of gear B on the motor side	tooth	0	32767	No. of teeth on the motor side of gear B used for spindle loop control
1561		1st axis No of teeth of monitor when servo feed change	tooth	1	255	If there is no intermediate gear, set 0
1562		2nd axis No of teeth of monitor when servo feed change	tooth	0	255	
1563		3rd axis No of teeth of monitor when servo feed change	tooth	0	255	
1564		4th axis No of teeth of monitor when servo feed change	tooth	0	255	
1565		5th axis No of teeth of monitor when servo feed change	tooth	0	255	
1571		1st axis No of teeth of screw side when servo	tooth	0	255	
1572		2nd axis No of teeth of screw side when servo feed change	tooth	0	255	
1573		3rd axis No of teeth of screw side when servo feed change	tooth	0	255	
1574		4th axis No of teeth of screw side when servo feed change	tooth	0	255	
1575		5th axis No of teeth of screw side when servo feed change	tooth	0	255	
1583		1st axis Second position loop gain Kp	0.01[1/S]	500	20000	
1584		1st axis Speed feed forward gain Kvfff	%	0	100	
1585		1st axis Second velocity loop gain Kv	0.1[1/S]	350	32767	

Address	Bit	Description	Register Units	Minimum Value	Maximum Value	Long Description
1587		1st axis Second step axis torsion filter time constant Tn	0.01msec	1	32767	
1588		1st axis Third step axis torsion filter time	0.01msec	1	32767	
1589		1st axis Monitor board signal selection, multiplication		0	32767	
1593		2nd axis Second position loop gain Kp	0.01[1/S]	500	20000	
1594		2nd axis Speed feed forward gain Kvfff	%	0	100	
1595		2nd axis Second velocity loop gain Kv	0.1[1/S]	350	32767	
1597		2nd axis Second step axis torsion filter time constant Tn	0.01msec	1	32767	
1598		2nd axis Third step axis torsion filter time	0.01msec	1	32767	
1599		2nd axis Monitor board signal selection, multiplication		0	32767	
1603		3rd axis Second position loop gain Kp	0.01[1/S]	500	20000	
1604		3rd axis Speed feed forward gain Kvfff	%	0	100	
1605		3rd axis Second velocity loop gain Kv	0.1[1/S]	350	32767	
1607		3rd axis Second step axis torsion filter time constant Tn	0.01msec	1	32767	
1608		3rd axis Third step axis torsion filter time	0.01msec	1	32767	
1609		3rd axis Monitor board signal selection, multiplication		0	32767	
1613		4th axis Second position loop gain Kp	0.01[1/S]	500	20000	
1614		4th axis Speed feed forward gain Kvfff	%	0	100	
1615		4th axis Second velocity loop gain Kv	0.1[1/S]	350	32767	
1617		4th axis Second step axis torsion filter time constant Tn	0.01msec	1	32767	
1618		4th axis Third step axis torsion filter time	0.01msec	1	32767	
1619		4th axis Monitor board signal selection, multiplication		0	32767	
1623		5th axis Second position loop gain Kp	0.01[1/S]	500	20000	

Address	Bit	Description	Register Units	Minimum Value	Maximum Value	Long Description
1624		5th axis Speed feed forward gain Kvfff	%	0	100	
1625		5th axis Second velocity loop gain Kv	0.1[1/S]	350	32767	
1627		5th axis Second step axis torsion filter time constant Tn	0.01msec	1	32767	
1628		5th axis Third step axis torsion filter time constant Tn	0.01msec	1	32767	
1629		5th axis Monitor board signal selection, multiplication		0	32767	
2831		1st axis bias in thread cutting accel/ decel	mm/min, deg/min	0	240000	
2832		2nd axis bias in thread cutting accel/ decel	mm/min, deg/min	0	240000	
2833		3rd axis bias in thread cutting accel/ decel	mm/min, deg/min	0	240000	
2834		4th axis bias in thread cutting accel/ decel	mm/min, deg/min	0	240000	
2835		5th axis bias in thread cutting accel/ decel	mm/min, deg/min	0	240000	

Auxiliary Axis

Address	Bit	Description	Register Units	Minimum Value	Maximum Value	Long Description
801		Sequence number setting 1 of brake point		0	99999	
802		Sequence number setting 2 of brake point		0	99999	
2004	0	Feedrate at the detection of 0.001mm or 0.0001inch		0	1	
3001	4	Priority between T / M06 if specify in same block		0	1	
4001	0	Mirror image mode when power ON or Reset		0	1	
4001	1	Tool radius offset mode when power ON or Reset		0	1	
4001	2	Mirror image for intermediate position of G28		0	1	Assumption of mirror image ON for the intermediate positioning point of G28 if M95 is set when power ON or NC Reset
4010	0	Processing after the change of offset amount		0	1	
4010	1	D code in the G12/G13 mode		0	1	
4010	6	Processing of D code after reset		0	1	
4010	7	H code after reset or reference point return		0	1	
4011	1	Designation of offset number for G45 - G48		0	1	
4012	0	Processing after the change of work shift amount		0	1	
4012	7	Work shift coordinate setting expansion address		0	1	
4020	4	Validity of B code macro execution on single block switch		0	1	
4020	5	Designation of argument in M code macro		0	1	
4020	6	Designation of multiple M codes in one block in M code macro		0	1	
4030	1	Next block buffering stop at T code command		0	1	
4030	7	Alarm occurrence at decimal with 2nd aux code		0	1	
4112		2nd auxiliary command address setting		0	6	
4400		Advance reading stop M code (1)		0	999	
4401		Advance reading stop M code (2)		0	999	

Address	Bit	Description	Register Units	Minimum Value	Maximum Value	Long Description
4402		Advance reading stop M code (3)		0	999	
4403		Advance reading stop M code (4)		0	999	
4404		Advance reading stop M code (5)		0	999	
4405		Advance reading stop M code (6)		0	999	
4406		Advance reading stop M code (7)		0	999	
4407		Advance reading stop M code (8)		0	999	
4408		Advance reading stop M code (9)		0	999	
4409		Advance reading stop M code (10)		0	999	

Auxiliary Function

Address	Bit	Description	Register Units	Minimum Value	Maximum Value	Long Description
4011	2	Manual ABS if no axis command in the block 1		0	1	Validity of manual absolute function if there is no axis move command in the block where incremental amount is generated
	3	Manual ABS if no axis command in the block 2		0	1	Validity of manual absolute function if there is no axis move command in the block where incremental amount is generated.
	7	Manual ABS for the incremental command		0	1	
4015	7	Approach speed for program restart		0	1	

Backlash

Address	Bit	Description	Register Units	Minimum Value	Maximum Value	Long Description
pm1551		1st axis backlash compensation amount	0.1micron	0	32767	
pm1552		2nd axis backlash compensation amount	0.1micron	0	32767	
pm1553		3rd axis backlash compensation amount	0.1micron	0	32767	
pm1554		4th axis backlash compensation amount	0.1micron	0	32767	
pm1555		5th axis backlash compensation amount	0.1micron	0	32767	
pm1711		1st axis backlash time constant	0.01msec	0	32767	
pm1712		2nd axis backlash time constant	0.01msec	0	32767	
pm1713		3rd axis backlash time constant	0.01msec	0	32767	
pm1714		4th axis backlash time constant	0.01msec	0	32767	
pm1715		5th axis backlash time constant	0.01msec	0	32767	
pm2481		1st axis backlash compensation amount in G01 mode	0.1micron	-32767	32767	
pm2482		2nd axis backlash compensation amount in G01 mode	0.1micron	-32767	32767	
pm2483		3rd axis backlash compensation amount in G01 mode	0.1micron	-32767	32767	
pm2484		4th axis backlash compensation amount in G01 mode	0.1micron	-32767	32767	
pm2485		5th axis backlash compensation amount in G01 mode	0.1micron	-32767	32767	
pm2491		1st axis backlash compensation amount in Handle	0.1micron	-32767	32767	
pm2492		2nd axis backlash compensation amount in Handle	0.1micron	-32767	32767	
pm2493		3rd axis backlash compensation amount in Handle	0.1micron	-32767	32767	
pm2494		4th axis backlash compensation amount in Handle	0.1micron	-32767	32767	
pm2495		5th axis backlash compensation amount in Handle	0.1micron	-32767	32767	

Basic

Address	Bit	Description	Register Units	Minimum Value	Maximum Value	Long Description
1240		Spindle number for executing solid tap		0	1	
1241		Servo axis number for executing solid tap		1	5	
1252		Return feedrate multiplication for solid tap	0.1times	1	255	
1260		Spindle loop control gear number (A)		0	4	
1261		Spindle loop control gear number (B)		0	4	
1321		1st axis Error detect-ON area	0.001mm	0	255	
1322		2nd axis Error detect-ON area	0.001mm	0	255	
1323		3rd axis Error detect-ON area	0.001mm	0	255	
1324		4th axis Error detect-ON area	0.001mm	0	255	
1325		5th axis Error detect-ON area	0.001mm	0	255	
1331		Error detect-ON area during spindle loop	0.001mm	0	255	
1351		Servo error range when spindle loop control	%	0	255	Spindle, Multiplication relative to rapid feed in servo error range
1416		Maximum spindle speed during solid tap	r/min	0	32767	
1417		Spindle position loop gain for solid tap	0.01[1/S]	0	32767	
1418		Spindle C-axis, max speed corresponding to 10V	r/min	0	666	Maximum spindle speed corresponding to 10 V of command (C-axis is used)
1419		Spindle gear A base speed	r/min	0	32767	
1500		Solid tap servo shaft retraction in-position	0.001mm	0	32767	
1502		Solid tap synchronization offset parameter K1		-32767	32767	
1503		Solid tap synchronization offset parameter K2		-32767	32767	
1510		No. of teeth of gear A on the spindle side	tooth	0	32767	No. of teeth of gear A on the spindle side for spindle loop control
1511		No. of teeth of gear A on the spindle intermediate	tooth	0	32767	No. of teeth of the spindle intermediate gear A used for spindle loop control If there is no intermediate gear, set motor side one

Address	Bit	Description	Register Units	Minimum Value	Maximum Value	Long Description
1512		No. of teeth of gear A on the motor intermediate	tooth	0	32767	No. of teeth of the motor intermediate gear A used for spindle loop control If there is no intermediate gear, set 0
1513		No. of teeth of gear A on the motor side	tooth	0	32767	No. of teeth on the motor side of gear A used for spindle loop control
1580		1st axis Position loop gain Kp	0.01[1/S]	500	20000	If there is no intermediate gear, set 0
1581		1st axis Velocity loop gain Kv	0.1[1/S]	350	32767	
1582		1st axis Speed loop integration time constant Ti	0.01msec	26	32767	
1586		1st axis First step axis torsion filter time constant Tn	0.01msec	1	32767	
1590		2nd axis Position loop gain Kp	0.01[1/S]	500	20000	
1591		2nd axis Velocity loop gain Kv	0.1[1/S]	350	32767	
1592		2nd axis Speed loop integration time constant Ti	0.01msec	26	32767	
1596		2nd axis First step axis torsion filter time constant Tn	0.01msec	1	32767	
1600		3rd axis Position loop gain Kp	0.01[1/S]	500	20000	
1601		3rd axis Velocity loop gain Kv	0.1[1/S]	350	32767	
1602		3rd axis Speed loop integration time constant Ti	0.01msec	26	32767	
1606		3rd axis First step axis torsion filter time constant Tn	0.01msec	1	32767	
1610		4th axis Position loop gain Kp	0.01[1/S]	500	20000	
1611		4th axis Velocity loop gain Kv	0.1[1/S]	350	32767	
1612		4th axis Speed loop integration time constant	0.01msec	26	32767	
1616		4th axis First step axis torsion filter time constant Tn	0.01msec	1	32767	
1620		5th axis Position loop gain Kp	0.01[1/S]	500	20000	
1621		5th axis Velocity loop gain Kv	0.1[1/S]	350	32767	
1622		5th axis Speed loop integration time constant Ti	0.01msec	26	32767	
1626		5th axis First step axis torsion filter time constant Tn	0.01msec	1	32767	
1821		1st axis Motion amount or table rotation	0.001mm	0	99999999	

Address	Bit	Description	Register Units	Minimum Value	Maximum Value	Long Description
1822		2nd axis Motion amount or table rotation angle/motor rev	0.001mm	0	999999999	
1823		3rd axis Motion amount or table rotation angle/motor rev	0.001mm	0	999999999	
1824		4th axis Motion amount or table rotation angle/motor rev	0.001mm	0	999999999	
1825		5th axis Motion amount or table rotation angle/motor rev	0.001mm	0	999999999	
1831		1st axis load inertia	%	0	32767	
1832		2nd axis load inertia	%	0	32767	
1833		3rd axis load inertia	%	0	32767	
1834		4th axis load inertia	%	0	32767	
1835		5th axis load inertia	%	0	32767	
2000	1	Dry run during thread cutting		0	1	
4015	5	G00 error detection during solid tap		0	1	
4015	6	Display peak value of synchronization error		0	1	

Canned Cycle

Address	Bit	Description	Register Units	Minimum Value	Maximum Value	Long Description
pm400		Dwell period for G76, G77	msec	0	32767	
pm401		Pitch dwell period for G73, G83	msec	0	32767	
pm805		Angle when G76, G77 are specified	0.001deg	0	360000	
pm870		Return amount of G73	0.001mm	0	99999999	Return stroke in G73 cycle (rapid traverse)
pm871		Return amount of G83	0.001mm	0	99999999	Return stroke in G83 cycle (rapid traverse)
pm873		Return amount of G184/G174	0.001mm	0	99999999	Return stroke in G184/G174 cycle (rapid traverse)
pm2864		Shift speed of canned cycle G76 and G77	mm/min	0	240000	
pm4016	1	Positioning mode in a canned cycle 0: G00 1: G00 or G01 which ever is present		0	1	
	2	M code to be output in the G74/G84 canned cycle 0: M code reverse one specified before start 1: M03 for G74 and M04 for G84		0	1	
	3	Output M05 at hole bottom in G74/G84 cycle 0: No 1: Yes		0	1	
	4	Execution type of G184/G174 1: Pecking cycle (type B) 0: Return to R-point		0	1	
	6	Solid tap in Dry run mode 0: Normal tap 1: Solid tap		0	1	
pm4017	1	Output of M05 before the output of M19 in the 0: No 1: Yes		0	1	
	2	Spindle over-ride during the execution of G84/G74 tap cycle 0: Fixed at 100% 1: Fixed at the value read at the start		0	1	
	3	Validity of pm0400 dwell time in the G76/G77 cycle 1: Valid 0: Invalid		0	1	
	4	Validity of pm0401 pitch dwell time 1: Valid 0: Invalid		0	1	

Configuration

Address	Bit	Description	Register Units	Minimum Value	Maximum Value	Long Description
1020	0	1st axis YENET station number		0	15	1st Physical servo axis YENET1200 station number setting (No. 2 to No. 15 station)
	5	1st axis debug mode		0	1	
	6	1st axis Physical servo axis specifications		0	1	
	7	1st axis Physical servo axis enable		0	1	
1021	0	2nd axis YENET station number		0	15	2nd Physical servo axis YENET1200 station number setting (No. 2 to No. 15 station)
	5	2nd axis debug mode		0	1	
	6	2nd axis Physical servo axis specifications		0	1	
	7	2nd axis Physical servo axis enable		0	1	
1022	0	3rd axis YENET station number		0	15	3rd Physical servo axis YENET1200 station number setting (No. 2 to No. 15 station)
	5	3rd axis debug mode		0	1	
	6	3rd axis Physical servo axis specifications		0	1	
	7	3rd axis Physical servo axis enable		0	1	
1023	0	4th axis YENET station number		0	15	4th Physical servo axis YENET1200 station number setting (No. 2 to No. 15 station)
	5	4th axis debug mode		0	1	
	6	4th axis Physical servo axis specifications		0	1	
	7	4th axis Physical servo axis enable		0	1	

Address	Bit	Description	Register Units	Minimum Value	Maximum Value	Long Description
1024	0	5th axis YENET station number		0	15	5th Physical servo axis YENET1200 station number setting (No. 2 to No. 15 station)
	5	5th axis debug mode		0	1	
	6	5th axis Physical servo axis specifications		0	1	
	7	5th axis Physical servo axis enable		0	1	
1030	6	1st axis Axis type		0	1	
	7	1st axis Servo Motor rotation direction		0	1	
1031	6	2nd axis Axis type		0	1	
1031	7	2nd axis Servo Motor rotation direction		0	1	
1032	6	3rd axis Axis type		0	1	
1032	7	3rd axis Servo Motor rotation direction		0	1	
1033	6	4th axis Axis type		0	1	
1033	7	4th axis Servo Motor rotation direction		0	1	
1034	6	5th axis Axis type		0	1	
1034	7	5th axis Servo Motor rotation direction		0	1	
1044	7	1st axis Use of 17-bit encoder		0	1	
1045	7	2nd axis Use of 17-bit encoder		0	1	
1046	7	3rd axis Use of 17-bit encoder		0	1	
1047	7	4th axis Use of 17-bit encoder		0	1	
1048	7	5th axis Use of 17-bit encoder		0	1	
1061	0	Setting of motor selection code for 1st axis		0	255	
1062	0	Setting of motor selection code for 2nd axis		0	255	
1063	0	Setting of motor selection code for 3rd axis		0	255	
1064	0	Setting of motor selection code for 4th axis		0	255	
1065	0	Setting of motor selection code for 5th axis		0	255	
1071	0	1st axis motor encoder type		0	255	

Address	Bit	Description	Register Units	Minimum Value	Maximum Value	Long Description
1072	0	2nd axis motor encoder type		0	255	
1073	0	3rd axis motor encoder type		0	255	
1074	0	4th axis motor encoder type		0	255	
1075	0	5th axis motor encoder type		0	255	
1100		1st Servo axis display name	ascii	0	255	
1103		2nd Servo axis display name	ascii	0	255	
1106		3rd Servo axis display name	ascii	0	255	
1109		4th Servo axis display name	ascii	0	255	
1112		5th Servo axis display name	ascii	0	255	
1142		1st Servo axis automatic system axis name	ascii	0	255	
1145		2nd Servo axis automatic system axis name	ascii	0	255	
1148		3rd Servo axis automatic system axis name	ascii	0	255	
1151		4th Servo axis automatic system axis name	ascii	0	255	
1154		5th Servo axis automatic system axis name	ascii	0	255	
5015	0	1st axis PLC control axis switch over		0	1	
	1	2nd axis PLC control axis switch over		0	1	
	2	3rd axis PLC control axis switch over		0	1	
	3	4th axis PLC control axis switch over		0	1	
	4	5th axis PLC control axis switch over		0	1	
5101		1st axis PLC axis control group		0	3	
5102		2nd axis PLC axis control group		0	3	
5103		3rd axis PLC axis control group		0	3	
5104		4th axis PLC axis control group		0	3	
5105		5th axis PLC axis control group		0	3	
6006	0	Axis disconnection 1st axis		0	1	
	1	Axis disconnection 2nd axis		0	1	
	2	Axis disconnection 3rd axis		0	1	
	4	Axis disconnection 5th axis		0	1	
	4	Axis disconnection 4th axis		0	1	

Contour Compensation

Address	Bit	Description	Register Units	Minimum Value	Maximum Value	Long Description
1781		1st axis contour compensation 2nd coefficient	0.001times	0	32767	
1782		2nd axis contour compensation 2nd coefficient	0.001times	0	32767	
1783		3rd axis contour compensation 2nd coefficient	0.001times	0	32767	
1784		4th axis contour compensation 2nd coefficient	0.001times	0	32767	
1785		5th axis contour compensation 2nd coefficient	0.001times	0	32767	
1800		G198 automatic switch acceleration limit	mm/sec2	0	32767	
1801		1st axis contour compensation coefficient	0.001times	0	32767	
1802		2nd axis contour compensation coefficient	0.001times	0	32767	
1803		3rd axis contour compensation coefficient	0.001times	0	32767	
1804		4th axis contour compensation coefficient	0.001times	0	32767	
1805		5th axis contour compensation coefficient	0.001times	0	32767	
2580		Cutting feedrate accel in contour compensation	mm/sec2	0	32768	Set multiple of 4
2581		Cutting feed S-curve in contour compensation		0	6	
4015	2	In-position check when contour compensation mode		0	1	
4031	3	GHSC accel/decel parameter use different as		0	1	
4169		G-HSC conversion mode type		0	2	
4171		G-HSC start command code	ascii	0	256	
4174		G-HSC end command code	ascii	0	256	
4807		G-HSC mode acceleration/ deceleration at corners	mm/sec2	0	32767	
4808		G-HSC mode acceleration/ deceleration at corners	mm/sec2	0	32767	
4809		G-HSC mode allowable acceleration in arc block	mm/sec2	0	32767	

Data In/Out

Address	Bit	Description	Register Units	Minimum Value	Maximum Value	Long Description
pm 7	6	"0" data in parameter output 1: "0" data is not output 0: "0" data is output		0	1	

Feed

Address	Bit	Description	Register Units	Minimum Value	Maximum Value	Long Description
pm2000	3	Setting of input unit for pm2447 (F0 feedrate) 1:% 0: mm/min		0	1	
pm2004	7	Inch mode rotary axis feed rate 1: F1.0 = 1.0deg/min 0: F1.0 = 10.0deg/min		0	1	
pm2444		Feedrate for rapid by external deceleration	mm/min	0	32767	
pm2445		Feedrate for cutting feed by external deceleration	mm/min	0	32767	
pm2501		1st axis accel/decel time constant in feed cut	msec	0	32767	
pm2502		2nd axis accel/decel time constant in feed	msec	0	32767	
pm2503		3rd axis accel/decel time constant in feed cut	msec	0	32767	
pm2504		4th axis accel/decel time constant in feed cut	msec	0	32767	
pm2505		5th axis accel/decel time constant in feed cut	msec	0	32767	
pm2511		1st axis accel/decel time constant in thread/tap	msec	0	32767	
pm2512		2nd axis accel/decel time constant in thread/tap	msec	0	32767	
pm2513		3rd axis accel/decel time constant in thread/tap	msec	0	32767	
pm2514		4th axis accel/decel time constant in thread/tap	msec	0	32767	
pm2515		5th axis accel/decel time constant in thread/tap	msec	0	32767	
pm2800		Maximum cutting feedrate (linear axis)	mm/min	0	240000	
pm2810		Maximum cutting feedrate (rotary axis)	deg/min	0	240000	
pm2821		1st axis bias in normal cutting accel/decel	mm/min, deg/min	0	240000	
pm2822		2nd axis bias in normal cutting accel/decel	mm/min, deg/min	0	240000	
pm2823		3rd axis bias in normal cutting accel/decel	mm/min, deg/min	0	240000	
pm2824		4th axis bias in normal cutting accel/decel	mm/min, deg/min	0	240000	
pm2825		5th axis bias in normal cutting accel/decel	mm/min, deg/min	0	240000	

F1 Digit

Address	Bit	Description	Register Units	Minimum Value	Maximum Value	Long Description
pm820		F1 digit feedrate (F1)	0.1mm/min	0	2400000	
pm821		F1 digit feedrate (F2)	0.1mm/min	0	2400000	
pm822		F1 digit feedrate (F3)	0.1mm/min	0	2400000	
pm823		F1 digit feedrate (F4)	0.1mm/min	0	2400000	
pm824		F1 digit feedrate (F5)	0.1mm/min	0	2400000	
pm825		F1 digit feedrate (F6)	0.1mm/min	0	2400000	
pm826		F1 digit feedrate (F7)	0.1mm/min	0	2400000	
pm827		F1 digit feedrate (F8)	0.1mm/min	0	2400000	
pm828		F1 digit feedrate (F9)	0.1mm/min	0	2400000	
pm2111		F1 command variation in feedrate/ gradation of HPG	0.1mm/min	0	255	
pm2112		F2 command variation in feedrate/ gradation of HPG	0.1mm/min	0	255	
pm2113		F3 command variation in feedrate/ gradation of HPG	0.1mm/min	0	255	
pm2114		F4 command variation in feedrate/ gradation of HPG	0.1mm/min	0	255	
pm2115		F5 command variation in feedrate/ gradation of	0.1mm/min	0	255	
pm2116		F6 command variation in feedrate/ gradation of HPG	0.1mm/min	0	255	
pm2117		F7 command variation in feedrate/ gradation of HPG	0.1mm/min	0	255	
pm2118		F8 command variation in feedrate/ gradation of HPG	0.1mm/min	0	255	
pm2119		F9 command variation in feedrate/ gradation of HPG	0.1mm/min	0	255	
pm2865		Maximum feedrate of F1 -digit (F1 - F4) command	mm/min, deg/min	0	240000	
pm2866		Maximum feedrate of F1 -digit (F 5 - F9) command	mm/min, deg/min	0	240000	

G Code

Address	Bit	Description	Register Units	Minimum Value	Maximum Value	Long Description
7	0	Selection of input unit 1: inch 0: mm		0	1	
803		Scaling multiple setting (1)	0.001	0	99999	Ratio = Scaling multiple setting (1)(pm0803) /Scaling multiple setting (2)(pm0804)
804		Scaling multiple setting (2)	0.001	0	1000000	Ratio = Scaling multiple setting (1)(pm0803) /Scaling multiple setting (2)(pm0804)
2862		Speed in high speed section during G12/G13	mm/min	0	240000	
4000	0	Selection of 01 G code group when power on / Reset 0: G00 1: G01		0	1	
	1	Selection of 03 G code group when power on 0: G90 1: G91		0	1	
	2	Selection of 04 G code group when power on 0: G98 1: G99		0	1	
	3	Selection of 08 G code group when power on 0: G49 1: G43 2: G44		0	2	
	5	Selection of 02 G code group when NC Reset 0: G17 1: G code specified immediately before the reset		0	1	
	6	Selection of 03 G code group when the NC reset 0: Default power on G code 1: G code specified immediately before Reset		0	1	
4012	6	Tool radius offset start-up and cancel spec type 0: YASNAC i / j type 1: YASNAC X type		0	1	

Address	Bit	Description	Register Units	Minimum Value	Maximum Value	Long Description
4013	0	Tool radius offset Start-up and cancel motion 1: A type 0: B type		0	1	
	1	Tool radius offset switching point of direction 1: Point of intersection switching at start and end. 0: Point of intersection		0	1	
	2	Tool radius offset process after the offset amount change 1: Valid from the start point 0: Valid from the completion point		0	1	
	3	Tool radius offset availability of interference check 1: Valid 0: Invalid		0	1	
	4	Tool radius offset process after detection of interference 1: Alarm 0: Automatic correction		0	1	
4014	0	1st axis Direction of G60 unidirectional positioning 1: Minus 0: Plus		0	1	
	1	2nd axis Direction of G60 unidirectional 1: Minus 0: Plus		0	1	
	2	3rd axis Direction of G60 unidirectional positioning 1: Minus 0: Plus		0	1	
	3	4th axis Direction of G60 unidirectional positioning 1: Minus 0: Plus		0	1	
	4	5th axis Direction of G60 unidirectional positioning 1: Minus 0: Plus		0	1	
4015	1	Allowable error range check for circular arc command 1: Checked 0: Not checked		0	1	
4450		Small arc skip value in tool radius compensation	0.001mm	0	32767	

Handle

Address	Bit	Description	Register Units	Minimum Value	Maximum Value	Long Description
pm2002	0	1st axis validity of automatic mode handle offset 1: Valid 0: Invalid		0	1	
	1	2nd axis validity of automatic mode handle offset 0: Invalid 1: Valid		0	1	
	2	3rd axis validity of automatic mode handle offset 1: Valid 0: Invalid		0	1	
	3	4th axis validity of automatic mode handle offset 1: Valid 0: Invalid		0	1	
	4	5th axis validity of automatic mode handle 0: Invalid 1: Valid		0	1	
pm2003	1	Valid operation of automatic mode handle 0: Other than rapid traverse 1: Only in the interpolation mode		0	1	
	7	Setting of x100 for manual pulse multiply 1: Value set for parameter (pm2459) 0: x100		0	1	
pm2561		1st axis accel/decel time constant in handle feed	msec	0	32767	Set multiple of 4
pm2562		2nd axis accel/decel time constant in handle feed	msec	0	32767	Set multiple of 4
pm2563		3rd axis accel/decel time constant in handle feed	msec	0	32767	Set multiple of 4
pm2564		4th axis accel/decel time constant in handle feed	msec	0	32767	Set multiple of 4
pm2565		5th axis accel/decel time constant in handle feed	msec	0	32767	Set multiple of 4
pm2860		Maximum feedrate in handle feed (linear axis)	mm/min	0	240000	
pm2861		Maximum feedrate in handle feed (rotary axis)	deg/min	0	240000	
pm2863		Lag pulses cramping value of handle	pulse	0	240000	Clamping process is not executed when "0" is set

High Speed Cutting

Address	Bit	Description	Register Units	Minimum Value	Maximum Value	Long Description
pm1200		Number of control axes during high speed mode		3	5	
pm1201		4th axis address name during high speed mode	ascii	0	255	
pm1202		5th axis address name during high speed mode	ascii	0	255	
pm2809		Maximum cutting feedrate in High speed mode	mm/min	0	2400000	
pm4030	0	Binary data for direct operation 0: Invalid 1: Valid		0	1	
pm4161		High speed conversion start command code	ascii	0	256	
pm4164		High speed conversion end command code	ascii	0	256	
pm4167		Segment type of high speed mode operation	msec	0	4	
pm4800		High speed mode acceleration/ deceleration at corners	mm/sec ²	0	32767	
pm4810		High-speed mode operation, acceleration/deceleration	mm/sec ²	0	32767	
pm4823		Allowable acceleration in arc block during high speed	mm/sec ²	0	32767	

I/O

Address	Bit	Description	Register Units	Minimum Value	Maximum Value	Long Description
pm905		Calendar output function, date setting No.1				
pm906		Calendar output function, date setting No.2				
pm907		Calendar output function, date setting No.3				
pm908		Calendar output function, date setting No.4				
pm1000	1	Spindle output when AFL signal is ON 1: S command is not accepted when AFL is 0: Output Spindle DA when AFL is ON in S		0	1	
	5	SSTP enable setting 1: SSTP enable when signal is 1 0: SSTP enable when signal is 0		0	1	SSTP setting for "0" output in response to "0" S command
pm1001	0	Output sign of S in S5-digit command 0: M03 + / M04 + 1: M03 - / M04 - 2: M03 + / M04 - 3: M03 - / M04 +		0	3	
pm1003	2	D/A output status is input to the PLC 0: Yes 1: No		0	1	
pm2000	4	Validity of feedrate override signal 0: Valid when "1" (A contact) 1: Valid when "0" (B contact)		0	1	
pm2400		JOG feedrate corresponding switch position 0	mm/min	0	32767	
pm2401		JOG feedrate corresponding switch position 1	mm/min	0	32767	
pm2402		JOG feedrate corresponding switch position 2	mm/min	0	32767	
pm2403		JOG feedrate corresponding switch position 3	mm/min	0	32767	
pm2404		JOG feedrate corresponding switch position 4	mm/min	0	32767	
pm2405		JOG feedrate corresponding switch position 5	mm/min	0	32767	
pm2406		JOG feedrate corresponding switch position 6	mm/min	0	32767	
pm2407		JOG feedrate corresponding switch position 7	mm/min	0	32767	

Address	Bit	Description	Register Units	Minimum Value	Maximum Value	Long Description
pm2408		JOG feedrate corresponding switch position 8	mm/min	0	32767	
pm2409		JOG feedrate corresponding switch position 9	mm/min	0	32767	
pm2410		JOG feedrate corresponding switch position 10	mm/min	0	32767	
pm2411		JOG feedrate corresponding switch position 11	mm/min	0	32767	
pm2412		JOG feedrate corresponding switch position 12	mm/min	0	32767	
pm2413		JOG feedrate corresponding switch position 13	mm/min	0	32767	
pm2414		JOG feedrate corresponding switch position 14	mm/min	0	32767	
pm2415		JOG feedrate corresponding switch position 15	mm/min	0	32767	
pm2416		JOG feedrate corresponding switch position 16	mm/min	0	32767	
pm2417		JOG feedrate corresponding switch position 17	mm/min	0	32767	
pm2418		JOG feedrate corresponding switch position 18	mm/min	0	32767	
pm2420		JOG feedrate corresponding switch position 20	mm/min	0	32767	
pm2421		JOG feedrate corresponding switch position 21	mm/min	0	32767	
pm2422		JOG feedrate corresponding switch position 22	mm/min	0	32767	
pm2423		JOG feedrate corresponding switch position 23	mm/min	0	32767	
pm2424		JOG feedrate corresponding switch position 24	mm/min	0	32767	
pm2425		JOG feedrate corresponding switch position 25	mm/min	0	32767	
pm2426		JOG feedrate corresponding switch position 26	mm/min	0	32767	
pm2427		JOG feedrate corresponding switch position 27	mm/min	0	32767	
pm2428		JOG feedrate corresponding switch position 28	mm/min	0	32767	
pm2429		JOG feedrate corresponding switch position 29	mm/min	0	32767	
pm2430		JOG feedrate corresponding switch position 30	mm/min	0	32767	

Address	Bit	Description	Register Units	Minimum Value	Maximum Value	Long Description
pm2431		JOG feedrate corresponding switch position 31	mm/min	0	32767	
pm2432		Multiply of jog feedrate parameter to 1, 10 or 100	times	0	100	
pm2433		Specify JOG switch position from which to multiply		0	31	When pm2432 not 0
pm2434		Specify JOG switch position from which to		0	31	If pm2433 and pm2434 are specified simultaneously, pm2433 has priority
pm2447		Feedrate of rapid feed override F0	mm/min	0	32767	1 = 1 mm/min (If pm2000 D3 = 0), 1 = 1% If pm2000 D3 = 1
pm2448		Feedrate of rapid feed override F1	%	0	100	
pm2449		Feedrate of rapid feed override F2	%	0	100	
pm2459		x100 Multiplication of Handle feed	times	0	32767	
pm4009	7	MST status when mode is changed auto to manual 0: MST are finished and SPL off 1: MST are saved with SPL on		0	1	
pm4015	0	Entry of program restart mode 0: By I/O 1: By soft-key		0	1	
pm5000	0	Valid timing of cycle start signal 1: Valid when "0" (B contact) 0: Valid when "1" (A contact)		0	1	
	1	Validity of Internal toggle switch 0: Invalid 1: Valid		0	1	
	2	Turning ON of RST output signal when ESP input signal is ON 0: Invalid 1: Valid		0	1	
pm5001	0	Selection of external data input data type 1: BCD 0: Binary		0	1	
pm5400		Time from base block cancel to brake release	msec	0	32767	
pm5401		Time from ESP signal rising to base block on	msec	0	32767	multiply of 10msec
pm5402		Time from ESP signal rising to base block on 2nd axis	msec	0	32767	multiply of 10msec
pm5403		Time from ESP signal rising to base block on 3rd axis	msec	0	32767	multiply of 10msec

Address	Bit	Description	Register Units	Minimum Value	Maximum Value	Long Description
pm5404		Time from ESP signal rising to base block on 4th axis	msec	0	32767	multiply of 10msec
pm5405		Time from ESP signal rising to base block on 5th axis	msec	0	32767	multiply of 10msec
pm5410		Time from sending M,S,T code to sending of MF,SF,TF	msec	0	32767	
pm5413		Parts counter keep memory address		0	7999	Parts counter use 2 bytes keep memory area
pm5420		Software switch, input keep memory start number		7000	7999	
pm5421		Software switch, output keep memory start number		7000	7999	
pm5426		Spindle tool number stored keep memory number		7000	7999	
pm5427		Program restart switch, keep memory number		7000	7999	
pm5428		Manual skip signal, keep memory number (work pre-setter)		7000	7999	
pm6130		No.1 position monitor, check axis number		0	5	
pm6131		No.2 position monitor, check axis number		0	5	
pm6132		No.3 position monitor, check axis number		0	5	
pm6133		No.4 position monitor, check axis number		0	1	
pm6134		No.5 position monitor, check axis number		0	5	
pm6135		No.6 position monitor, check axis number		0	5	
pm6136		No.7 position monitor, check axis number		0	5	
pm6137		No.8 position monitor, check axis number		0	5	
pm6920		No.1 position monitor forward dir area boundary value	0.001mm	-999999999	999999999	
pm6921		No.2 position monitor forward dir area boundary value	0.001mm	-999999999	999999999	
pm6922		No.3 position monitor forward dir area boundary value	0.001mm	-999999999	999999999	
pm6923		No.4 position monitor forward dir area boundary value	0.001mm	-999999999	999999999	
pm6924		No.5 position monitor forward dir area boundary value	0.001mm	-999999999	999999999	

Address	Bit	Description	Register Units	Minimum Value	Maximum Value	Long Description
pm6925		No.6 position monitor forward dir area boundary value	0.001mm	-999999999	999999999	
pm6926		No.7 position monitor forward dir area boundary value	0.001mm	-999999999	999999999	
pm6927		No.8 position monitor forward dir area boundary value	0.001mm	-999999999	999999999	
pm6930		No.1 position monitor reverse dir area boundary value	0.001mm	-999999999	999999999	
pm6931		No.2 position monitor reverse dir area boundary value	0.001mm	-999999999	999999999	
pm6932		No.3 position monitor reverse dir area boundary value	0.001mm	-999999999	999999999	
pm6933		No.4 position monitor reverse dir area boundary value	0.001mm	-999999999	999999999	
pm6934		No.5 position monitor reverse dir area boundary value	0.001mm	-999999999	999999999	
pm6935		No.6 position monitor reverse dir area boundary value	0.001mm	-999999999	999999999	
pm6936		No.7 position monitor reverse dir area boundary value	0.001mm	-999999999	999999999	
pm6937		No.8 position monitor reverse dir area boundary value	0.001mm	-999999999	999999999	

Jog

Address	Bit	Description	Register Units	Minimum Value	Maximum Value	Long Description
2000	7	Set JOG speed of rotary axis at 1/10 of linear 0: Not set at 1/10 1: Set at 1/10		0	1	

Linear Scale

Address	Bit	Description	Register Units	Minimum Value	Maximum Value	Long Description
1030	2	1st axis Separately installed PG 0: Invalid 1: Valid		0	1	
	4	1st axis Reverse connection of separately PG 0: Invalid 1: Valid		0	1	
1031	2	2nd axis Separately installed PG 0: Invalid 1: Valid		0	1	
	4	2nd axis Reverse connection of separately PG 0: Invalid 1: Valid		0	1	
1032	2	3rd axis Separately installed PG 0: Invalid 1: Valid		0	1	
	4	3rd axis Reverse connection of separately PG 0: Invalid 1: Valid		0	1	
1033	2	4th axis Separately installed PG 0: Invalid 1: Valid		0	1	
	4	4th axis Reverse connection of separately PG 0: Invalid 1: Valid		0	1	
1034	2	5th axis Separately installed PG 0: Invalid 1: Valid		0	1	
	4	5th axis Reverse connection of separately PG 0: Invalid 1: Valid		0	1	
1081	0	1st axis Externally installed encoder type 0: Linear scale 1: 15-bit ABS 2: 15-bit ABS (rotary axis) 3: 17-bit ABS 11: 8192 pulse new INC 18: 25000 pulse new INC 19: 30000 pulse new INC 23: 360000 pulse type for C-axis		0	255	

Address	Bit	Description	Register Units	Minimum Value	Maximum Value	Long Description
1082	0	2nd axis Externally installed encoder type 0: Linear scale 1: 15-bit ABS 2: 15-bit ABS (rotary axis) 3: 17-bit ABS 11: 8192 pulse new INC 18: 25000 pulse new INC 19: 30000 pulse new INC 23: 360000 pulse type for C-axis		0	255	
1083	0	3rd axis Externally installed encoder type 0: Linear scale 1: 15-bit ABS 2: 15-bit ABS (rotary axis) 3: 17-bit ABS 11: 8192 pulse new INC 18: 25000 pulse new INC 19: 30000 pulse new INC 23: 360000 pulse type for C-axis		0	255	
1084	0	4th axis Externally installed encoder type 0: Linear scale 1: 15-bit ABS 2: 15-bit ABS (rotary axis) 3: 17-bit ABS 11: 8192 pulse new INC 18: 25000 pulse new INC 19: 30000 pulse new INC 23: 360000 pulse type for C-axis		0	255	
1085	0	5th axis Externally installed encoder type 0: Linear scale 1: 15-bit ABS 2: 15-bit ABS (rotary axis) 3: 17-bit ABS 11: 8192 pulse new INC 18: 25000 pulse new INC 19: 30000 pulse new INC 23: 360000 pulse type for C-axis		0	255	
1841		1st axis separately PG, No. of pulses / motor rev	pulse	0	99999999	
1842		2nd axis separately PG, No. of pulses / motor rev	pulse	0	99999999	
1843		3rd axis separately PG, No. of pulses / motor rev	pulse	0	99999999	
1844		4th axis separately PG, No. of pulses / motor rev	pulse	0	99999999	
1845		5th axis separately PG, No. of pulses / motor rev	pulse	0	99999999	
1851		1st axis Virtual C phase distance	0.001deg	0	99999999	
1852		2nd axis Virtual C phase distance	0.001deg	0	99999999	

Address	Bit	Description	Register Units	Minimum Value	Maximum Value	Long Description
1853		3rd axis Virtual C phase distance	0.001deg	0	99999999	
1854		4th axis Virtual C phase distance	0.001deg	0	99999999	
1855		5th axis Virtual C phase distance	0.001deg	0	99999999	
4551		Virtual C-phase shift distance 1st axis	0.001mm	-32767	32767	
4552		Virtual C-phase shift distance 2nd axis	0.001mm	-32767	32767	
4553		Virtual C-phase shift distance 3rd axis	0.001mm	-32767	32767	
4554		Virtual C-phase shift distance 4th axis	0.001mm	-32767	32767	
4555		Virtual C-phase shift distance 5th axis	0.001mm	-32767	32767	

Machine Setup

Address	Bit	Description	Register Units	Minimum Value	Maximum Value	Long Description
7	2	Occurrence of alarm if no skip signal in skip block		0	1	Occurrence of an alarm if skip signal is not turned ON until the completion of axis move specified in the skip function block.
8	0	No. 2 stored stroke limit		0	1	
	1	No. 3 stored stroke limit		0	1	
	2	No. 4 stored stroke limit		0	1	
	3	No. 5 stored stroke limit		0	1	
	4	No. 2 entry prohibited area		0	1	
	5	No. 3 entry prohibited area		0	1	
	6	No. 4 entry prohibited area		0	1	
	7	No. 5 entry prohibited area		0	1	
420		Manual skip contact direction monitor No.1				Bit information D1: X+ D2:Y+ D3:Z+ D8:X- D9:Y- D10:Z-
421		Manual skip contact direction monitor No.2				Bit information D1: X+ D2:Y+ D3:Z+ D8:X- D9:Y- D10:Z-
422		Manual skip contact direction monitor No.3				Bit information D1: X+ D2:Y+ D3:Z+ D8:X- D9:Y- D10:Z-
423		Manual skip contact direction monitor No.4				Bit information D1: X+ D2:Y+ D3:Z+ D8:X- D9:Y- D10:Z-
424		Manual skip contact direction monitor No.5				Bit information D1: X+ D2:Y+ D3:Z+ D8:X- D9:Y- D10:Z-
831		No.2 stored stroke limit 1st axis (+)	0.001mm	-999999999	999999999	
832		No.2 stored stroke limit 2nd axis (+)	0.001mm	-999999999	999999999	
833		No.2 stored stroke limit 3rd axis (+)	0.001mm	-999999999	999999999	
834		No.2 stored stroke limit 1st axis (-)	0.001mm	-999999999	999999999	
835		No.2 stored stroke limit 2nd axis (-)	0.001mm	-999999999	999999999	
837		No.3 stored stroke limit 1st axis (+)	0.001mm	-999999999	999999999	
838		No.3 stored stroke limit 2nd axis (+)	0.001mm	-999999999	999999999	
839		No.3 stored stroke limit 3rd axis (+)	0.001mm	-999999999	999999999	
840		No.3 stored stroke limit 1st axis (-)	0.001mm	-999999999	999999999	
841		No.3 stored stroke limit 2nd axis (-)	0.001mm	-999999999	999999999	
842		No.3 stored stroke limit 3rd axis (-)	0.001mm	-999999999	999999999	

Address	Bit	Description	Register Units	Minimum Value	Maximum Value	Long Description
843		No.4 stored stroke limit 1st axis (+)	0.001mm	-999999999	999999999	
844		No.4 stored stroke limit 2nd axis (+)	0.001mm	-999999999	999999999	
845		No.4 stored stroke limit 3rd axis (+)	0.001mm	-999999999	999999999	
846		No.4 stored stroke limit 1st axis (-)	0.001mm	-999999999	999999999	
847		No.4 stored stroke limit 2nd axis (-)	0.001mm	-999999999	999999999	
848		No.4 stored stroke limit 3rd axis (-)	0.001mm	-999999999	999999999	
849		No.5 stored stroke limit 1st axis (+)	0.001mm	-999999999	999999999	
850		No.5 stored stroke limit 2nd axis (+)	0.001mm	-999999999	999999999	
851		No.5 stored stroke limit 3rd axis (+)	0.001mm	-999999999	999999999	
852		No.5 stored stroke limit 1st axis (-)	0.001mm	-999999999	999999999	
853		No.5 stored stroke limit 2nd axis (-)	0.001mm	-999999999	999999999	
854		No.5 stored stroke limit 3rd axis (-)	0.001mm	-999999999	999999999	
860		Deceleration feedrate by corner feedrate "mm"	mm/min	0	240000	Deceleration feedrate by corner feedrate designation function, "mm" mode (P)
861		Deceleration distance by corner feedrate "mm"	0.001mm	0	999999999	Deceleration distance by corner feedrate designation function, "mm" mode (L)
862		Deceleration feedrate by corner feedrate "inch"	0.1inch/min	0	94488	Deceleration feedrate by corner feedrate designation function, "inch" mode (P)
863		Deceleration distance by corner feedrate "inch"	0.0001inch	0	393700787	Deceleration distance by corner feedrate designation function, "inch" mode (L)
905		Calendar output function, date setting No.1				
906		Calendar output function, date setting No.2				
907		Calendar output function, date setting No.3				
908		Calendar output function, date setting No.4				
920		Manual skip position data, No.1 point 1st axis	0.001mm	-999999999	999999999	Manual skip position information, No.1 point (X-Z).
921		Manual skip position data, No.1 point 2nd axis	0.001mm	-999999999	999999999	Manual skip position information, No.1 point (X-Z).

Address	Bit	Description	Register Units	Minimum Value	Maximum Value	Long Description
922		Manual skip position data, No.1 point 3rd axis	0.001mm	-99999999	99999999	Manual skip position information, No.1 point (X-Z).
923		Manual skip position data, No.2 point 1st axis	0.001mm	-99999999	99999999	Manual skip position information, No.2 point (X-Z).
924		Manual skip position data, No.2 point 2nd axis	0.001mm	-99999999	99999999	Manual skip position information, No.2 point (X-Z).
925		Manual skip position data, No.2 point 3rd axis	0.001mm	-99999999	99999999	Manual skip position information, No.2 point (X-Z).
926		Manual skip position data, No.3 point 1st axis	0.001mm	-99999999	99999999	Manual skip position information, No.3 point (X-Z).
927		Manual skip position data, No.3 point 2nd axis	0.001mm	-99999999	99999999	Manual skip position information, No.3 point (X-Z).
928		Manual skip position data, No.3 point 3rd axis	0.001mm	-99999999	99999999	Manual skip position information, No.3 point (X-Z).
929		Manual skip position data, No.4 point 1st axis	0.001mm	-99999999	99999999	Manual skip position information, No.4 point (X-Z).
930		Manual skip position data, No.4 point 2nd axis	0.001mm	-99999999	99999999	Manual skip position information, No.4 point (X-Z).
931		Manual skip position data, No.4 point 3rd axis	0.001mm	-99999999	99999999	Manual skip position information, No.4 point (X-Z).
932		Manual skip position data, No.5 point 1st axis	0.001mm	-99999999	99999999	Manual skip position information, No.5 point (X-Z).
933		Manual skip position data, No.5 point 2nd axis	0.001mm	-99999999	99999999	Manual skip position information, No.5 point (X-Z).
934		Manual skip position data, No.5 point 3rd axis	0.001mm	-99999999	99999999	Manual skip position information, No.5 point (X-Z).
935		Manual skip position data, No.6 point 1st axis	0.001mm	-99999999	99999999	Manual skip position information, No.6 point (X-Z).
936		Manual skip position data, No.6 point 2nd axis	0.001mm	-99999999	99999999	Manual skip position information, No.6 point (X-Z).
937		Manual skip position data, No.6 point 3rd axis	0.001mm	-99999999	99999999	Manual skip position information, No.6 point (X-Z).

Address	Bit	Description	Register Units	Minimum Value	Maximum Value	Long Description
1000	1	Spindle output when AFL signal is ON		0	1	
	2	Override setting on spindle speed output		0	1	
	4	Filter for spindle load and speed		0	1	Filtering in the I/O output for the spindle load and speed monitor
	5	SSTP enable setting		0	1	SSTP setting for "0" output in response to "0" S command
	7	SAGR check when rapid to feed		0	1	Checking of SAGR when feed rate is changed from rapid to feed
1001	0	Output sign of S in S5-digit command		0	3	
1002	0	Magnification ratio of spindle speed		0	1	
1003	2	D/A output status is input to the PLC		0	1	
1020	0	1st axis YENET station number		0	15	1st Physical servo axis YENET1200 station number setting (No. 2 to No. 15 station)
	5	1st axis debug mode		0	1	
	6	1st axis Physical servo axis specifications		0	1	
	7	1st axis Physical servo axis enable		0	1	
1021	0	2nd axis YENET station number		0	15	2nd Physical servo axis YENET1200 station number setting (No. 2 to No. 15 station)
	5	2nd axis debug mode		0	1	
	6	2nd axis Physical servo axis specifications		0	1	
	7	2nd axis Physical servo axis enable		0	1	
1022	0	3rd axis YENET station number		0	15	3rd Physical servo axis YENET1200 station number setting (No. 2 to No. 15 station)
	5	3rd axis debug mode		0	1	
	6	3rd axis Physical servo axis specifications		0	1	
	7	3rd axis Physical servo axis enable		0	1	

Address	Bit	Description	Register Units	Minimum Value	Maximum Value	Long Description
1023	0	4th axis YENET station number		0	15	4th Physical servo axis YENET1200 station number setting (No. 2 to No. 15 station)
	5	4th axis debug mode		0	1	
	6	4th axis Physical servo axis specifications		0	1	
	7	4th axis Physical servo axis enable		0	1	
1024	0	5th axis YENET station number		0	15	5th Physical servo axis YENET1200 station number setting (No. 2 to No. 15 station)
	5	5th axis debug mode		0	1	
	6	5th axis Physical servo axis specifications		0	1	
	7	5th axis Physical servo axis enable		0	1	
1026	0	1st spindle YENET number		0	15	No.1 physical spindle YENET1200 station number setting (No. 2 to No. 15 station)
	5	1st spindle debug mode		0	1	
	6	1st physical spindle specifications		0	1	
	7	1st physical spindle enable		0	1	
1030	0	1st axis Velocity loop control method		0	1	
	1	1st axis Velocity loop control automatic		0	1	
	2	1st axis Separately installed PG		0	1	
	4	1st axis Reverse connection of separately PG		0	1	
	6	1st axis Axis type		0	1	
	7	1st axis Servo Motor rotation direction		0	1	

Address	Bit	Description	Register Units	Minimum Value	Maximum Value	Long Description
1031	0	2nd axis Velocity loop control method		0	1	
	1	2nd axis Velocity loop control automatic		0	1	
	2	2nd axis Separately installed PG		0	1	
	4	2nd axis Reverse connection of separately PG		0	1	
	6	2nd axis Axis type		0	1	
	7	2nd axis Servo Motor rotation direction		0	1	
1032	0	3rd axis Velocity loop control method		0	1	
	1	3rd axis Velocity loop control automatic setting		0	1	
	2	3rd axis Separately installed PG		0	1	
	4	3rd axis Reverse connection of separately PG		0	1	
	6	3rd axis Axis type		0	1	
	7	3rd axis Servo Motor rotation direction		0	1	
1033	0	4th axis Velocity loop control method		0	1	
	1	4th axis Velocity loop control automatic setting		0	1	
	2	4th axis Separately installed PG		0	1	
	4	4th axis Reverse connection of separately PG		0	1	
	6	4th axis Axis type		0	1	
	7	4th axis Servo Motor rotation direction		0	1	
1034	0	5th axis Velocity loop control method		0	1	
	1	5th axis Velocity loop control automatic setting		0	1	
	2	5th axis Separately installed PG		0	1	
	4	5th axis Reverse connection of separately PG		0	1	
	6	5th axis Axis type		0	1	
	7	5th axis Servo Motor rotation direction		0	1	

Address	Bit	Description	Register Units	Minimum Value	Maximum Value	Long Description
1039	1	Spindle servo control type		0	2	
	5	Spindle servo control enable		0	1	
	7	Spindle servo control configuration		0	1	
1044	0	1st axis Servo feed amount change		0	1	
	1	1st axis Absolute encoder		0	1	
	2	1st axis Disregarding error pulse at emergency stop		0	1	
	3	1st axis Follow-up processing for servo OFF		0	1	
	4	1st axis Use of absolute encoder		0	1	
	5	1st axis Zero return Virtual C phase motor 1 rev		0	1	
	6	1st axis Infinite length for rotary axis control		0	1	
	7	1st axis Use of 17-bit encoder		0	1	
1045	0	2nd axis Servo feed amount change		0	1	
	1	2nd axis Absolute encoder		0	1	
	2	2nd axis Disregarding error pulse at emergency		0	1	
	3	2nd axis Follow-up processing for servo OFF		0	1	
	4	2nd axis Use of absolute encoder		0	1	
	5	2nd axis Zero return Virtual C phase motor 1 rev		0	1	
	6	2nd axis Infinite length for rotary axis control		0	1	
	7	2nd axis Use of 17-bit encoder		0	1	
1046	0	3rd axis Servo feed amount change		0	1	
	1	3rd axis Absolute encoder		0	1	
	2	3rd axis Disregarding error pulse at emergency stop		0	1	
	3	3rd axis Follow-up processing for servo OFF		0	1	
	4	3rd axis Use of absolute encoder		0	1	
	5	3rd axis Zero return Virtual C phase motor 1 rev		0	1	
	6	3rd axis Infinite length for rotary axis		0	1	
	7	3rd axis Use of 17-bit encoder		0	1	

Address	Bit	Description	Register Units	Minimum Value	Maximum Value	Long Description
1047	0	4th axis Servo feed amount change		0	1	
	1	4th axis Absolute encoder		0	1	
	2	4th axis Disregarding error pulse at emergency stop		0	1	
	3	4th axis Follow-up processing for servo OFF		0	1	
	4	4th axis Use of absolute encoder		0	1	
	5	4th axis Zero return Virtual C phase motor 1 rev		0	1	
	6	4th axis Infinite length for rotary axis control		0	1	
	7	4th axis Use of 17-bit encoder		0	1	
1048	0	5th axis Servo feed amount change		0	1	
	1	5th axis Absolute encoder		0	1	
	2	5th axis Disregarding error pulse at emergency stop		0	1	
	3	5th axis Follow-up processing for servo OFF		0	1	
	4	5th axis Use of absolute encoder		0	1	
	5	5th axis Zero return Virtual C phase motor 1		0	1	
	6	5th axis Infinite length for rotary axis control		0	1	
	7	5th axis Use of 17-bit encoder		0	1	
1053	2	Execution of spindle indexing in loop control		0	1	
	3	C-axis indexing when switching to C-axis		0	1	
1061	0	Setting of motor selection code for 1st axis		0	255	
1062	0	Setting of motor selection code for 2nd axis		0	255	
1063	0	Setting of motor selection code for 3rd axis		0	255	
1064	0	Setting of motor selection code for 4th axis		0	255	
1065	0	Setting of motor selection code for 5th axis		0	255	

Address	Bit	Description	Register Units	Minimum Value	Maximum Value	Long Description
1070	0	External torque observer 1st axis		0	1	Availability of digital amplifier offset external torque observer
	1	External torque observer 2nd axis		0	1	Availability of digital amplifier offset external torque observer
	2	External torque observer 3rd axis		0	1	Availability of digital amplifier offset external torque observer
	3	External torque observer 4th axis		0	1	Availability of digital amplifier offset external torque observer
	4	External torque observer 5th axis		0	1	Availability of digital amplifier offset external torque observer
1071	0	1st axis motor encoder type		0	255	
1072	0	2nd axis motor encoder type		0	255	
1073	0	3rd axis motor encoder type		0	255	
1074	0	4th axis motor encoder type		0	255	
1075	0	5th axis motor encoder type		0	255	
1080	0	1st axis roundness irregularity compensation		0	1	
	1	2nd axis roundness irregularity compensation		0	1	
	2	3rd axis roundness irregularity compensation		0	1	
	3	4th axis roundness irregularity compensation		0	1	
	4	5th axis roundness irregularity compensation		0	1	
1081	0	1st axis Externally installed encoder type		0	255	
1082	0	2nd axis Externally installed encoder type		0	255	
1083	0	3rd axis Externally installed encoder type		0	255	
1084	0	4th axis Externally installed encoder type		0	255	
1085	0	5th axis Externally installed encoder type		0	255	
1091	0	Spindle encoder type		0	255	

Address	Bit	Description	Register Units	Minimum Value	Maximum Value	Long Description
1096	0	1st axis Servo Damping control		0	1	
	1	2nd axis Servo Damping control		0	1	
	2	3rd axis Servo Damping control		0	1	
	3	4th axis Servo Damping control		0	1	
	4	5th axis Servo Damping control		0	1	
1097	0	1st axis Reduced vibration when servo stop		0	1	
	1	2nd axis Reduced vibration when servo stop		0	1	
	2	3rd axis Reduced vibration when servo stop		0	1	
	3	4th axis Reduced vibration when servo stop		0	1	
	4	5th axis Reduced vibration when servo stop		0	1	
1100		1st Servo axis display name	ascii	0	255	
1103		2nd Servo axis display name	ascii	0	255	
1106		3rd Servo axis display name	ascii	0	255	
1109		4th Servo axis display name	ascii	0	255	
1112		5th Servo axis display name	ascii	0	255	
1127		Spindle display name	ascii	0	255	
1142		1st Servo axis automatic system axis name	ascii	0	255	
1145		2nd Servo axis automatic system axis name	ascii	0	255	
1148		3rd Servo axis automatic system axis name	ascii	0	255	
1151		4th Servo axis automatic system axis name	ascii	0	255	
1154		5th Servo axis automatic system axis name	ascii	0	255	
1169		Spindle automatic system axis name	ascii	0	255	
1200		Number of control axes during high speed mode		3	5	
1201		4th axis address name during high speed mode	ascii	0	255	
1202		5th axis address name during high speed mode	ascii	0	255	
1220		Spindle index confirmation timer	8msec	1	255	
1225		Spindle index stopped confirmation revolutions	r/min	1	255	

Address	Bit	Description	Register Units	Minimum Value	Maximum Value	Long Description
1226		Spindle index stopped confirmation revolutions B	r/min	1	255	Spindle index stopped confirmation revolutions at selection of spindle gear B-axis
1240		Spindle number for executing solid tap		0	1	
1241		Servo axis number for executing solid tap		1	5	
1252		Return feedrate multiplication for solid tap	0.1times	1	255	
1260		Spindle loop control gear number (A)		0	4	
1261		Spindle loop control gear number (B)		0	4	
1321		1st axis Error detect-On area	0.001mm	0	255	
1322		2nd axis Error detect-On area	0.001mm	0	255	
1323		3rd axis Error detect-On area	0.001mm	0	255	
1324		4th axis Error detect-On area	0.001mm	0	255	
1325		5th axis Error detect-On area	0.001mm	0	255	
1331		Error detect-ON area during spindle loop control	0.001mm	0	255	
1332		Error detect-ON area during spindle loop control B	0.001mm	0	255	
1351		Servo error range when spindle loop control	%	0	255	Spindle, Multiplication relative to rapid feed in servo error range
1352		Servo error range when spindle loop control	%	0	255	Spindle, Multiplication relative to rapid feed in servo error range for gear B
1371		1st axis Reduced vibration level when servo stop	%	0	100	
1372		2nd axis Reduced vibration level when servo stop	%	0	100	
1373		3rd axis Reduced vibration level when servo stop	%	0	100	
1374		4th axis Reduced vibration level when servo stop	%	0	100	
1375		5th axis Reduced vibration level when servo stop	%	0	100	
1400		Minimum spindle revolution clamp for gear 1	r/min	0	30000	
1401		Minimum spindle revolution clamp for gear 2	r/min	0	30000	

Address	Bit	Description	Register Units	Minimum Value	Maximum Value	Long Description
1402		Minimum spindle revolution clamp for gear 3	r/min	0	30000	
1403		Minimum spindle revolution clamp for gear 4	r/min	0	30000	
1404		Maximum spindle revolution clamp for gear 1	r/min	0	30000	
1405		Maximum spindle revolution clamp for gear 2	r/min	0	30000	
1406		Maximum spindle revolution clamp for gear 3	r/min	0	30000	
1407		Maximum spindle revolution clamp for gear 4	r/min	0	30000	
1408		Spindle max motor speed for gear 1	r/min	0	30000	
1409		Spindle max motor speed for gear 2	r/min	0	30000	
1410		Spindle max motor speed for gear 3	r/min	0	30000	
1411		Spindle max motor speed for gear 4	r/min	0	30000	
1412		Spindle speed when spindle orientation (SOR) on	r/min	0	32767	
1413		Spindle speed when spindle gear shift (SRO) on	r/min	0	32767	
1414		Spindle indexing origin position	360/ 4096deg	0	4095	
1415		Spindle, max speed corresponding to 10V	r/min	0	32767	
1416		Maximum spindle speed during solid tap	r/min	0	32767	
1417		Spindle position loop gain for solid tap	0.01[1/S]	0	32767	
1418		Spindle C-axis, max speed corresponding to 10V	r/min	0	666	Maximum spindle speed corresponding to 10 V of command (C-axis is used)
1419		Spindle gear A base speed	r/min	0	32767	
1435		Spindle, max speed corresponding to 10V (Gear B)	r/min	0	32767	
1436		Maximum spindle speed during solid tap (Gear B)	r/min	0	32767	
1437		Spindle position loop gain for solid tap (Gear B)	0.01[1/S]	0	32767	
1439		Spindle gear B base speed	r/min	0	32767	
1500		Solid tap servo shaft retraction in-position width	0.001mm	0	32767	

Address	Bit	Description	Register Units	Minimum Value	Maximum Value	Long Description
1502		Solid tap synchronization offset parameter K1		-32767	32767	
1503		Solid tap synchronization offset parameter K2		-32767	32767	
1506		Rotary tool spindle sync offset parameter K1		-32767	32676	
1507		Rotary tool spindle sync offset parameter K2		-32767	32676	
1510		No. of teeth of gear A on the spindle side	tooth	0	32767	No. of teeth of gear A on the spindle side for spindle loop control
1511		No. of teeth of gear A on the spindle	tooth	0	32767	No. of teeth of the spindle intermediate gear A used for spindle loop control
1512		No. of teeth of gear A on the motor intermediate	tooth	0	32767	No. of teeth of the motor intermediate gear A used for spindle loop control If there is no intermediate gear, set 0
1513		No. of teeth of gear A on the motor side intermediate	tooth	0	32767	No. of teeth on the motor side of gear A used for spindle loop control If there is no intermediate gear, set 0
1514		No. of teeth of gear B on the spindle side intermediate	tooth	0	32767	No. of teeth of gear B on the spindle side for spindle loop control If there is no intermediate gear, set motor side one
1515		No. of teeth of gear B on the spindle intermediate	tooth	0	32767	No. of teeth of the spindle intermediate gear B used for spindle loop control If there is no intermediate gear, set 0
1516		No. of teeth of gear B on the motor intermediate	tooth	0	32767	No. of teeth of the motor intermediate gear B used for spindle loop control If there is no intermediate gear, set 0
1517		No. of teeth of gear B on the motor side	tooth	0	32767	No. of teeth on the motor side of gear B used for spindle loop control
1540		Delay time to check the SAGR signal	msec	0	32767	If there is no intermediate gear, set 0
1551		1st axis backlash compensation amount	0.1micron	0	32767	

Address	Bit	Description	Register Units	Minimum Value	Maximum Value	Long Description
1552		2nd axis backlash compensation amount	0.1micron	0	32767	
1553		3rd axis backlash compensation amount	0.1micron	0	32767	
1554		4th axis backlash compensation amount	0.1micron	0	32767	
1555		5th axis backlash compensation amount	0.1micron	0	32767	
1561		1st axis No of teeth of monitor when servo feed change	tooth	1	255	
1562		2nd axis No of teeth of monitor when servo feed change	tooth	0	255	
1563		3rd axis No of teeth of monitor when servo feed change	tooth	0	255	
1564		4th axis No of teeth of monitor when servo feed change	tooth	0	255	
1565		5th axis No of teeth of monitor when servo feed change	tooth	0	255	
1571		1st axis No of teeth of screw side when servo feed change	tooth	0	255	
1572		2nd axis No of teeth of screw side when servo feed change	tooth	0	255	
1573		3rd axis No of teeth of screw side when servo feed change	tooth	0	255	
1574		4th axis No of teeth of screw side when servo feed change	tooth	0	255	
1575		5th axis No of teeth of screw side when servo feed change	tooth	0	255	
1580		1st axis Position loop gain Kp	0.01[1/S]	500	20000	
1581		1st axis Velocity loop gain Kv	0.1[1/S]	350	32767	
1582		1st axis Speed loop integration time constant Ti	0.01msec	26	32767	
1583		1st axis Second position loop gain Kp	0.01[1/S]	500	20000	
1584		1st axis Speed feed forward gain Kvfff	%	0	100	
1585		1st axis Second velocity loop gain Kv	0.1[1/S]	350	32767	
1586		1st axis First step axis torsion filter time constant Tn	0.01msec	1	32767	
1587		1st axis Second step axis torsion filter time constant Tn	0.01msec	1	32767	
1588		1st axis Third step axis torsion filter time constant Tn	0.01msec	1	32767	

Address	Bit	Description	Register Units	Minimum Value	Maximum Value	Long Description
1589		1st axis Monitor board signal selection, multiplication		0	32767	
1590		2nd axis Position loop gain Kp	0.01[1/S]	500	20000	
1591		2nd axis Velocity loop gain Kv	0.1[1/S]	350	32767	
1592		2nd axis Speed loop integration time constant Ti	0.01msec	26	32767	
1593		2nd axis Second position loop gain Kp	0.01[1/S]	500	20000	
1594		2nd axis Speed feed forward gain Kvfff	%	0	100	
1595		2nd axis Second velocity loop gain Kv	0.1[1/S]	350	32767	
1596		2nd axis First step axis torsion filter time	0.01msec	1	32767	
1597		2nd axis Second step axis torsion filter time constant Tn	0.01msec	1	32767	
1598		2nd axis Third step axis torsion filter time constant Tn	0.01msec	1	32767	
1599		2nd axis Monitor board signal selection, multiplication		0	32767	
1600		3rd axis Position loop gain Kp	0.01[1/S]	500	20000	
1601		3rd axis Velocity loop gain Kv	0.1[1/S]	350	32767	
1602		3rd axis Speed loop integration time constant	0.01msec	26	32767	
1603		3rd axis Second position loop gain Kp	0.01[1/S]	500	20000	
1604		3rd axis Speed feed forward gain Kvfff	%	0	100	
1605		3rd axis Second velocity loop gain Kv	0.1[1/S]	350	32767	
1606		3rd axis First step axis torsion filter time constant Tn	0.01msec	1	32767	
1607		3rd axis Second step axis torsion filter time constant Tn	0.01msec	1	32767	
1608		3rd axis Third step axis torsion filter time constant Tn	0.01msec	1	32767	
1609		3rd axis Monitor board signal selection, multiplication		0	32767	
1610		4th axis Position loop gain Kp	0.01[1/S]	500	20000	
1611		4th axis Velocity loop gain Kv	0.1[1/S]	350	32767	
1612		4th axis Speed loop integration time constant Ti	0.01msec	26	32767	

Address	Bit	Description	Register Units	Minimum Value	Maximum Value	Long Description
1613		4th axis Second position loop gain Kp	0.01[1/S]	500	20000	
1614		4th axis Speed feed forward gain Kvfff	%	0	100	
1615		4th axis Second velocity loop gain Kv	0.1[1/S]	350	32767	
1616		4th axis First step axis torsion filter time constant Tn	0.01msec	1	32767	
1617		4th axis Second step axis torsion filter time	0.01msec	1	32767	
1618		4th axis Third step axis torsion filter time constant Tn	0.01msec	1	32767	
1619		4th axis Monitor board signal selection, multiplication		0	32767	
1620		5th axis Position loop gain Kp	0.01[1/S]	500	20000	
1621		5th axis Velocity loop gain Kv	0.1[1/S]	350	32767	
1622		5th axis Speed loop integration time constant Ti	0.01msec	26	32767	
1623		5th axis Second position loop gain Kp	0.01[1/S]	500	20000	
1624		5th axis Speed feed forward gain Kvfff	%	0	100	
1625		5th axis Second velocity loop gain Kv	0.1[1/S]	350	32767	
1626		5th axis First step axis torsion filter time constant Tn	0.01msec	1	32767	
1627		5th axis Second step axis torsion filter time constant Tn	0.01msec	1	32767	
1628		5th axis Third step axis torsion filter time constant Tn	0.01msec	1	32767	
1629		5th axis Monitor board signal selection, multiplication		0	32767	
1641		1st axis Variable in position check No1 area	0.001mm	0	32767	
1642		2nd axis Variable in position check No1 area	0.001mm	0	32767	
1643		3rd axis Variable in position check No1 area	0.001mm	0	32767	
1644		4th axis Variable in position check No1 area	0.001mm	0	32767	
1645		5th axis Variable in position check No1 area	0.001mm	0	32767	
1651		1st axis Variable in position check No2 area	0.001mm	0	32767	For caned cycle and solid tap

Address	Bit	Description	Register Units	Minimum Value	Maximum Value	Long Description
1652		2nd axis Variable in position check No2 area	0.001mm	0	32767	For caned cycle and solid tap
1653		3rd axis Variable in position check No2 area	0.001mm	0	32767	For caned cycle and solid tap
1654		4th axis Variable in position check No2 area	0.001mm	0	32767	For caned cycle and solid tap
1655		5th axis Variable in position check No2 area	0.001mm	0	32767	For caned cycle and solid tap
1671		1st axis torque limit value (+)	%	1	32767	
1672		2nd axis torque limit value (+)	%	0	32767	
1673		3rd axis torque limit value (+)	%	0	32767	
1674		4th axis torque limit value (+)	%	0	32767	
1675		5th axis torque limit value (+)	%	0	32767	
1681		1st axis Servo Damping, observer time constant	Hz	0	32767	
1682		2nd axis Servo Damping, observer time constant	Hz	0	32767	
1683		3rd axis Servo Damping, observer time constant	Hz	0	32767	
1684		4th axis Servo Damping, observer time constant	Hz	0	32767	
1685		5th axis Servo Damping, observer time constant	Hz	0	32767	
1701		1st axis Servo Damping, load inertia fine	%	0	10000	
1702		2nd axis Servo Damping, load inertia fine adjust	%	0	10000	
1703		3rd axis Servo Damping, load inertia fine adjust	%	0	10000	
1704		4th axis Servo Damping, load inertia fine adjust	%	0	10000	
1705		5th axis Servo Damping, load inertia fine adjust	%	0	10000	
1711		1st axis backlash time constant	0.01msec	0	32767	
1712		2nd axis backlash time constant	0.01msec	0	32767	
1713		3rd axis backlash time constant	0.01msec	0	32767	
1714		4th axis backlash time constant	0.01msec	0	32767	
1715		5th axis backlash time constant	0.01msec	0	32767	
1751		1st axis Servo Damping, high pass filter time const	micro sec	0	32767	

Address	Bit	Description	Register Units	Minimum Value	Maximum Value	Long Description
1752		2nd axis Servo Damping, high pass filter time const	micro sec	0	32767	
1753		3rd axis Servo Damping, high pass filter time const	micro sec	0	32767	
1754		4th axis Servo Damping, high pass filter time const	micro sec	0	32767	
1755		5th axis Servo Damping, high pass filter time const	micro sec	0	32767	
1781		1st axis contour compensation 2nd coefficient	0.001times	0	32767	
1782		2nd axis contour compensation 2nd coefficient	0.001times	0	32767	
1783		3rd axis contour compensation 2nd coefficient	0.001times	0	32767	
1784		4th axis contour compensation 2nd coefficient	0.001times	0	32767	
1785		5th axis contour compensation 2nd coefficient	0.001times	0	32767	
1791		1st axis Servo Damping, low pass filter time const	micro sec	0	32767	
1792		2nd axis Servo Damping, low pass filter time const	micro sec	0	32767	
1793		3rd axis Servo Damping, low pass filter time const	micro sec	0	32767	
1794		4th axis Servo Damping, low pass filter time const	micro sec	0	32767	
1795		5th axis Servo Damping, low pass filter time const	micro sec	0	32767	
1800		G198 automatic switch acceleration limit	mm/sec ²	0	32767	
1801		1st axis contour compensation coefficient	0.001times	0	32767	
1802		2nd axis contour compensation coefficient	0.001times	0	32767	
1803		3rd axis contour compensation coefficient	0.001times	0	32767	
1804		4th axis contour compensation coefficient	0.001times	0	32767	
1805		5th axis contour compensation coefficient	0.001times	0	32767	
1811		1st axis Servo Damping, compensation gain	%	-2000	2000	
1812		2nd axis Servo Damping, compensation gain	%	-2000	2000	

Address	Bit	Description	Register Units	Minimum Value	Maximum Value	Long Description
1813		3rd axis Servo Damping, compensation gain	%	-2000	2000	
1814		4th axis Servo Damping, compensation gain	%	-2000	2000	
1815		5th axis Servo Damping, compensation gain	%	-2000	2000	
1821		1st axis Motion amount or table rotation angle/motor rev	0.001mm	0	999999999	
1822		2nd axis Motion amount or table rotation angle/motor rev	0.001mm	0	999999999	
1823		3rd axis Motion amount or table rotation angle/motor rev	0.001mm	0	999999999	
1824		4th axis Motion amount or table rotation angle/motor rev	0.001mm	0	999999999	
1825		5th axis Motion amount or table rotation angle/motor rev	0.001mm	0	999999999	
1831		1st axis load inertia	%	0	32767	
1832		2nd axis load inertia	%	0	32767	
1833		3rd axis load inertia	%	0	32767	
1834		4th axis load inertia	%	0	32767	
1835		5th axis load inertia	%	0	32767	
1841		1st axis separately PG, No. of pulses / motor rev	pulse	0	999999999	
1842		2nd axis separately PG, No. of pulses / motor rev	pulse	0	999999999	
1843		3rd axis separately PG, No. of pulses / motor	pulse	0	999999999	
1844		4th axis separately PG, No. of pulses / motor rev	pulse	0	999999999	
1845		5th axis separately PG, No. of pulses / motor rev	pulse	0	999999999	
1851		1st axis Virtual C phase distance	0.001deg	0	999999999	
1852		2nd axis Virtual C phase distance	0.001deg	0	999999999	
1853		3rd axis Virtual C phase distance	0.001deg	0	999999999	
1854		4th axis Virtual C phase distance	0.001deg	0	999999999	
1855		5th axis Virtual C phase distance	0.001deg	0	999999999	

Address	Bit	Description	Register Units	Minimum Value	Maximum Value	Long Description
2000	0	Dry run during fast feed		0	1	
	1	Dry run during thread cutting		0	1	
	3	Setting of input unit for pm2447 (F0 feedrate)		0	1	
	4	Validity of feedrate override signal		0	1	
	6	Replacing RAPID reverse with JOG until Zero		0	1	
	7	Set JOG speed of rotary axis at 1/10 of linear		0	1	
2001	0	Feedrate for skip function		0	1	
	7	Variable in position check		0	1	
2002	0	1st axis validity of automatic mode handle offset		0	1	
	1	2nd axis validity of automatic mode handle offset		0	1	
	2	3rd axis validity of automatic mode handle offset		0	1	
	3	4th axis validity of automatic mode handle offset		0	1	
	4	5th axis validity of automatic mode handle offset		0	1	
2003	1	Valid operation of automatic mode handle		0	1	
	7	Setting of x100 for manual pulse multiply		0	1	
2004	7	Inch mode rotary axis feed rate		0	1	
2005	0	G00 interpolation mode		0	1	
2400		JOG feedrate corresponding switch position 0	mm/min	0	32767	
2401		JOG feedrate corresponding switch position 1	mm/min	0	32767	
2402		JOG feedrate corresponding switch position 2	mm/min	0	32767	
2403		JOG feedrate corresponding switch position 3	mm/min	0	32767	
2404		JOG feedrate corresponding switch position 4	mm/min	0	32767	
2405		JOG feedrate corresponding switch position 5	mm/min	0	32767	
2406		JOG feedrate corresponding switch position 6	mm/min	0	32767	

Address	Bit	Description	Register Units	Minimum Value	Maximum Value	Long Description
2407		JOG feedrate corresponding switch position 7	mm/min	0	32767	
2408		JOG feedrate corresponding switch position 8	mm/min	0	32767	
2409		JOG feedrate corresponding switch position 9	mm/min	0	32767	
2410		JOG feedrate corresponding switch position 10	mm/min	0	32767	
2411		JOG feedrate corresponding switch position 11	mm/min	0	32767	
2412		JOG feedrate corresponding switch position 12	mm/min	0	32767	
2413		JOG feedrate corresponding switch position 13	mm/min	0	32767	
2414		JOG feedrate corresponding switch position 14	mm/min	0	32767	
2415		JOG feedrate corresponding switch position 15	mm/min	0	32767	
2416		JOG feedrate corresponding switch position 16	mm/min	0	32767	
2417		JOG feedrate corresponding switch position 17	mm/min	0	32767	
2418		JOG feedrate corresponding switch position 18	mm/min	0	32767	
2419		JOG feedrate corresponding switch position 19	mm/min	0	32767	
2420		JOG feedrate corresponding switch position 20	mm/min	0	32767	
2421		JOG feedrate corresponding switch position 21	mm/min	0	32767	
2422		JOG feedrate corresponding switch position 22	mm/min	0	32767	
2423		JOG feedrate corresponding switch position 23	mm/min	0	32767	
2424		JOG feedrate corresponding switch position 24	mm/min	0	32767	
2425		JOG feedrate corresponding switch position 25	mm/min	0	32767	
2426		JOG feedrate corresponding switch position 26	mm/min	0	32767	
2427		JOG feedrate corresponding switch position 27	mm/min	0	32767	
2428		JOG feedrate corresponding switch position 28	mm/min	0	32767	

Address	Bit	Description	Register Units	Minimum Value	Maximum Value	Long Description
2429		JOG feedrate corresponding switch position 29	mm/min	0	32767	
2430		JOG feedrate corresponding switch position 30	mm/min	0	32767	
2431		JOG feedrate corresponding switch position 31	mm/min	0	32767	
2432		Multiply of jog feedrate parameter to 1, 10 or 100	times	0	100	
2433		Specify JOG switch position from which to multiply		0	31	When pm2432 not 0
2434		Specify JOG switch position from which to 10-Jan		0	31	If pm2433 and pm2434 are specified simultaneously, pm2433 has priority.
2440		Speed during execution of skip	mm/min	0	32767	
2444		Feedrate for rapid by external deceleration	mm/min	0	32767	
2445		Feedrate for cutting feed by external deceleration	mm/min	0	32767	
2447		Feedrate of rapid feed override F0	mm/min	0	32767	1 = 1 mm/min (If pm2000 D3 = 0), 1 = 1% (If pm2000 D3 = 1)
2448		Feedrate of rapid feed override F1	%	0	100	
2449		Feedrate of rapid feed override F2	%	0	100	
2458		Rapid feed bias value	%	0	100	
2459		x100 Multiplication of Handle feed	times	0	32767	
2461		1st axis rapid feed accel/decel time constant	msec	0	32767	Set multiple of 4
2462		2nd axis rapid feed accel/decel time constant	msec	0	32767	Set multiple of 4
2463		3rd axis rapid feed accel/decel time constant	msec	0	32767	Set multiple of 4
2464		4th axis rapid feed accel/decel time constant	msec	0	32767	Set multiple of 4
2465		5th axis rapid feed accel/decel time constant	msec	4	32767	Set multiple of 4
2471		Spindle accel/decel time constant	msec	0	32767	Set multiple of 4
2472		Spindle accel/decel time constant (gear B)	msec	0	32767	Set multiple of 4
2481		1st axis backlash compensation amount in G01	0.1micron	-32767	32767	
2482		2nd axis backlash compensation amount in G01 mode	0.1micron	-32767	32767	

Address	Bit	Description	Register Units	Minimum Value	Maximum Value	Long Description
2483		3rd axis backlash compensation amount in G01 mode	0.1micron	-32767	32767	
2484		4th axis backlash compensation amount in G01 mode	0.1micron	-32767	32767	
2485		5th axis backlash compensation amount in G01 mode	0.1micron	-32767	32767	
2491		1st axis backlash compensation amount in Handle	0.1micron	-32767	32767	
2492		2nd axis backlash compensation amount in Handle	0.1micron	-32767	32767	
2493		3rd axis backlash compensation amount in Handle	0.1micron	-32767	32767	
2494		4th axis backlash compensation amount in Handle	0.1micron	-32767	32767	
2495		5th axis backlash compensation amount in Handle	0.1micron	-32767	32767	
2501		1st axis accel/decel time constant in feed cut	msec	0	32767	
2502		2nd axis accel/decel time constant in feed cut	msec	0	32767	
2503		3rd axis accel/decel time constant in feed cut	msec	0	32767	
2504		4th axis accel/decel time constant in feed cut	msec	0	32767	
2505		5th axis accel/decel time constant in feed cut	msec	0	32767	
2511		1st axis accel/decel time constant in thread/tap	msec	0	32767	
2512		2nd axis accel/decel time constant in thread/tap	msec	0	32767	
2513		3rd axis accel/decel time constant in thread/tap	msec	0	32767	
2514		4th axis accel/decel time constant in thread/tap	msec	0	32767	
2515		5th axis accel/decel time constant in thread/tap	msec	0	32767	
2521		1st axis reference point return approach speed	mm/min, deg/min	0	32767	
2522		2nd axis reference point return approach speed	mm/min, deg/min	0	32767	
2523		3rd axis reference point return approach speed	mm/min, deg/min	0	32767	
2524		4th axis reference point return approach speed	mm/min, deg/min	0	32767	

Address	Bit	Description	Register Units	Minimum Value	Maximum Value	Long Description
2525		5th axis reference point return approach speed	mm/min, deg/min	0	32767	
2531		1st axis reference point return creep speed	mm/min, deg/min	0	32767	
2532		2nd axis reference point return creep speed	mm/min, deg/min	0	32767	
2533		3rd axis reference point return creep speed	mm/min, deg/min	0	32767	
2534		4th axis reference point return creep speed	mm/min, deg/min	0	32767	
2535		5th axis reference point return creep speed	mm/min, deg/min	0	32767	
2541		Spindle index starting speed	r/min	1	32767	
2542		Spindle index starting speed when gear B	r/min	0	32767	
2546		Spindle index creeping speed	r/min	0	32767	
2547		Spindle index creeping speed when gear B	r/min	0	32767	
2551		Max spindle motor speed	r/min	0	32767	
2561		1st axis accel/decel time constant in handle feed	msec	0	32767	Set multiple of 4
2562		2nd axis accel/decel time constant in handle feed	msec	0	32767	Set multiple of 4
2563		3rd axis accel/decel time constant in handle feed	msec	0	32767	Set multiple of 4
2564		4th axis accel/decel time constant in handle feed	msec	0	32767	Set multiple of 4
2565		5th axis accel/decel time constant in handle	msec	0	32767	Set multiple of 4
2571		1st axis accel/decel time constant in No2 G00 mode	msec	0	32767	Set multiple of 4
2572		2nd axis accel/decel time constant in No2 G00 mode	msec	0	32767	Set multiple of 4
2573		3rd axis accel/decel time constant in No2 G00 mode	msec	0	32767	Set multiple of 4
2574		4th axis accel/decel time constant in No2 G00 mode	msec	0	32767	Set multiple of 4
2575		5th axis accel/decel time constant in No2 G00 mode	msec	0	32767	Set multiple of 4
2580		Cutting feedrate accel in contour	mm/sec ²	0	32768	Set multiple of 4
2581		Cutting feed S-curve in contour compensation		0	6	

Address	Bit	Description	Register Units	Minimum Value	Maximum Value	Long Description
2591		1st axis rapid feed accel/decel S-curve		0	20	
2592		2nd axis rapid feed accel/decel S-curve		0	20	
2593		3rd axis rapid feed accel/decel S-curve		0	20	
2594		4th axis rapid feed accel/decel S-curve		0	20	
2595		5th axis rapid feed accel/decel S-curve		0	20	
2601		1st axis rapid feed accel/decel S-curve in 2nd S		0	15	
2602		2nd axis rapid feed accel/decel S-curve in 2nd S		0	15	
2603		3rd axis rapid feed accel/decel S-curve in 2nd S		0	15	
2604		4th axis rapid feed accel/decel S-curve in 2nd S		0	15	
2605		5th axis rapid feed accel/decel S-curve in 2nd S		0	15	
2800		Maximum cutting feedrate (linear axis)	mm/min	0	240000	
2801		1st axis Rapid feed rate	mm/min	0	240000	
2802		2nd axis Rapid feed rate	mm/min	0	240000	
2803		3rd axis Rapid feed rate	mm/min	0	240000	
2804		4th axis Rapid feed rate	mm/min	0	240000	
2805		5th axis Rapid feed rate	mm/min	0	240000	
2809		Maximum cutting feedrate in High speed mode	mm/min	0	2400000	
2810		Maximum cutting feedrate (rotary axis)	deg/min	0	240000	
2811		1st axis rapid feed rate in 2nd S-curve accel/decel	mm/min, deg/min	0	240000	
2812		2nd axis rapid feed rate in 2nd S-curve	mm/min, deg/min	0	240000	
2813		3rd axis rapid feed rate in 2nd S-curve accel/decel	mm/min, deg/min	0	240000	
2814		4th axis rapid feed rate in 2nd S-curve accel/decel	mm/min, deg/min	0	240000	
2815		5th axis rapid feed rate in 2nd S-curve accel/decel	mm/min, deg/min	0	240000	
2821		1st axis bias in normal cutting accel/decel	mm/min, deg/min	0	240000	

Address	Bit	Description	Register Units	Minimum Value	Maximum Value	Long Description
2822		2nd axis bias in normal cutting accel/decel	mm/min, deg/min	0	240000	
2823		3rd axis bias in normal cutting accel/decel	mm/min, deg/min	0	240000	
2824		4th axis bias in normal cutting accel/decel	mm/min, deg/min	0	240000	
2825		5th axis bias in normal cutting accel/decel	mm/min, deg/min	0	240000	
2831		1st axis bias in thread cutting accel/decel	mm/min, deg/min	0	240000	
2832		2nd axis bias in thread cutting accel/decel	mm/min, deg/min	0	240000	
2833		3rd axis bias in thread cutting accel/decel	mm/min, deg/min	0	240000	
2834		4th axis bias in thread cutting accel/decel	mm/min, deg/min	0	240000	
2835		5th axis bias in thread cutting accel/decel	mm/min, deg/min	0	240000	
2851		1st axis second G00 feedrate	mm/min, deg/min	0	240000	
2852		2nd axis second G00 feedrate	mm/min, deg/min	0	240000	
2853		3rd axis second G00 feedrate	mm/min, deg/min	0	240000	
2854		4th axis second G00 feedrate	mm/min, deg/min	0	240000	
2855		5th axis second G00 feedrate	mm/min, deg/min	0	240000	
2860		Maximum feedrate in handle feed (linear axis)	mm/min	0	240000	
2861		Maximum feedrate in handle feed (rotary axis)	deg/min	0	240000	
2863		Lag pulses cramping value of handle	pulse	0	240000	Clamping process is not executed when "0" is set
4001	6	Occurrence of Alarm cycle start before Zero return		0	1	Conforms to pm4018 d0-d4
4002	0	1st axis Reference point return direction		0	1	
4002	1	2nd axis Reference point return direction		0	1	
4002	2	3rd axis Reference point return direction		0	1	
4002	3	4th axis Reference point return direction		0	1	

Address	Bit	Description	Register Units	Minimum Value	Maximum Value	Long Description
4002	4	5th axis Reference point return direction		0	1	
4003	6	Manual Zero return type in 2nd and later		0	1	
4003	7	Auto mode Zero return type in 2nd and later		0	1	
4004	0	Alarm occur if axis move command before ZRN 1st axis		0	1	Occurrence of alarm if movement command other than G28 is executed without carrying out manual or automatic reference point return for 1st axis
4004	1	Alarm occur if axis move command before ZRN 2nd axis		0	1	Occurrence of alarm if movement command other than G28 is executed without carrying out manual or automatic reference point return for 2nd axis
4004	2	Alarm occur if axis move command before ZRN 3rd axis		0	1	Occurrence of alarm if movement command other than G28 is executed without carrying out manual or automatic reference point return for 3rd axis
4004	3	Alarm occur if axis move command before ZRN 4th axis		0	1	Occurrence of alarm if movement command other than G28 is executed without carrying out manual or automatic reference point return for 4th axis
4004	4	Alarm occur if axis move command before ZRN 5th axis		0	1	Occurrence of alarm if movement command other than G28 is executed without carrying out manual or automatic reference point return for 5th axis
4009	7	MST status when mode is changed auto to manual		0	1	

Address	Bit	Description	Register Units	Minimum Value	Maximum Value	Long Description
4015	0	Entry of program restart mode		0	1	
	2	In-position check when contour compensation mode		0	1	
	3	In-position check at the completion of G04		0	0	
	4	In-position check when G code is changed to G00		0	1	
	5	G00 error detection during solid tap		0	1	
	6	Display peak value of synchronization error in solid tap		0	1	
4018	0	1st axis alarm occur when cycle start		0	1	
	1	2nd axis alarm occur when cycle start without ZRN		0	1	
	2	3rd axis alarm occur when cycle start without ZRN		0	1	
	3	4th axis alarm occur when cycle start without ZRN		0	1	
	4	5th axis alarm occur when cycle start without ZRN		0	1	
4022	0	1st axis validity of reference point return		0	1	
	1	2nd axis validity of reference point return		0	1	
	2	3rd axis validity of reference point return		0	1	
	3	4th axis validity of reference point return		0	1	
	4	5th axis validity of reference point return		0	1	
4030	0	Binary data for direct operation		0	1	
4031	3	GHSC accel/decel parameter use different as SHSC		0	1	
4161		High speed conversion start command code	ascii	0	256	
4164		High speed conversion end command code	ascii	0	256	
4167		Segment type of high speed mode operation	msec	0	4	
4169		G-HSC conversion mode type		0	2	
4171		G-HSC start command code	ascii	0	256	
4174		G-HSC end command code	ascii	0	256	

Address	Bit	Description	Register Units	Minimum Value	Maximum Value	Long Description
4451		1st axis reference point return traverse distance	0.001mm	0	32767	
4452		2nd axis reference point return traverse distance	0.001mm	0	32767	
4453		3rd axis reference point return traverse distance	0.001mm	0	32767	
4454		4th axis reference point return traverse distance	0.001mm	0	32767	
4455		5th axis reference point return traverse distance	0.001mm	0	32767	
4461		1st axis overtravel distance in G60	0.001mm	0	32767	
4462		2nd axis overtravel distance in G60	0.001mm	0	32767	
4463		3rd axis overtravel distance in G60	0.001mm	0	32767	
4464		4th axis overtravel distance in G60	0.001mm	0	32767	
4465		5th axis overtravel distance in G60	0.001mm	0	32767	
4551		Virtual C-phase shift distance 1st axis	0.001mm	-32767	32767	
4552		Virtual C-phase shift distance 2nd axis	0.001mm	-32767	32767	
4553		Virtual C-phase shift distance 3rd axis	0.001mm	-32767	32767	
4554		Virtual C-phase shift distance 4th axis	0.001mm	-32767	32767	
4555		Virtual C-phase shift distance 5th axis	0.001mm	-32767	32767	
4800		High speed mode acceleration/ deceleration at	mm/sec ²	0	32767	
4807		G-HSC mode acceleration/ deceleration	mm/sec ²	0	32767	
4808		G-HSC mode acceleration/ deceleration at corners	mm/sec ²	0	32767	
4809		G-HSC mode allowable acceleration in arc block	mm/sec ²	0	32767	
4810		High-speed mode operation, acceleration/deceleration	mm/sec ²	0	32767	
4820		Allowable error range when arc radius is specified	0.001mm	0	999999999	
4823		Allowable acceleration in arc block during	mm/sec ²	0	32767	

Address	Bit	Description	Register Units	Minimum Value	Maximum Value	Long Description
5000	0	Valid timing of cycle start signal		0	1	
	1	Validity of Internal toggle switch		0	1	
	2	Turning ON of RST output signal when ESP input signal is ON		0	1	
5001	0	Selection of external data input data type		0	1	
5010	0	Skip signal		0	1	
	5	Skip sensor monitor ON signal timing		0	1	
	7	Manual skip B function		0	1	
5011	0	Valid timing of skip signal		0	1	
5015	0	1st axis PLC control axis switch over		0	1	
	1	2nd axis PLC control axis switch over		0	1	
	2	3rd axis PLC control axis switch over		0	1	
	3	4th axis PLC control axis switch over		0	1	
	4	5th axis PLC control axis switch over		0	1	
5018	0	Gear selection of H gear		0	2	
	2	Gear selection of M gear		0	2	
	4	Gear selection of L gear		0	2	
5101		1st axis PLC axis control group		0	3	
5102		2nd axis PLC axis control group		0	3	
5103		3rd axis PLC axis control group		0	3	
5104		4th axis PLC axis control group		0	3	
5105		5th axis PLC axis control group		0	3	
6000	0	Pitch error compensation 1st axis		0	1	
	1	Pitch error compensation 2nd axis		0	1	
	2	Pitch error compensation 3rd axis		0	1	
	3	Pitch error compensation 4th axis		0	1	
	4	Pitch error compensation 5th axis		0	1	
6001	0	Setting of compensation data for pitch error		0	1	

Address	Bit	Description	Register Units	Minimum Value	Maximum Value	Long Description
6002	0	No.1 stored stroke limit check 1st axis execution		0	1	
	1	No.1 stored stroke limit check 2nd axis execution		0	1	
	2	No.1 stored stroke limit check 3rd axis execution		0	1	
	3	No.1 stored stroke limit check 4th axis execution		0	1	
	4	No.1 stored stroke limit check 5th axis execution		0	1	
6004	0	Execution of stored stroke limit check for rotary 1st axis		0	1	
	1	Execution of stored stroke limit check for rotary 2nd axis		0	1	
	2	Execution of stored stroke limit check for rotary 3rd axis		0	1	
	3	Execution of stored stroke limit check for rotary 4th axis		0	1	
	4	Execution of stored stroke limit check for rotary 5th axis		0	1	
6006	0	Axis disconnection 1st axis		0	1	
	1	Axis disconnection 2nd axis		0	1	
	2	Axis disconnection 3rd axis		0	1	
	4	Axis disconnection 4th axis		0	1	
	4	Axis disconnection 5th axis		0	1	
6101		1st axis, pitch error compensation multiplication		0	3	
6102		2nd axis, pitch error compensation multiplication		0	3	
6103		3rd axis, pitch error compensation multiplication		0	3	
6104		4th axis, pitch error compensation multiplication		0	3	
6105		5th axis, pitch error compensation multiplication		0	3	
6111		No.2 stored stroke limit check 1st axis		0	5	
6112		No.2 stored stroke limit check 2nd axis		0	5	
6113		No.2 stored stroke limit check 3rd axis		0	5	
6114		No.3 stored stroke limit check 1st axis		0	5	

Address	Bit	Description	Register Units	Minimum Value	Maximum Value	Long Description
6115		No.3 stored stroke limit check 2nd axis		0	5	
6116		No.3 stored stroke limit check 3rd axis		0	5	
6117		No.4 stored stroke limit check 1st axis		0	5	
6118		No.4 stored stroke limit check 2nd axis		0	5	
6119		No.4 stored stroke limit check 3rd axis		0	5	
6120		No.5 stored stroke limit check 1st axis		0	5	
6121		No.5 stored stroke limit check 2nd axis		0	5	
6122		No.5 stored stroke limit check 3rd axis		0	5	
6401		1st axis, pitch error start memory number		0	1151	
6402		2nd axis, pitch error start memory number		0	1151	
6403		3rd axis, pitch error start memory number		0	1151	
6404		4th axis, pitch error start memory number		0	1151	
6405		5th axis, pitch error start memory number		0	1151	
6411		1st axis, pitch error completion memory number		0	1151	
6412		2nd axis, pitch error completion memory number		0	1151	
6413		3rd axis, pitch error completion memory number		0	1151	
6414		4th axis, pitch error completion memory number		0	1151	
6415		5th axis, pitch error completion memory number		0	1151	
6421		1st axis, pitch error reference point memory number		0	1151	
6422		2nd axis, pitch error reference point memory number		0	1151	
6423		3rd axis, pitch error reference point memory number		0	1151	
6424		4th axis, pitch error reference point memory number		0	1151	

Address	Bit	Description	Register Units	Minimum Value	Maximum Value	Long Description
6425		5th axis, pitch error reference point memory number		0	1151	
6801		1st axis, pitch error compensation intervals	0.001mm	0	999999999	
6802		2nd axis, pitch error compensation intervals	0.001mm	0	999999999	
6803		3rd axis, pitch error compensation intervals	0.001mm	0	999999999	
6804		4th axis, pitch error compensation intervals	0.001mm	0	999999999	
6805		5th axis, pitch error compensation intervals	0.001mm	0	999999999	
6811		1st axis, second reference point position	0.001mm	-999999999	999999999	
6812		2nd axis, second reference point position	0.001mm	-999999999	999999999	
6813		3rd axis, second reference point position	0.001mm	-999999999	999999999	
6814		4th axis, second reference point position	0.001mm	-999999999	999999999	
6815		5th axis, second reference point position	0.001mm	-999999999	999999999	
6821		1st axis, third reference point position	0.001mm	-999999999	999999999	
6822		2nd axis, third reference point position	0.001mm	-999999999	999999999	
6823		3rd axis, third reference point position	0.001mm	-999999999	999999999	
6824		4th axis, third reference point position	0.001mm	-999999999	999999999	
6825		5th axis, third reference point position	0.001mm	-999999999	999999999	
6831		1st axis, fourth reference point position	0.001mm	-999999999	999999999	
6832		2nd axis, fourth reference point position	0.001mm	-999999999	999999999	
6833		3rd axis, fourth reference point position	0.001mm	-999999999	999999999	
6834		4th axis, fourth reference point position	0.001mm	-999999999	999999999	
6835		5th axis, fourth reference point position	0.001mm	-999999999	999999999	
6861		1st axis, pitch error compensation stroke (maximum)	0.001mm	-999999999	999999999	

Address	Bit	Description	Register Units	Minimum Value	Maximum Value	Long Description
6862		2nd axis, pitch error compensation stroke (maximum)	0.001mm	-999999999	999999999	
6863		3rd axis, pitch error compensation stroke (maximum)	0.001mm	-999999999	999999999	
6864		4th axis, pitch error compensation stroke (maximum)	0.001mm	-999999999	999999999	
6865		5th axis, pitch error compensation stroke (maximum)	0.001mm	-999999999	999999999	
6871		1st axis, pitch error compensation stroke (minimum)	0.001mm	-999999999	999999999	
6872		2nd axis, pitch error compensation stroke (minimum)	0.001mm	-999999999	999999999	
6873		3rd axis, pitch error compensation stroke (minimum)	0.001mm	-999999999	999999999	
6874		4th axis, pitch error compensation stroke (minimum)	0.001mm	-999999999	999999999	
6875		5th axis, pitch error compensation stroke (minimum)	0.001mm	-999999999	999999999	
6881		1st axis, pitch error comp reference point position	0.001mm	-999999999	999999999	
6882		2nd axis, pitch error comp reference point position	0.001mm	-999999999	999999999	
6883		3rd axis, pitch error comp reference point position	0.001mm	-999999999	999999999	
6884		4th axis, pitch error comp reference point position	0.001mm	-999999999	999999999	
6885		5th axis, pitch error comp reference point position	0.001mm	-999999999	999999999	
6901		No.1 stored stroke limit 1st axis (+)	0.001mm	-999999999	999999999	
6902		No.1 stored stroke limit 2nd axis (+)	0.001mm	-999999999	999999999	
6903		No.1 stored stroke limit 3rd axis (+)	0.001mm	-999999999	999999999	
6904		No.1 stored stroke limit 4th axis (+)	0.001mm	-999999999	999999999	
6905		No.1 stored stroke limit 5th axis (+)	0.001mm	-999999999	999999999	
6911		No.1 stored stroke limit 1st axis (-)	0.001mm	-999999999	999999999	
6912		No.1 stored stroke limit 2nd axis (-)	0.001mm	-999999999	999999999	
6913		No.1 stored stroke limit 3rd axis (-)	0.001mm	-999999999	999999999	
6914		No.1 stored stroke limit 4th axis (-)	0.001mm	-999999999	999999999	
6915		No.1 stored stroke limit 5th axis (-)	0.001mm	-999999999	999999999	

Address	Bit	Description	Register Units	Minimum Value	Maximum Value	Long Description
8000	0	Absolute motor zero return condition 1st axis		0	1	
	1	Absolute motor zero return condition 2nd axis		0	1	
	2	Absolute motor zero return condition 3rd axis		0	1	
	3	Absolute motor zero return condition 4th axis		0	1	
	4	Absolute motor zero return condition 5th axis		0	1	
8001	0	Absolute motor position gap condition 1st axis		0	1	
	1	Absolute motor position gap condition 2nd axis		0	1	
	2	Absolute motor position gap condition 3rd axis		0	1	
	3	Absolute motor position gap condition 4th axis		0	1	
	4	Absolute motor position gap condition 5th axis		0	1	
8002	0	Absolute motor zero return type		0	3	
8401		1st axis, fine adjust amount in zero point setting		-32767	32767	
8402		2nd axis, fine adjust amount in zero point setting		-32767	32767	
8403		3rd axis, fine adjust amount in zero point setting		-32767	32767	
8404		4th axis, fine adjust amount in zero point setting		-32767	32767	
8405		5th axis, fine adjust amount in zero point setting		-32767	32767	
8411		1st axis, position gap distance limit when power on		0	32767	
8412		2nd axis, position gap distance limit when power on		0	32767	
8413		3rd axis, position gap distance limit when power on		0	32767	
8414		4th axis, position gap distance limit when power on		0	32767	
8415		5th axis, position gap distance limit when power on		0	32767	
8471		1st axis (- to +) roundness irregularity Integral constant	msec	0	32767	

Address	Bit	Description	Register Units	Minimum Value	Maximum Value	Long Description
8472		2nd axis (- to +) roundness irregularity Integral constant	msec	0	32767	
8473		3rd axis (- to +) roundness irregularity Integral constant	msec	0	32767	
8474		4th axis (- to +) roundness irregularity Integral constant	msec	0	32767	
8475		5th axis (- to +) roundness irregularity Integral constant	msec	0	32767	
8481		1st axis (- to +) roundness irregularity completion torque	0.01%	0	20000	
8482		2nd axis (- to +) roundness irregularity completion torque	0.01%	0	20000	
8483		3rd axis (- to +) roundness irregularity completion torque	0.01%	0	20000	
8484		4th axis (- to +) roundness irregularity completion torque	0.01%	0	20000	
8485		5th axis (- to +) roundness irregularity	0.01%	0	20000	
8491		1st axis roundness irregularity Timing parameter	0.01[1/S]	-32767	32767	
8492		2nd axis roundness irregularity Timing parameter	0.01[1/S]	-32767	32767	
8493		3rd axis roundness irregularity Timing parameter	0.01[1/S]	-32767	32767	
8494		4th axis roundness irregularity Timing parameter	0.01[1/S]	-32767	32767	
8495		5th axis roundness irregularity Timing parameter	0.01[1/S]	-32767	32767	
8501		1st axis (+ to -) roundness irregularity Integral constant	msec	0	32767	
8502		2nd axis (+ to -) roundness irregularity Integral constant	msec	0	32767	
8503		3rd axis (+ to -) roundness irregularity Integral constant	msec	0	32767	
8504		4th axis (+ to -) roundness irregularity Integral constant	msec	0	32767	
8505		5th axis (+ to -) roundness irregularity Integral constant	msec	0	32767	
8511		1st axis (+ to -) roundness irregularity completion torque	0.01%	0	20000	
8512		2nd axis (+ to -) roundness irregularity completion torque	0.01%	0	20000	
8513		3rd axis (+ to -) roundness irregularity completion torque	0.01%	0	20000	

Address	Bit	Description	Register Units	Minimum Value	Maximum Value	Long Description
8514		4th axis (+ to -) roundness irregularity completion torque	0.01%	0	20000	
8515		5th axis (+ to -) roundness irregularity completion torque	0.01%	0	20000	
8521		1st axis roundness irregularity weight compensation torque	0.01%	-12000	12000	
8522		2nd axis roundness irregularity weight compensation torque	0.01%	-12000	12000	
8523		3rd axis roundness irregularity weight compensation torque	0.01%	-12000	12000	
8524		4th axis roundness irregularity weight compensation torque	0.01%	-12000	12000	
8525		5th axis roundness irregularity weight compensation torque	0.01%	-12000	12000	
8801		1st axis, power off machine position	0.001mm	-999999999	999999999	
8802		2nd axis, power off machine position	0.001mm	-999999999	999999999	
8803		3rd axis, power off machine position	0.001mm	-999999999	999999999	
8804		4th axis, power off machine position	0.001mm	-999999999	999999999	
8805		5th axis, power off machine position	0.001mm	-999999999	999999999	
8811		1st axis, offset amount in zero point setting	pulse	-999999999	999999999	
8812		2nd axis, offset amount in zero point setting	pulse	-999999999	999999999	
8813		3rd axis, offset amount in zero point setting	pulse	-999999999	999999999	
8814		4th axis, offset amount in zero point setting	pulse	-999999999	999999999	
8815		5th axis, offset amount in zero point setting	pulse	-999999999	999999999	
8821		1st axis, shift amount in zero point setting	0.001mm	-999999999	999999999	
8822		2nd axis, shift amount in zero point setting	0.001mm	-999999999	999999999	
8823		3rd axis, shift amount in zero point setting	0.001mm	-999999999	999999999	
8824		4th axis, shift amount in zero point setting	0.001mm	-999999999	999999999	
8825		5th axis, shift amount in zero point setting	0.001mm	-999999999	999999999	

Macro Program

Address	Bit	Description	Register Units	Minimum Value	Maximum Value	Long Description
7	1	Single block in Macro		0	1	Operation instructions and control instructions in user macro.
20	0	Macro edit/display lock for O8000		0	1	Edit, display, and input/output operation of part programs O8000 to O8999
21	0	Macro edit lock for O8000		0	1	Edit, input/output operation of part programs O8000 to O8999
22	0	Macro edit lock for O9000		0	1	Edit, input/output operation of part programs O9000 to O9999
3004	0	Edit/display/output of O9000 to O9999 program		0	1	
4009	0	Macro system value #5001 at execute G31 skip		0	1	
	1	Macro variables #100 - #299 become empty by ????		0	1	
	2	Output leading zeros at DPRINT		0	1	
	3	Macro system value #1100-#1132 when reset		0	1	
4480		G code macro 1 call G code		0	999	
4481		G code macro 2 call G code		0	999	
4482		G code macro 3 call G code		0	999	
4483		G code macro 4 call G code		0	999	
4484		G code macro 5 call G code		0	999	
4485		G code macro 6 call G code		0	999	
4486		G code macro 7 call G code		0	999	
4487		G code macro 8 call G code		0	999	
4488		G code macro 9 call G code		0	999	
4489		G code macro 10 call G code		0	999	
4490		G code macro 11 call G code		0	999	
4491		G code macro 12 call G code		0	999	
4492		G code macro 13 call G code		0	999	
4493		G code macro 14 call G code		0	999	
4494		G code macro 15 call G code		0	999	
4495		G code macro 16 call G code		0	999	
4496		G code macro 17 call G code		0	999	

Address	Bit	Description	Register Units	Minimum Value	Maximum Value	Long Description
4497		G code macro 18 call G code		0	999	
4498		G code macro 19 call G code		0	999	
4499		G code macro 20 call G code		0	999	
4500		G code macro 21 call G code		0	999	
4501		G code macro 22 call G code		0	999	
4502		G code macro 23 call G code		0	999	
4503		G code macro 24 call G code		0	999	
4504		M code macro 1 call M code		0	999	
4505		M code macro 2 call M code		0	999	
4506		M code macro 3 call M code		0	999	
4507		M code macro 4 call M code		0	999	
4508		M code macro 5 call M code		0	999	
4509		M code macro 6 call M code		0	999	
4510		M code macro 7 call M code		0	999	
4511		M code macro 8 call M code		0	999	
4512		M code macro 9 call M code		0	999	
4513		M code macro 10 call M code		0	999	
4514		M code macro 11 call M code		0	999	
4515		M code macro 12 call M code		0	999	
4516		M code macro 13 call M code		0	999	
4517		M code macro 14 call M code		0	999	
4518		M code macro 15 call M code		0	999	
4519		M code macro 16 call M code		0	999	
4520		M code macro 17 call M code		0	999	
4521		M code macro 18 call M code		0	999	
4522		M code macro 19 call M code		0	999	
4523		M code macro 20 call M code		0	999	
4524		M code macro 21 call M code		0	999	
4525		M code macro 22 call M code		0	999	
4526		M code macro 23 call M code		0	999	
4527		M code macro 24 call M code		0	999	
4840		G code macro 1 call program number		0	99999	
4841		G code macro 2 call program number		0	99999	

Address	Bit	Description	Register Units	Minimum Value	Maximum Value	Long Description
4842		G code macro 3 call program number		0	99999	
4843		G code macro 4 call program number		0	99999	
4844		G code macro 5 call program number		0	99999	
4845		G code macro 6 call program number		0	99999	
4846		G code macro 7 call program number		0	99999	
4847		G code macro 8 call program number		0	99999	
4848		G code macro 9 call program number		0	99999	
4849		G code macro 10 call program number		0	99999	
4850		G code macro 11 call program number		0	99999	
4851		G code macro 12 call program number		0	99999	
4852		G code macro 13 call program number		0	99999	
4853		G code macro 14 call program number		0	99999	
4854		G code macro 15 call program number		0	99999	
4855		G code macro 16 call program number		0	99999	
4856		G code macro 17 call program number		0	99999	
4857		G code macro 18 call program number		0	99999	
4858		G code macro 19 call program number		0	99999	
4859		G code macro 20 call program number		0	99999	
4860		G code macro 21 call program number		0	99999	
4861		G code macro 22 call program number		0	99999	
4862		G code macro 23 call program number		0	99999	
4863		G code macro 24 call program number		0	99999	

Address	Bit	Description	Register Units	Minimum Value	Maximum Value	Long Description
4864		M code macro 1 call program number		0	99999	
4865		M code macro 2 call program number		0	99999	
4866		M code macro 3 call program number		0	99999	
4867		M code macro 4 call program number		0	99999	
4868		M code macro 5 call program number		0	99999	
4869		M code macro 6 call program number		0	99999	
4870		M code macro 7 call program number		0	99999	
4871		M code macro 8 call program number		0	99999	
4872		M code macro 9 call program number		0	99999	
4873		M code macro 10 call program number		0	99999	
4874		M code macro 11 call program number		0	99999	
4875		M code macro 12 call program number		0	99999	
4876		M code macro 13 call program number		0	99999	
4877		M code macro 14 call program number		0	99999	
4878		M code macro 15 call program number		0	99999	
4879		M code macro 16 call program number		0	99999	
4880		M code macro 17 call program number		0	99999	
4881		M code macro 18 call program number		0	99999	
4882		M code macro 19 call program number		0	99999	
4883		M code macro 20 call program number		0	99999	
4884		M code macro 21 call program number		0	99999	
4885		M code macro 22 call program number		0	99999	

Address	Bit	Description	Register Units	Minimum Value	Maximum Value	Long Description
4886		M code macro 23 call program number		0	99999	
4887		M code macro 24 call program number		0	99999	
4888		S code macro call program number		0	99999	
4889		T code macro call program number		0	99999	
4890		B code macro call program number		0	99999	

Parameter Measurement

Address	Bit	Description	Register Units	Minimum Value	Maximum Value	Long Description
806		Tool length measurement bias amount	0.001mm	-999999999	999999999	
807		Tool length measurement bottom level	0.001mm	-999999999	999999999	
3001	3	Simplified TLM 0: Valid 1: Invalid		0	1	
5012	1	Measuring by work/offset presetter 1: By soft-key 0: By touch sensor		0	1	
	2	Mode of measuring by work/offset presetter 0: By I/O 1: By soft-key		0	1	
5013	0	Tool measuring direction by offset presetter 0: X direction 1: Y direction		0	1	
	2	Validity of when both offset presetter/TLM are on 0: TLM is valid 1: Offset presetter is valid		0	1	
	3	Execution of TLM measurement in manual skip B 0: Not executed 1: Executed		0	1	
	4	TLM home position return when ROV=0% 0: Abort 1: Continue		0	1	
6008	0	Measuring objective by tool length measurement 0: Travel distance 1: Remaining distance		0	1	
6840		Offset presetter measuring direction	0.001mm	-999999999	999999999	
6841		Offset presetter measuring direction reference value, Z0	0.001mm	-999999999	999999999	
6842		Work presetter measuring probe radius, (DX+)	0.001mm	-999999999	999999999	
6843		Work presetter measuring probe radius, (DX-)	0.001mm	-999999999	999999999	
6844		Work presetter measuring probe radius, (DY+)	0.001mm	-999999999	999999999	
6845		Work presetter measuring probe radius, (DY-)	0.001mm	-999999999	999999999	
6846		Work presetter measuring probe radius, (HZ-)	0.001mm	-999999999	999999999	

Address	Bit	Description	Register Units	Minimum Value	Maximum Value	Long Description
6847		Work presetter measuring enabled retraction stroke	0.001mm	-999999999	999999999	
6848		Work presetter measuring point feed-away stroke	0.001mm	-999999999	999999999	

Motion

Address	Bit	Description	Register Units	Minimum Value	Maximum Value	Long Description
860		Deceleration feedrate by corner feedrate "mm"	mm/min	0	240000	Deceleration feedrate by corner feedrate designation function, "mm" mode (P)
861		Deceleration distance by corner feedrate "mm"	0.001mm	0	999999999	Deceleration distance by corner feedrate designation function, "mm" mode (L)
862		Deceleration feedrate by corner feedrate "inch"	0.1inch/min	0	94488	Deceleration feedrate by corner feedrate designation function, "inch" mode (P)
863		Deceleration distance by corner feedrate "inch"	0.0001inch	0	393700787	Deceleration distance by corner feedrate designation function, "inch" mode (L)
1000	7	SAGR check when rapid to feed 0: Not checked 1: Checked		0	1	Checking of SAGR when feed rate is changed from rapid to feed
4015	3	In-position check at the completion of G04 1: Checked 0: Not checked		0	0	
	4	In-position check when G code is changed to G00 0: Not checked 1: Checked		0	1	
4461		1st axis overtravel distance in G60	0.001mm	0	32767	
4462		2nd axis overtravel distance in G60	0.001mm	0	32767	
4463		3rd axis overtravel distance in G60	0.001mm	0	32767	
4464		4th axis overtravel distance in G60	0.001mm	0	32767	
4465		5th axis overtravel distance in G60	0.001mm	0	32767	
4820		Allowable error range when arc radius is specified	0.001mm	0	999999999	

NC System

Address	Bit	Description	Register Units	Minimum Value	Maximum Value	Long Description
0	0	Single-block switch		0	1	
	1	Machine lock switch		0	1	
	2	Dry run switch		0	1	
	3	Block delete switch		0	1	
	4	Manual absolute switch		0	1	
	5	Auxiliary function lock switch		0	1	
	6	Display lock switch		0	1	
	7	Edit Lock switch		0	1	
1	0	Optional stop switch		0	1	
	1	Start lock switch		0	1	
	2	Z-axis neglect switch		0	1	
2	0	Mirror image 1		0	1	
	1	Mirror image 2		0	1	
	2	Mirror image 3		0	1	
	3	Mirror image 4		0	1	
	4	Mirror image 5		0	1	
3	1	Axis disconnection designation (4th-axis)		0	1	
	2	Axis disconnection designation (5th-axis)		0	1	
5	0	Manual zero return switch		0	1	
	1	No. 2 manual zero return switch		0	1	
	2	Interruption point return switch		0	1	
	3	Automatic mode handle offset switch		0	1	
	4	Setup point return switch		0	1	
	5	Playback switch		0	1	
	6	F1-digit switch		0	1	
	7	Program restart switch		0	1	
7	6	“0” data in parameter output		0	1	
48	0	Servo current adjustment		0	1	Servo U-phase V-phase current command offset adjustment
107		Manual skip measuring point monitor		0	6	
109		Internal system number switch setting		0	1	

Address	Bit	Description	Register Units	Minimum Value	Maximum Value	Long Description
811		1st axis skip position	0.001mm	-999999999	999999999	Coordinate values when skip signal is operating (1st axis)
812		2nd axis skip position	0.001mm	-999999999	999999999	Coordinate values when skip signal is operating (2nd axis)
813		3rd axis skip position	0.001mm	-999999999	999999999	Coordinate values when skip signal is operating (3rd axis)
814		4th axis skip position	0.001mm	-999999999	999999999	Coordinate values when skip signal is operating (4th axis)
815		5th axis skip position	0.001mm	-999999999	999999999	Coordinate values when skip signal is operating (5th axis)
4001	7	Cycle start interlock when system number		0	1	System number switch "1" or pm0109 = 1
5012	0	Servo power ON method		0	1	
	3	SVMX OFF function		0	1	
5400		Time from base block cancel to brake release	msec	0	32767	
5401		Time from ESP signal rising to base block on 1st axis	msec	0	32767	multiply of 10msec
5402		Time from ESP signal rising to base block on 2nd axis	msec	0	32767	multiply of 10msec
5403		Time from ESP signal rising to base block on 3rd axis	msec	0	32767	multiply of 10msec
5404		Time from ESP signal rising to base block on 4th axis	msec	0	32767	multiply of 10msec
5405		Time from ESP signal rising to base block on 5th axis	msec	0	32767	multiply of 10msec
5410		Time from sending M,S,T code to sending of	msec	0	32767	
5413		Parts counter keep memory address		0	7999	Parts counter use 2 bytes keep memory area
5420		Software switch, input keep memory start number		7000	7999	
5421		Software switch, output keep memory start number		7000	7999	
5426		Spindle tool number stored keep memory number		7000	7999	
5427		Program restart switch, keep memory number		7000	7999	

Address	Bit	Description	Register Units	Minimum Value	Maximum Value	Long Description
5428		Manual skip signal, keep memory number (work		7000	7999	
6130		No.1 position monitor, check axis number		0	5	
6131		No.2 position monitor, check axis number		0	5	
6132		No.3 position monitor, check axis number		0	5	
6133		No.4 position monitor, check axis number		0	1	
6134		No.5 position monitor, check axis number		0	5	
6135		No.6 position monitor, check axis number		0	5	
6136		No.7 position monitor, check axis number		0	5	
6137		No.8 position monitor, check axis number		0	5	
6920		No.1 position monitor forward dir area boundary value	0.001mm	-999999999	999999999	
6921		No.2 position monitor forward dir area boundary value	0.001mm	-999999999	999999999	
6922		No.3 position monitor forward dir area boundary value	0.001mm	-999999999	999999999	
6923		No.4 position monitor forward dir area	0.001mm	-999999999	999999999	
6924		No.5 position monitor forward dir area boundary value	0.001mm	-999999999	999999999	
6925		No.6 position monitor forward dir area boundary value	0.001mm	-999999999	999999999	
6926		No.7 position monitor forward dir area boundary value	0.001mm	-999999999	999999999	
6927		No.8 position monitor forward dir area boundary value	0.001mm	-999999999	999999999	
6930		No.1 position monitor reverse dir area boundary value	0.001mm	-999999999	999999999	
6931		No.2 position monitor reverse dir area boundary value	0.001mm	-999999999	999999999	
6932		No.3 position monitor reverse dir area boundary value	0.001mm	-999999999	999999999	
6933		No.4 position monitor reverse dir area boundary value	0.001mm	-999999999	999999999	
6934		No.5 position monitor reverse dir area boundary value	0.001mm	-999999999	999999999	

Address	Bit	Description	Register Units	Minimum Value	Maximum Value	Long Description
6935		No.6 position monitor reverse dir area boundary value	0.001mm	-999999999	999999999	
6936		No.7 position monitor reverse dir area boundary value	0.001mm	-999999999	999999999	
6937		No.8 position monitor reverse dir area boundary value	0.001mm	-999999999	999999999	

Operation

Address	Bit	Description	Register Units	Minimum Value	Maximum Value	Long Description
7	1	Single block in Macro 1: Interrupted by single block stop 0: Not interrupted by single block stop		0	1	Operation instructions and control instructions in user macro.
20	0	Macro edit/display lock for O8000 1: Prohibited 0: Permitted		0	1	Edit, display, and input/output operation of part programs O8000 to O8999

Address	Bit	Description	Register Units	Minimum Value	Maximum Value	Long Description
21	0	Macro edit lock for O8000 1: Prohibited 0: Permitted		0	1	Edit, input/ output opera- tion of part pro- grams O8000 to O8999
22	0	Macro edit lock for O9000 1: Prohibited 0: Permitted		0	1	Edit, input/ output opera- tion of part pro- grams O9000 to O9999

Address	Bit	Description	Register Units	Minimum Value	Maximum Value	Long Description
3002	0	Clearing MDI buffer at completion of MDI 1: Not cleared 0: Cleared		0	1	Clearing MDI buffer by program reset if M02 or M30 is specified at the completion of MDI program
	1	Clearing MDI buffer by reset operation 1: Not cleared 0: Cleared		0	1	
	2	Start position of MDI program 1: Beginning of the MDI program 0: Present cursor position		0	1	

Address	Bit	Description	Register Units	Minimum Value	Maximum Value	Long Description
3004	0	Edit/display/output of O9000 to O9999 program 1: Prohibited 0: Permitted		0	1	
	6	Work pos, Work shift, Tool off change in EDT LOCK 1: Prohibited 0: Permitted		0	1	
3005	1	Clearing of the program numbers at power ON 1: Not cleared 0: Cleared		0	1	
	4	Auto edit of program number when 0: Not Edited 1: Edited automatically		0	1	
3007	2	Program upload operation during EDIT LOCK 0: Prohibited 1: Permitted		0	1	
	3	Program download operation during EDIT LOCK 0: Prohibited 1: Permitted		0	1	

Address	Bit	Description	Register Units	Minimum Value	Maximum Value	Long Description
4008	0	Rewind execution pointer when external reset 1: Not rewind 0: Rewind		0	1	
	3	Starting memory operation from a block midpoint 1: Prohibited 0: Permitted		0	1	
	7	High-speed automatic start for high-speed rewind 0: Invalid 1: Valid		0	1	

Address	Bit	Description	Register Units	Minimum Value	Maximum Value	Long Description
4009	0	Macro system value #5001 at execute G31 skip 1: Command value 0: Present value		0	1	
	1	Macro variables #100 - #299 become empty by reset 0: Cleared 1: Not cleared		0	1	
	2	Output leading zeros at DPRINT 0: Spaces are output 1: Nothing is output		0	1	
	3	Macro system value #1100-#1132 when reset 1: Not cleared 0: Cleared		0	1	

Address	Bit	Description	Register Units	Minimum Value	Maximum Value	Long Description
4024	0	1st axis validity of playback write 0: Invalid 1: Valid		0	1	
	1	2ndt axis validity of playback write 0: Invalid 1: Valid		0	1	
	2	3rd axis validity of playback write 0: Invalid 1: Valid		0	1	
	3	4th axis validity of playback write 0: Invalid 1: Valid		0	1	
	4	5th axis validity of playback write 0: Invalid 1: Valid		0	1	
4025	5	Validity of playback F command write 0: Invalid 1: Valid		0	1	
	6	Validity of playback S command write 0: Invalid 1: Valid		0	1	
	7	Validity of playback T command write 0: Invalid 1: Valid		0	1	

Address	Bit	Description	Register Units	Minimum Value	Maximum Value	Long Description
4160		High speed mode conversion type 0: No conversion 1: Specific area conversion		0	2	

Pitch Error

Address	Bit	Description	Register Units	Minimum Value	Maximum Value	Long Description
6000	0	Pitch error compensation 1st axis 0: Invalid 1: Valid		0	1	
	1	Pitch error compensation 2nd axis 0: Invalid 1: Valid		0	1	
	2	Pitch error compensation 3rd axis 0: Invalid 1: Valid		0	1	
	3	Pitch error compensation 4th axis 0: Invalid 1: Valid		0	1	
	4	Pitch error compensation 5th axis 0: Invalid 1: Valid		0	1	
6001	0	Setting of compensation data for pitch error comp 0: Incremental 1: Absolute		0	1	

Address	Bit	Description	Register Units	Minimum Value	Maximum Value	Long Description
6002	2	No.1 stored stroke limit check 3rd axis execution 0: Executed 1: Not executed		0	1	
	3	No.1 stored stroke limit check 4th axis execution 0: Executed 1: Not executed		0	1	
	4	No.1 stored stroke limit check 5th axis execution 0: Executed 1: Not executed		0	1	
6101		1st axis, pitch error compensation multiplication		0	3	
6102		2nd axis, pitch error compensation multiplication		0	3	
6103		3rd axis, pitch error compensation multiplication		0	3	
6104		4th axis, pitch error compensation multiplication		0	3	
6105		5th axis, pitch error compensation multiplication		0	3	
6401		1st axis, pitch error start memory number		0	1151	
6402		2nd axis, pitch error start memory number		0	1151	
6403		3rd axis, pitch error start memory number		0	1151	
6404		4th axis, pitch error start memory number		0	1151	
6405		5th axis, pitch error start memory number		0	1151	
6411		1st axis, pitch error completion memory number		0	1151	
6412		2nd axis, pitch error completion memory number		0	1151	
6413		3rd axis, pitch error completion memory number		0	1151	
6414		4th axis, pitch error completion memory number		0	1151	
6415		5th axis, pitch error completion memory number		0	1151	
6421		1st axis, pitch error reference point memory number		0	1151	

Rapid

Address	Bit	Description	Register Units	Minimum Value	Maximum Value	Long Description
20000	0	Dry run during fast feed 1: Valid 0: Invalid		0	1	
	6	Replacing RAPID reverse with JOG until Zero return 0: RAPID is not replaced with JOG 1: RAPID is replaced with JOG		0	1	
20005	0	G00 interpolation mode 1: Valid 0: Invalid		0	1	
20045		Rapid feed bias value	%	0	100	
20061		1st axis rapid feed accel/decel time constant	ms	0	32767	Set multiple of 4
20062		2nd axis rapid feed accel/decel time constant	ms	0	32767	Set multiple of 4
20063		3rd axis rapid feed accel/decel time constant	ms	0	32767	Set multiple of 4

Address	Bit	Description	Register Units	Minimum Value	Maximum Value	Long Description
2 4 6 4		4th axis rapid feed accel/decel time constant	m s e c	0	3 2 7 6 7	Set multi- ple of 4
2 4 6 5		5th axis rapid feed accel/decel time constant	m s e c	4	3 2 7 6 7	Set multi- ple of 4
2 5 7 1		1st axis accel/ decel time const- nat in No2 G00	m s e c	0	3 2 7 6 7	Set multi- ple of 4
2 5 7 2		2nd axis accel/ decel time const- nat in No2 G00 mode	m s e c	0	3 2 7 6 7	Set multi- ple of 4
2 5 7 3		3rd axis accel/ decel time con- stant in No2 G00 mode	m s e c	0	3 2 7 6 7	Set multi- ple of 4
2 5 7 4		4th axis accel/ decel time con- stant in No2 G00 mode	m s e c	0	3 2 7 6 7	Set multi- ple of 4
2 5 7 5		5th axis accel/ decel time con- stant in No2 G00 mode	m s e c	0	3 2 7 6 7	Set multi- ple of 4

Address	Bit	Description	Register Units	Minimum Value	Maximum Value	Long Description
2	5	1st axis rapid feed accel/decel		0	2	
9	1	S-curve			0	
2	5	2nd axis rapid feed accel/decel		0	2	
9	2	S-curve			0	
2	5	3rd axis rapid feed accel/decel		0	2	
9	3	S-curve			0	
2	5	4th axis rapid feed accel/decel		0	2	
9	4	S-curve			0	
2	5	5th axis rapid feed accel/decel		0	2	
9	5	S-curve			0	
2	6	1st axis rapid feed accel/decel		0	1	
0	1	S-curve in 2nd S			5	
2	6	2nd axis rapid feed accel/decel		0	1	
0	2	S-curve in 2nd S			5	
2	6	3rd axis rapid feed accel/decel		0	1	
0	3	S-curve in 2nd S			5	
2	6	4th axis rapid feed accel/decel		0	1	
0	4	S-curve in 2nd S			5	

Address	Bit	Description	Register Units	Minimum Value	Maximum Value	Long Description
2055	2 6 0 5	5th axis rapid feed accel/decel S-curve in 2nd S		0	1 5	
2801	2 8 0 1	1st axis Rapid feed rate	m m / m i n	0	2 4 0 0 0 0	
2802	2 8 0 2	2nd axis Rapid feed rate	m m / m i n	0	2 4 0 0 0 0	
2803	2 8 0 3	3rd axis Rapid feed rate	m m / m i n	0	2 4 0 0 0 0	
2804	2 8 0 4	4th axis Rapid feed rate	m m / m i n	0	2 4 0 0 0 0	
2805	2 8 0 5	5th axis Rapid feed rate	m m / m i n	0	2 4 0 0 0 0	

Address	Bit	Description	Register Units	Minimum Value	Maximum Value	Long Description
2		1st axis rapid	m	0	2	
8		feed rate in 2nd	m		4	
1		S-curve accel/	/		0	
1		decel	m		0	
			i		0	
			n		0	
			,			
			d			
			e			
			g			
			/			
			m			
			i			
			n			
2		2nd axis rapid	m	0	2	
8		feed rate in 2nd	m		4	
1		S-curve accel/	/		0	
2		decel	m		0	
			i		0	
			n		0	
			,			
			d			
			e			
			g			
			/			
			m			
			i			
			n			

Address	Bit	Description	Register Units	Minimum Value	Maximum Value	Long Description
2		3rd axis rapid	m	0	2	
8		feed rate in 2nd	m		4	
1		S-curve accel/	/		0	
3		dece	m		0	
			i		0	
			n		0	
			,			
			d			
			e			
			g			
			/			
			m			
			i			
			n			
2		4th axis rapid	m	0	2	
8		feed rate in 2nd	m		4	
1		S-curve accel/	/		0	
4		decel	m		0	
			i		0	
			n		0	
			,			
			d			
			e			
			g			
			/			
			m			
			i			
			n			

Address	Bit	Description	Register Units	Minimum Value	Maximum Value	Long Description
2		5th axis rapid	m	0	2	
8		feed rate in 2nd	m		4	
1		S-curve accel/	/		0	
5		decel	m		0	
			i		0	
			n		0	
			,			
			d			
			e			
			g			
			/			
			m			
			i			
			n			
2		1st axis second	m	0	2	
8		G00 feedrate	m		4	
5			/		0	
1			m		0	
			i		0	
			n		0	
			,			
			d			
			e			
			g			
			/			
			m			
			i			
			n			

Address	Bit	Description	Register Units	Minimum Value	Maximum Value	Long Description
2852		2nd axis second G00 feedrate	mm/min	0	24000	
2853		3rd axis second G00 feedrate	mm/min	0	24000	

Address	Bit	Description	Register Units	Minimum Value	Maximum Value	Long Description
2		4th axis second	m	0	2	
8		G00 feedrate	m		4	
5			/		0	
4			m		0	
			i		0	
			n		0	
			,			
			d			
			e			
			g			
			/			
			m			
			i			
			n			
2		5th axis second	m	0	2	
8		G00 feedrate	m		4	
5			/		0	
5			m		0	
			i		0	
			n		0	
			,			
			d			
			e			
			g			
			/			
			m			
			i			
			n			

Reduced Vibration When Stop

Address	Bit	Description	Register Units	Minimum Value	Maximum Value	Long Description
1097	0	1st axis Reduced vibration when servo stop		0	1	
	1	2nd axis Reduced vibration when servo stop		0	1	
	2	3rd axis Reduced vibration when servo stop		0	1	
	3	4th axis Reduced vibration when servo stop		0	1	
	4	5th axis Reduced vibration when servo stop		0	1	
1371		1st axis Reduced vibration level when servo stop	%	0	100	
1372		2nd axis Reduced vibration level when servo stop	%	0	100	
1373		3rd axis Reduced vibration level when servo stop	%	0	100	
1374		4th axis Reduced vibration level when servo stop	%	0	100	
1375		5th axis Reduced vibration level when servo stop	%	0	100	

Reference Point Return

Address	Bit	Description	Register Units	Minimum Value	Maximum Value	Long Description
1044	5	1st axis Zero return Virtual C phase motor 1 rev. 1: Use pm1851 0: Use pm1821		0	1	
1045	5	2nd axis Zero return Virtual C phase motor 1 rev. 1: Use pm1851 0: Use pm1821		0	1	
1046	5	3rd axis Zero return Virtual C phase motor 1 1: Use pm1851 0: Use pm1821		0	1	
1047	5	4th axis Zero return Virtual C phase motor 1 rev. 1: Use pm1851 0: Use pm1821		0	1	
1048	5	5th axis Zero return Virtual C phase motor 1 rev. 1: Use pm1851 0: Use pm1821		0	1	
2521		1st axis reference point return approach speed	mm/min, deg/min	0	32767	
2522		2nd axis reference point return approach speed	mm/min, deg/min	0	32767	
2523		3rd axis reference point return approach speed	mm/min, deg/min	0	32767	
2524		4th axis reference point return approach speed	mm/min, deg/min	0	32767	
2525		5th axis reference point return approach speed	mm/min, deg/min	0	32767	
2531		1st axis reference point return creep speed	mm/min, deg/min	0	32767	
2532		2nd axis reference point return creep speed	mm/min, deg/min	0	32767	
2533		3rd axis reference point return creep speed	mm/min, deg/min	0	32767	
2534		4th axis reference point return creep speed	mm/min, deg/min	0	32767	
2535		5th axis reference point return creep speed	mm/min, deg/min	0	32767	
4001	6	Occurrence of Alarm cycle start before Zero return 0: An alarm occurs 1: An alarm does not occur		0	1	Conforms to pm4018 d0-d4

Address	Bit	Description	Register Units	Minimum Value	Maximum Value	Long Description
4002	0	1st axis Reference point return direction 1: Negative direction 0: Positive direction		0	1	
	1	2nd axis Reference point return direction 1: Negative direction 0: Positive direction		0	1	
	2	3rd axis Reference point return direction 1: Negative direction 0: Positive direction		0	1	
	3	4th axis Reference point return direction 1: Negative direction 0: Positive direction		0	1	
	4	5th axis Reference point return direction 1: Negative direction 0: Positive direction		0	1	
4003	6	Manual Zero return type in 2nd and later 0: High-speed type 1: Low-speed type		0	1	
	7	Auto mode Zero return type in 2nd and later 0: High-speed type 1: Low-speed type		0	1	

Address	Bit	Description	Register Units	Minimum Value	Maximum Value	Long Description
4004	0	Alarm occur if axis move command before ZRN 1st axis 1: Alarm occurs 0: Alarm does not occur		0	1	Occurrence of alarm if movement command other than G28 is executed without carrying out manual or automatic reference point return for 1st axis
	1	Alarm occur if axis move command before ZRN 2nd axis 1: Alarm occurs 0: Alarm does not occur				Occurrence of alarm if movement command other than G28 is executed without carrying out manual or automatic reference point return for 2nd axis
	2	Alarm occur if axis move command before ZRN 3rd axis 1: Alarm occurs 0: Alarm does not occur		0	1	Occurrence of alarm if movement command other than G28 is executed without carrying out manual or automatic reference point return for 3rd axis
	3	Alarm occur if axis move command before ZRN 4th axis 1: Alarm occurs 0: Alarm does not occur				Occurrence of alarm if movement command other than G28 is executed without carrying out manual or automatic reference point return for 4th axis
	4	Alarm occur if axis move command before ZRN 5th axis 1: Alarm occurs 0: Alarm does not occur		0	1	Occurrence of alarm if movement command other than G28 is executed without carrying out manual or automatic reference point return for 5th axis

Address	Bit	Description	Register Units	Minimum Value	Maximum Value	Long Description
4018	0	1st axis alarm occur when cycle start without ZRN 1: Alarm occurs 0: Alarm does not occur		0	1	
	1	2nd axis alarm occur when cycle start without ZRN 1: Alarm occurs 0: Alarm does not occur		0	1	
	2	3rd axis alarm occur when cycle start without ZRN 1: Alarm occurs 0: Alarm does not occur		0	1	
	3	4th axis alarm occur when cycle start without ZRN 1: Alarm occurs 0: Alarm does not occur		0	1	
	4	5th axis alarm occur when cycle start without ZRN 1: Alarm occurs 0: Alarm does not occur		0	1	
4022	0	1st axis validity of reference point return 1: Valid 0: Invalid		0	1	
	1	2nd axis validity of reference point return 1: Valid 0: Invalid		0	1	
	2	3rd axis validity of reference point return 1: Valid 0: Invalid		0	1	
	3	4th axis validity of reference point return 1: Valid 0: Invalid		0	1	
	4	5th axis validity of reference point return 1: Valid 0: Invalid		0	1	
4451		1st axis reference point return traverse distance	0.001mm	0	32767	
4452		2nd axis reference point return traverse distance	0.001mm	0	32767	
4453		3rd axis reference point return traverse distance	0.001mm	0	32767	
4454		4th axis reference point return traverse distance	0.001mm	0	32767	
4455		5th axis reference point return traverse distance	0.001mm	0	32767	

Address	Bit	Description	Register Units	Minimum Value	Maximum Value	Long Description
6811		1st axis, second reference point position	0.001mm	-999999999	999999999	
6812		2nd axis, second reference point position	0.001mm	-999999999	999999999	
6813		3rd axis, second reference point position	0.001mm	-999999999	999999999	
6814		4th axis, second reference point position	0.001mm	-999999999	999999999	
6815		5th axis, second reference point position	0.001mm	-999999999	999999999	
6821		1st axis, third reference point position	0.001mm	-999999999	999999999	
6822		2nd axis, third reference point position	0.001mm	-999999999	999999999	
6823		3rd axis, third reference point position	0.001mm	-999999999	999999999	
6824		4th axis, third reference point position	0.001mm	-999999999	999999999	
6825		5th axis, third reference point position	0.001mm	-999999999	999999999	
6831		1st axis, fourth reference point position	0.001mm	-999999999	999999999	
6832		2nd axis, fourth reference point position	0.001mm	-999999999	999999999	
6833		3rd axis, fourth reference point position	0.001mm	-999999999	999999999	
6834		4th axis, fourth reference point position	0.001mm	-999999999	999999999	
6835		5th axis, fourth reference point position	0.001mm	-999999999	999999999	

Roundness Irregularity

Address	Bit	Description	Register Units	Minimum Value	Maximum Value	Long Description
1080	0	1st axis roundness irregularity compensation 0: Not available 1: Available		0	1	
	1	2nd axis roundness irregularity compensation 0: Not available 1: Available		0	1	
	2	3rd axis roundness irregularity compensation 0: Not available 1: Available		0	1	
	3	4th axis roundness irregularity compensation 0: Not available 1: Available		0	1	
	4	5th axis roundness irregularity compensation 0: Not available 1: Available		0	1	
8471		1st axis (- to +) roundness irregularity Integral constant	msec	0	32767	
8472		2nd axis (- to +) roundness irregularity Integral constant	msec	0	32767	
8473		3rd axis (- to +) roundness irregularity Integral constant	msec	0	32767	
8474		4th axis (- to +) roundness irregularity Integral constant	msec	0	32767	
8475		5th axis (- to +) roundness irregularity Integral constant	msec	0	32767	
8481		1st axis (- to +) roundness irregularity completion torque	0.0001	0	20000	
8482		2nd axis (- to +) roundness irregularity completion torque	0.0001	0	20000	
8483		3rd axis (- to +) roundness irregularity completion torque	0.0001	0	20000	
8484		4th axis (- to +) roundness irregularity completion torque	0.0001	0	20000	
8485		5th axis (- to +) roundness irregularity completion torque	0.0001	0	20000	
8491		1st axis roundness irregularity Timing parameter	0.01[1/S]	-32767	32767	
8492		2nd axis roundness irregularity Timing parameter	0.01[1/S]	-32767	32767	
8493		3rd axis roundness irregularity Timing parameter	0.01[1/S]	-32767	32767	
8494		4th axis roundness irregularity Timing parameter	0.01[1/S]	-32767	32767	

Address	Bit	Description	Register Units	Minimum Value	Maximum Value	Long Description
8495		5th axis roundness irregularity Timing parameter	0.01[1/S]	-32767	32767	
8521		1st axis roundness irregularity weight compensation torque	0.0001	-12000	12000	
8522		2nd axis roundness irregularity weight compensation torque	0.0001	-12000	12000	
8523		3rd axis roundness irregularity weight compensation torque	0.0001	-12000	12000	
8524		4th axis roundness irregularity weight compensation torque	0.0001	-12000	12000	
8525		5th axis roundness irregularity weight compensation torque	0.0001	-12000	12000	

Screen

Address	Bit	Description	Register Units	Minimum Value	Maximum Value	Long Description
3002	0	Clearing MDI buffer at completion of MDI program		0	1	Clearing MDI buffer by program reset if M02 or M30 is specified at the completion of MDI program
	1	Clearing MDI buffer by reset operation		0	1	
	2	Start position of MDI program		0	1	
3004	6	Work pos, Work shift, Tool off change in EDT LOCK		0	1	
3005	1	Clearing of the program numbers at power ON		0	1	
	4	Auto edit of program number when		0	1	
3007	2	Program upload operation during EDIT LOCK		0	1	
	3	Program download operation during EDIT LOCK		0	1	
4008	0	Rewind execution pointer when external reset		0	1	
	3	Starting memory operation from a block midpoint		0	1	
	7	High-speed automatic start for high-speed rewind		0	1	
4024	0	1st axis validity of playback write		0	1	
	1	2nd axis validity of playback write		0	1	
	2	3rd axis validity of playback write		0	1	
	3	4th axis validity of playback write		0	1	
4024	4	5th axis validity of playback write		0	1	
4025	5	Validity of playback F command write		0	1	
	6	Validity of playback S command write		0	1	
	7	Validity of playback T command write		0	1	

Servo

Address	Bit	Description	Register Units	Minimum Value	Maximum Value	Long Description
1020	0	1st axis YENET station number 0: non 1: No1 station 2: No2 station 3: No3 station 4: No4 station 5: No5 station 6: No6 station 7: No7 station 8: No8 station 9: No9 station 10: No10 station 11: No11 station 12: No12 station 13: No13 station 14: No14 station 15: No15 station		0	15	1st Physical servo axis YENET1200 station number setting (No. 2 to No. 15 station)
	5	1st axis debug mode 1: Valid 0: Invalid		0	1	
	6	1st axis Physical servo axis specifications 0: Servo axis 1: C-axis integral with spindle		0	1	
	7	1st axis Physical servo axis enable 1: Valid 0: Invalid		0	1	
1021	0	2nd axis YENET station number 0: non 1: No1 station 2: No2 station 3: No3 station 4: No4 station 5: No5 station 6: No6 station 7: No7 station 8: No8 station 9: No9 station 10: No10 station 11: No11 station 12: No12 station 13: No13 station 14: No14 station 15: No15 station		0	15	2nd Physical servo axis YENET1200 station) number setting (No. 2 to No. 15 station)
	5	2nd axis debug mode 1: Valid 0: Invalid		0	1	
	6	2nd axis Physical servo axis specifications 0: Servo axis 1: C-axis integral with spindle		0	1	
	7	2nd axis Physical servo axis enable 0: Invalid 1: Valid		0	1	

Address	Bit	Description	Register Units	Minimum Value	Maximum Value	Long Description
1022	0	3rd axis YENET station number 1: No1 station 2: No2 station 3: No3 station 4: No4 station 5: No5 station 6: No6 station 7: No7 station 8: No8 station 9: No9 station 10: No10 station 11: No11 station 12: No12 station 13: No13 station 14: No14 station 15: No15 station		0	15	3rd Physical servo axis YENET1200 station number setting (No. 2 to No. 15 station)
	5	3rd axis debug mode 1: Valid 0: Invalid		0	1	
	6	3rd axis Physical servo axis specifications 0: Servo axis 1: C-axis integral with spindle		0	1	
	7	3rd axis Physical servo axis enable 0: Invalid 1: Valid		0	1	
1023	0	4th axis YENET station number 1: No1 station 2: No2 station 3: No3 station 4: No4 station 5: No5 station 6: No6 station 7: No7 station 8: No8 station 9: No9 station 10: No10 station 11: No11 station 12: No12 station 13: No13 station 14: No14 station 15: No15 station		0	15	4th Physical servo axis YENET1200 station number setting (No. 2 to No. 15 station)
	5	4th axis debug mode 1: Valid 0: Invalid		0	1	
	6	4th axis Physical servo axis specifications 0: Servo axis 1: C-axis integral with spindle		0	1	
	7	4th axis Physical servo axis enable 0: Invalid 1: Valid		0	1	

Address	Bit	Description	Register Units	Minimum Value	Maximum Value	Long Description
1024	0	5th axis YENET station number 1: No1 station 2: No2 station 3: No3 station 4: No4 station 5: No5 station 6: No6 station 7: No7 station 8: No8 station 9: No9 station 10: No10 station 11: No11 station 12: No12 station 13: No13 station 14: No14 station 15: No15 station		0	15	5th Physical servo axis YENET1200 station number setting (No. 2 to No. 15 station)
	5	5th axis debug mode 1: Valid 0: Invalid		0	1	
	6	5th axis Physical servo axis specifications 0: Servo axis 1: C-axis integral with spindle		0	1	
	7	5th axis Physical servo axis enable 0: Invalid 1: Valid		0	1	
1030	0	1st axis Velocity loop control method 0: PI control 1: IP control		0	1	
	1	1st axis Velocity loop control automatic setting 0: Invalid 1: Valid		0	1	
	6	1st axis Axis type 0: Linear axis 1: Rotary axis		0	1	
	7	1st axis Servo Motor rotation direction 0: Forward rotation 1: Reverse rotation		0	1	

Address	Bit	Description	Register Units	Minimum Value	Maximum Value	Long Description
1031	0	2nd axis Velocity loop control method 0: PI control 1: IP control		0	1	
	1	2nd axis Velocity loop control automatic setting 1: Valid 0: Invalid		0	1	
	6	2nd axis Axis type 1: Rotary axis 2: Linear axis		0	1	
	7	2nd axis Servo Motor rotation direction 1: Reverse rotation 0: Forward rotation		0	1	
1032	0	3rd axis Velocity loop control method 0: PI control 1: IP control		0	1	
	1	3rd axis Velocity loop control automatic setting 1: Valid 0: Invalid		0	1	
	6	3rd axis Axis type 0: Linear axis 1: Rotary axis		0	1	
	7	3rd axis Servo Motor rotation direction 1: Reverse rotation 0: Forward rotation		0	1	
1033	0	4th axis Velocity loop control method 0: PI control 1: IP control		0	1	
	1	4th axis Velocity loop control automatic setting 1: Valid 0: Invalid		0	1	
	6	4th axis Axis type 0: Linear axis 1: Rotary axis		0	1	
	7	4th axis Servo Motor rotation direction 1: Reverse rotation 0: Forward rotation		0	1	

Address	Bit	Description	Register Units	Minimum Value	Maximum Value	Long Description
1034	0	5th axis Velocity loop control method 0: PI control 1: IP control		0	1	
	1	5th axis Velocity loop control automatic setting 1: Valid 0: Invalid		0	1	
	6	5th axis Axis type 0: Linear axis 1: Rotary axis		0	1	
	7	5th axis Servo Motor rotation direction 1: Reverse rotation 0: Forward rotation		0	1	
1044	0	1st axis Servo feed amount change 1: Executed 0: Not executed		0	1	
	2	1st axis Disregarding error pulse at emergency stop 1: Disregarded 0: Not disregarded		0	1	
	3	1st axis Follow-up processing for servo OFF 1: Executed 0: Not executed		0	1	
	6	1st axis Infinite length for rotary axis control 1: Possible 0: Not possible		0	1	
	7	1st axis Use of 17-bit encoder 0: Not used 1: Used		0	1	
1045	0	2nd axis Servo feed amount change 1: Executed 0: Not executed		0	1	
	2	2nd axis Disregarding error pulse at emergency stop 1: Disregarded 0: Not disregarded		0	1	
	3	2nd axis Follow-up processing for servo OFF 1: Executed 0: Not executed		0	1	
	6	2nd axis Infinite length for rotary axis control 1: Possible 0: Not possible		0	1	
	7	2nd axis Use of 17-bit encoder 0: Not used 1: Used		0	1	

Address	Bit	Description	Register Units	Minimum Value	Maximum Value	Long Description
1046	0	3rd axis Servo feed amount change 1: Executed 0: Not executed		0	1	
	2	3rd axis Disregarding error pulse at emergency 1: Disregarded 0: Not disregarded		0	1	
	3	3rd axis Follow-up processing for servo OFF 1: Executed 0: Not executed		0	1	
	6	3rd axis Infinite length for rotary axis control 1: Possible 0: Not possible		0	1	
	7	3rd axis Use of 17-bit encoder 0: Not used 1: Used		0	1	
1047	0	4th axis Servo feed amount change 1: Executed 0: Not executed		0	1	
	2	4th axis Disregarding error pulse at emergency stop 1: Disregarded 0: Not disregarded		0	1	
	3	4th axis Follow-up processing for servo OFF 1: Executed 0: Not executed		0	1	
	6	4th axis Infinite length for rotary axis control 1: Possible 0: Not possible		0	1	
	7	4th axis Use of 17-bit encoder 0: Not used 1: Used		0	1	

Address	Bit	Description	Register Units	Minimum Value	Maximum Value	Long Description
1048	0	5th axis Servo feed amount change 1: Executed 0: Not executed		0	1	
	2	5th axis Disregarding error pulse at emergency stop 1: Disregarded 0: Not disregarded		0	1	
	3	5th axis Follow-up processing for servo OFF 1: Executed 0: Not executed		0	1	
	6	5th axis Infinite length for rotary axis control 1: Possible 0: Not possible		0	1	
	7	5th axis Use of 17-bit encoder 0: Not used 1: Used		0	1	
1061	0	Setting of motor selection code for 1st axis 177: SGMG-44A_A 176: SGMG-30A_A 175: SGMG-20A_A 174: SGMG-12A_A 173: SGMG-09A_A 172: SGMG-06A_A 171: SGMG-03A_A 147: SGMG-44A/C 146: SGMG-30A/C 145: SGMG-20A/C 144: SGMG-13A/C 143: SGMG-09A/C 142: SGMG-05A/C 0: Non		0	255	
1062	0	Setting of motor selection code for 2nd axis 177: SGMG-44A_A 176: SGMG-30A_A 175: SGMG-20A_A 174: SGMG-12A_A 173: SGMG-09A_A 172: SGMG-06A_A 171: SGMG-03A_A 147: SGMG-44A/C 146: SGMG-30A/C 145: SGMG-20A/C 144: SGMG-13A/C 143: SGMG-09A/C 142: SGMG-05A/C 0: Non		0	255	

Address	Bit	Description	Register Units	Minimum Value	Maximum Value	Long Description
1063	0	Setting of motor selection code for 3rd axis 177: SGMG-44A_A 142: SGMG-05A/C 176: SGMG-30A_A 0: Non 175: SGMG-20A_A 174: SGMG-12A_A 173: SGMG-09A_A 172: SGMG-06A_A 171: SGMG-03A_A 147: SGMG-44A/C 146: SGMG-30A/C 145: SGMG-20A/C 144: SGMG-13A/C 143: SGMG-09A/C		0	255	
1064	0	Setting of motor selection code for 4th axis 177: SGMG-44A_A 142: SGMG-05A/C 176: SGMG-30A_A 0: Non 175: SGMG-20A_A 174: SGMG-12A_A 173: SGMG-09A_A 172: SGMG-06A_A 171: SGMG-03A_A 147: SGMG-44A/C 146: SGMG-30A/C 145: SGMG-20A/C 144: SGMG-13A/C 143: SGMG-09A/C		0	255	
1065	0	Setting of motor selection code for 5th axis 177: SGMG-44A_A 142: SGMG-05A/C 176: SGMG-30A_A 0: Non 175: SGMG-20A_A 174: SGMG-12A_A 173: SGMG-09A_A 172: SGMG-06A_A 171: SGMG-03A_A 147: SGMG-44A/C 146: SGMG-30A/C 145: SGMG-20A/C 144: SGMG-13A/C 143: SGMG-09A/C		0	255	
1070	0	External torque observer 1st axis 1: Available 0: Not available		0	1	Availability of digital amplifier offset external torque observer
	1	External torque observer 2nd axis 1: Available 0: Not available		0	1	Availability of digital amplifier offset external torque observer
	2	External torque observer 3rd axis 1: Available 0: Not available		0	1	Availability of digital amplifier offset external torque observer
	3	External torque observer 4th axis 1: Available 0: Not available		0	1	Availability of digital amplifier offset external torque observer
	4	External torque observer 5th axis 1: Available 0: Not available		0	1	Availability of digital amplifier offset external torque observer

Address	Bit	Description	Register Units	Minimum Value	Maximum Value	Long Description
1071	0	1st axis motor encoder type 0: Linear scale 1: 15 Bit ABS 11: 8192 INC 2: 15Bit ABS (Rotary axis) 3: 17Bit ABS		0	255	
1072	0	2nd axis motor encoder type 0: Linear scale 1: 15 Bit ABS 11: 8192 INC 2: 15Bit ABS (Rotary axis) 3: 17Bit ABS		0	255	
1073	0	3rd axis motor encoder type 0: Linear scale 1: 15 Bit ABS 11: 8192 INC 2: 15Bit ABS (Rotary axis) 3: 17Bit ABS		0	255	
1074	0	4th axis motor encoder type 0: Linear scale 1: 15 Bit ABS 11: 8192 INC 2: 15Bit ABS (Rotary axis) 3: 17Bit ABS		0	255	
1075	0	5th axis motor encoder type 0: Linear scale 1: 15 Bit ABS 11: 8192 INC 2: 15Bit ABS (Rotary axis) 3: 17Bit ABS		0	255	
1096	0	1st axis Servo Damping control 0: Not executed 1: Executed		0	1	
	1	2nd axis Servo Damping control 0: Not executed 1: Executed		0	1	
	2	3rd axis Servo Damping control 0: Not executed 1: Executed		0	1	
	3	4th axis Servo Damping control 0: Not executed 1: Executed		0	1	
	4	5th axis Servo Damping control 0: Not executed 1: Executed		0	1	

Address	Bit	Description	Register Units	Minimum Value	Maximum Value	Long Description
1097	0	1st axis Reduced vibration when servo stop 0: Not executed 1: Executed		0	1	
	1	2nd axis Reduced vibration when servo stop 0: Not executed 1: Executed		0	1	
	2	3rd axis Reduced vibration when servo stop 0: Not executed 1: Executed		0	1	
	3	4th axis Reduced vibration when servo stop 0: Not executed 1: Executed		0	1	
	4	5th axis Reduced vibration when servo stop 0: Not executed 1: Executed		0	1	
1100		1st Servo axis display name	ascii	0	255	
1103		2nd Servo axis display name	ascii	0	255	
1106		3rd Servo axis display name	ascii	0	255	
1109		4th Servo axis display name	ascii	0	255	
1112		5th Servo axis display name	ascii	0	255	
1142		1st Servo axis automatic system axis name	ascii	0	255	
1145		2nd Servo axis automatic system axis name	ascii	0	255	
1148		3rd Servo axis automatic system axis name	ascii	0	255	
1151		4th Servo axis automatic system axis name	ascii	0	255	
1154		5th Servo axis automatic system axis name	ascii	0	255	
1321		1st axis Error detect-On area	0.001mm	0	255	
1322		2nd axis Error detect-On area	0.001mm	0	255	
1323		3rd axis Error detect-On area	0.001mm	0	255	
1324		4th axis Error detect-On area	0.001mm	0	255	
1325		5th axis Error detect-On area	0.001mm	0	255	
1371		1st axis Reduced vibration level when servo	%	0	100	
1372		2nd axis Reduced vibration level when servo stop	%	0	100	

Address	Bit	Description	Register Units	Minimum Value	Maximum Value	Long Description
1373		3rd axis Reduced vibration level when servo stop	%	0	100	
1374		4th axis Reduced vibration level when servo stop	%	0	100	
1375		5th axis Reduced vibration level when servostop	%	0	100	
1561		1st axis No of teeth of monitor when servo feed change	tooth	1	255	
1562		2nd axis No of teeth of monitor when servo feed change	tooth	0	255	
1563		3rd axis No of teeth of monitor when servo feed change	tooth	0	255	
1564		4th axis No of teeth of monitor when servo feed change	tooth	0	255	
1565		5th axis No of teeth of monitor when servo feed change	tooth	0	255	
1571		1st axis No of teeth of screw side when servo feed change	tooth	0	255	
1572		2nd axis No of teeth of screw side when servo feed change	tooth	0	255	
1573		3rd axis No of teeth of screw side when servo feed change	tooth	0	255	
1574		4th axis No of teeth of screw side when servo feed change	tooth	0	255	
1575		5th axis No of teeth of screw side when servo feed change	tooth	0	255	
1580		1st axis Position loop gain Kp	0.01[1/S]	500	20000	
1581		1st axis Velocity loop gain Kv	0.1[1/S]	350	32767	
1582		1st axis Speed loop integration time constant Ti	0.01msec	26	32767	
1583		1st axis Second position loop gain Kp	0.01[1/S]	500	20000	
1584		1st axis Speed feed forward gain Kvfff	%	0	100	
1585		1st axis Second velocity loop gain Kv	0.1[1/S]	350	32767	
1586		1st axis First step axis torsion filter time	0.01msec	1	32767	
1587		1st axis Second step axis torsion filter time constant Tn	0.01msec	1	32767	
1588		1st axis Third step axis torsion filter time constant Tn	0.01msec	1	32767	
1589		1st axis Monitor board signal selection, multiplication		0	32767	

Address	Bit	Description	Register Units	Minimum Value	Maximum Value	Long Description
1590		2nd axis Position loop gain Kp	0.01[1/S]	500	20000	
1591		2nd axis Velocity loop gain Kv	0.1[1/S]	350	32767	
1592		2nd axis Speed loop integration time constant	0.01msec	26	32767	
1593		2nd axis Second position loop gain Kp	0.01[1/S]	500	20000	
1594		2nd axis Speed feed forward gain Kvfff	%	0	100	
1595		2nd axis Second velocity loop gain Kv	0.1[1/S]	350	32767	
1596		2nd axis First step axis torsion filter time constant Tn	0.01msec	1	32767	
1597		2nd axis Second step axis torsion filter time constant Tn	0.01msec	1	32767	
1598		2nd axis Third step axis torsion filter time constant Tn	0.01msec	1	32767	
1599		2nd axis Monitor board signal selection, multiplication		0	32767	
1600		3rd axis Position loop gain Kp	0.01[1/S]	500	20000	
1601		3rd axis Velocity loop gain Kv	0.1[1/S]	350	32767	
1602		3rd axis Speed loop integration time constant Ti	0.01msec	26	32767	
1603		3rd axis Second position loop gain Kp	0.01[1/S]	500	20000	
1604		3rd axis Speed feed forward gain Kvfff	%	0	100	
1605		3rd axis Second velocity loop gain Kv	0.1[1/S]	350	32767	
1606		3rd axis First step axis torsion filter time constant Tn	0.01msec	1	32767	
1607		3rd axis Second step axis torsion filter time constant Tn	0.01msec	1	32767	
1608		3rd axis Third step axis torsion filter time constant Tn	0.01msec	1	32767	
1609		3rd axis Monitor board signal selection, multiplication		0	32767	
1610		4th axis Position loop gain Kp	0.01[1/S]	500	20000	
1611		4th axis Velocity loop gain Kv	0.1[1/S]	350	32767	
1612		4th axis Speed loop integration time constant Ti	0.01msec	26	32767	
1613		4th axis Second position loop gain Kp	0.01[1/S]	500	20000	

Address	Bit	Description	Register Units	Minimum Value	Maximum Value	Long Description
1614		4th axis Speed feed forward gain Kvfff	%	0	100	
1615		4th axis Second velocity loop gain Kv	0.1[1/S]	350	32767	
1616		4th axis First step axis torsion filter time constant Tn	0.01msec	1	32767	
1617		4th axis Second step axis torsion filter time constant Tn	0.01msec	1	32767	
1618		4th axis Third step axis torsion filter time constant Tn	0.01msec	1	32767	
1619		4th axis Monitor board signal selection,		0	32767	
1620		5th axis Position loop gain Kp	0.01[1/S]	500	20000	
1621		5th axis Velocity loop gain Kv	0.1[1/S]	350	32767	
1622		5th axis Speed loop integration time constant Ti	0.01msec	26	32767	
1623		5th axis Second position loop gain Kp	0.01[1/S]	500	20000	
1624		5th axis Speed feed forward gain Kvfff	%	0	100	
1625		5th axis Second velocity loop gain Kv	0.1[1/S]	350	32767	
1626		5th axis First step axis torsion filter time constant Tn	0.01msec	1	32767	
1627		5th axis Second step axis torsion filter time constant Tn	0.01msec	1	32767	
1628		5th axis Third step axis torsion filter time constant Tn	0.01msec	1	32767	
1629		5th axis Monitor board signal selection, multiplication		0	32767	
1641		1st axis Variable in position check No1 area	0.001mm	0	32767	
1642		2nd axis Variable in position check No1 area	0.001mm	0	32767	
1643		3rd axis Variable in position check No1 area	0.001mm	0	32767	
1644		4th axis Variable in position check No1 area	0.001mm	0	32767	
1645		5th axis Variable in position check No1 area	0.001mm	0	32767	
1651		1st axis Variable in position check No2 area	0.001mm	0	32767	For caned cycle and solid tap
1652		2nd axis Variable in position check No2 area	0.001mm	0	32767	For caned cycle and solid tap

Address	Bit	Description	Register Units	Minimum Value	Maximum Value	Long Description
1653		3rd axis Variable in position check No2 area	0.001mm	0	32767	For caned cycle and solid tap
1654		4th axis Variable in position check No2 area	0.001mm	0	32767	For caned cycle and solid tap
1655		5th axis Variable in position check No2 area	0.001mm	0	32767	For caned cycle and solid tap
1671		1st axis torque limit value (+)	%	1	32767	
1672		2nd axis torque limit value (+)	%	0	32767	
1673		3rd axis torque limit value (+)	%	0	32767	
1674		4th axis torque limit value (+)	%	0	32767	
1675		5th axis torque limit value (+)	%	0	32767	
1681		1st axis Servo Damping, observer time constant	Hz	0	32767	
1682		2nd axis Servo Damping, observer time	Hz	0	32767	
1683		3rd axis Servo Damping, observer time constant	Hz	0	32767	
1684		4th axis Servo Damping, observer time constant	Hz	0	32767	
1685		5th axis Servo Damping, observer time constant	Hz	0	32767	
1701		1st axis Servo Damping, load inertia fine adjust	%	0	10000	
1702		2nd axis Servo Damping, load inertia fine adjust	%	0	10000	
1703		3rd axis Servo Damping, load inertia fine	%	0	10000	
1704		4th axis Servo Damping, load inertia fine adjust	%	0	10000	
1705		5th axis Servo Damping, load inertia fine adjust	%	0	10000	
1751		1st axis Servo Damping, high pass filter time const	micro sec	0	32767	
1752		2nd axis Servo Damping, high pass filter time const	micro sec	0	32767	
1753		3rd axis Servo Damping, high pass filter time const	micro sec	0	32767	
1754		4th axis Servo Damping, high pass filter time const	micro sec	0	32767	
1755		5th axis Servo Damping, high pass filter time const	micro sec	0	32767	
1791		1st axis Servo Damping, low pass filter time const	micro sec	0	32767	

Address	Bit	Description	Register Units	Minimum Value	Maximum Value	Long Description
1792		2nd axis Servo Damping, low pass filter time	micro sec	0	32767	
1793		3rd axis Servo Damping, low pass filter time const	micro sec	0	32767	
1794		4th axis Servo Damping, low pass filter time const	micro sec	0	32767	
1795		5th axis Servo Damping, low pass filter time const	micro sec	0	32767	
1811		1st axis Servo Damping, compensation gain	%	-2000	2000	
1812		2nd axis Servo Damping, compensation gain	%	-2000	2000	
1813		3rd axis Servo Damping, compensation gain	%	-2000	2000	
1814		4th axis Servo Damping, compensation gain	%	-2000	2000	
1815		5th axis Servo Damping, compensation gain	%	-2000	2000	
1821		1st axis Motion amount or table rotation angle/motor rev	0.001mm	0	1E+09	
1822		2nd axis Motion amount or table rotation angle/motor rev	0.001mm	0	1E+09	
1823		3rd axis Motion amount or table rotation angle/motor rev	0.001mm	0	1E+09	
1824		4th axis Motion amount or table rotation angle/motor rev	0.001mm	0	1E+09	
1825		5th axis Motion amount or table rotation angle/motor rev	0.001mm	0	1E+09	
1831		1st axis load inertia	%	0	32767	
1832		2nd axis load inertia	%	0	32767	
1833		3rd axis load inertia	%	0	32767	
1834		4th axis load inertia	%	0	32767	
1835		5th axis load inertia	%	0	32767	
2001	7	Variable in position check		0	1	

Address	Bit	Description	Register Units	Minimum Value	Maximum Value	Long Description
5015	0	1st axis PLC control axis switch over		0	1	
	1	2nd axis PLC control axis switch over		0	1	
	2	3rd axis PLC control axis switch over		0	1	
	3	4th axis PLC control axis switch over		0	1	
	4	5th axis PLC control axis switch over		0	1	
5101		1st axis PLC axis control group		0	3	
5102		2nd axis PLC axis control group		0	3	
5103		3rd axis PLC axis control group		0	3	
5104		4th axis PLC axis control group		0	3	
5105		5th axis PLC axis control group		0	3	
6006	0	Axis disconnection 1st axis		0	1	
	1	Axis disconnection 2nd axis		0	1	
	2	Axis disconnection 3rd axis		0	1	
	3	Axis disconnection 4th axis		0	1	
	4	Axis disconnection 5th axis		0	1	

Address	Bit	Description	Register Units	Minimum Value	Maximum Value	Long Description
6422		2nd axis, pitch error reference point memory number		0	1151	
6423		3rd axis, pitch error reference point memory number		0	1151	
6424		4th axis, pitch error reference point memory number		0	1151	
6425		5th axis, pitch error reference point memory number		0	1151	
6801		1st axis, pitch error compensation intervals	0.001mm	0	99999999	
6802		2nd axis, pitch error compensation intervals	0.001mm	0	99999999	
6803		3rd axis, pitch error compensation intervals	0.001mm	0	99999999	
6804		4th axis, pitch error compensation intervals	0.001mm	0	99999999	
6805		5th axis, pitch error compensation intervals	0.001mm	0	99999999	
6861		1st axis, pitch error compensation stroke (maximum)	0.001mm	-99999999	99999999	
6862		2nd axis, pitch error compensation stroke (maximum)	0.001mm	-99999999	99999999	
6863		3rd axis, pitch error compensation stroke (maximum)	0.001mm	-99999999	99999999	
6864		4th axis, pitch error compensation stroke (maximum)	0.001mm	-99999999	99999999	
6865		5th axis, pitch error compensation stroke (maximum)	0.001mm	-99999999	99999999	
6871		1st axis, pitch error compensation stroke (minimum)	0.001mm	-99999999	99999999	
6872		2nd axis, pitch error compensation stroke (minimum)	0.001mm	-99999999	99999999	
6873		3rd axis, pitch error compensation stroke (minimum)	0.001mm	-99999999	99999999	
6874		4th axis, pitch error compensation stroke (minimum)	0.001mm	-99999999	99999999	
6875		5th axis, pitch error compensation stroke (minimum)	0.001mm	-99999999	99999999	
6881		1st axis, pitch error comp reference point position	0.001mm	-99999999	99999999	
6882		2nd axis, pitch error comp reference point position	0.001mm	-99999999	99999999	
6883		3rd axis, pitch error comp reference point position	0.001mm	-99999999	99999999	

Address	Bit	Description	Register Units	Minimum Value	Maximum Value	Long Description
6884		4th axis, pitch error comp reference point position	0.001mm	-999999999	999999999	
6885		5th axis, pitch error comp reference point position	0.001mm	-999999999	999999999	

Programming

Address	Bit	Description	Register Units	Minimum Value	Maximum Value	Long Description
7	0	Selection of input unit		0	1	
50	0	Cylindrical coordinate interpolation rotary axis		0	1	Cylindrical coordinate interpolation mode rotary axis input unit select
100		Cylindrical coordinate interpolation linear		0	5	Cylindrical coordinate interpolation linear axis number
101		Cylindrical coordinate interpolation rotary axis		0	5	Cylindrical coordinate interpolation rotary axis number
105		Polarity coordinate interpolation linear axis		0	5	Polarity coordinate interpolation linear axis number
106		Polarity coordinate interpolation rotary axis		0	5	Polarity coordinate interpolation rotary axis number

Address	Bit	Description	Register Units	Minimum Value	Maximum Value	Long Description
400		Dwell period for G76, G77	msec	0	32767	
401		Pitch dwell period for G73, G83	msec	0	32767	
801		Sequence number setting 1 of brake point		0	99999	
802		Sequence number setting 2 of brake point		0	99999	
803		Scaling multiple setting (1)	0.001	0	99999	Ratio = Scaling multiple setting (1)(pm0803) /Scaling multiple setting (2)(pm0804)
804		Scaling multiple setting (2)	0.001	0	1000000	Ratio = Scaling multiple setting (1)(pm0803) /Scaling multiple setting (2)(pm0804)
805		Angle when G76, G77 are specified	0.001deg	0	360000	
820		F1 digit feedrate (F1)	0.1mm/min	0	2400000	
821		F1 digit feedrate (F2)	0.1mm/min	0	2400000	
822		F1 digit feedrate (F3)	0.1mm/min	0	2400000	
823		F1 digit feedrate (F4)	0.1mm/min	0	2400000	
824		F1 digit feedrate (F5)	0.1mm/min	0	2400000	
825		F1 digit feedrate (F6)	0.1mm/min	0	2400000	
826		F1 digit feedrate (F7)	0.1mm/min	0	2400000	
827		F1 digit feedrate (F8)	0.1mm/min	0	2400000	
828		F1 digit feedrate (F9)	0.1mm/min	0	2400000	
870		Return amount of G73	0.001mm	0	999999999	Return stroke in G73 cycle (rapid traverse)
871		Return amount of G83	0.001mm	0	999999999	Return stroke in G83 cycle (rapid traverse)
873		Return amount of G184/G174	0.001mm	0	999999999	Returns stroke in G184/G174 cycle (rapid traverse)
2004	0	Feedrate at the detection of 0.001mm or 0.0001inch		0	1	
2111		F1 command variation in feedrate/ graduation of HPG	0.1mm/min	0	255	
2112		F2 command variation in feedrate/ graduation of HPG	0.1mm/min	0	255	
2113		F3 command variation in feedrate/ graduation of HPG	0.1mm/min	0	255	
2114		F4 command variation in feedrate/ graduation of HPG	0.1mm/min	0	255	

Address	Bit	Description	Register Units	Minimum Value	Maximum Value	Long Description
2115		F5 command variation in feedrate/ graduation of HPG	0.1mm/min	0	255	
2116		F6 command variation in feedrate/ graduation of HPG	0.1mm/min	0	255	
2117		F7 command variation in feedrate/ graduation of HPG	0.1mm/min	0	255	
2118		F8 command variation in feedrate/ graduation of HPG	0.1mm/min	0	255	
2119		F9 command variation in feedrate/ graduation of	0.1mm/min	0	255	
2862		Speed in high speed section during G12/G13	mm/min	0	240000	
2864		Shift speed of canned cycle G76 and G77	mm/min	0	240000	
2865		Maximum feedrate of F1 -digit (F1 - F4) command	mm/min, deg/min	0	240000	
2866		Maximum feedrate of F1 -digit (F5 - F9) command	mm/min, deg/min	0	240000	
3001	4	Priority between T / M06 if specify in same block		0	1	
4000	0	Selection of 01 G code group when power ON /		0	1	
	1	Selection of 03 G code group when power ON		0	1	
	2	Selection of 04 G code group when power ON		0	1	
	3	Selection of 08 G code group when power ON		0	2	
	5	Selection of 02 G code group when NC Reset		0	1	
	6	Selection of 03 G code group when the NC Reset		0	1	
4001	0	Mirror image mode when power ON or Reset		0	1	
	1	Tool radius offset mode when power ON or Reset		0	1	
	2	Mirror image for intermediate position of G28		0	1	Assumption of mirror image ON for the intermediate positioning point of G28 if M95 is set when power ON or NC Reset

Address	Bit	Description	Register Units	Minimum Value	Maximum Value	Long Description
4010	0	Processing after the change of offset amount		0	1	
	1	D code in the G12/G13 mode		0	1	
	6	Processing of D code after reset		0	1	
	7	H code after reset or reference point return		0	1	
4011	1	Designation of offset number for G45 - G48		0	1	
	2	Manual ABS if no axis command in the block 1		0	1	Validity of manual absolute function if there is no axis move command in the block where incremental amount is generated
	3	Manual ABS if no axis command in the block 2		0	1	Validity of manual absolute function if there is no axis move command in the block where incremental amount is generated
	7	Manual ABS for the incremental command		0	1	is generated
4012	0	Processing after the change of work shift amount		0	1	
	6	Tool radius offset start-up and cancel spec type		0	1	
	7	Work shift coordinate setting expansion address		0	1	
4013	0	Tool radius offset Start-up and cancel motion		0	1	
	1	Tool radius offset switching point of		0	1	
	2	Tool radius offset process after the offset amount change		0	1	
	3	Tool radius offset availability of interference check		0	1	
	4	Tool radius offset process after detection of interference		0	1	

Address	Bit	Description	Register Units	Minimum Value	Maximum Value	Long Description
4014	0	1st axis Direction of G60 unidirectional positioning		0	1	
	1	2nd axis Direction of G60 unidirectional positioning		0	1	
	2	3rd axis Direction of G60 unidirectional positioning		0	1	
	3	4th axis Direction of G60 unidirectional positioning		0	1	
	4	5th axis Direction of G60 unidirectional positioning		0	1	
4015	1	Allowable error range check for circular arc command		0	1	
	7	Approach speed for program restart		0	1	
4016	1	Positioning mode in a canned cycle		0	1	
	2	M code to be output in the G74/G84 canned cycle		0	1	
	3	Output M05 at hole bottom in G74/G84 cycle		0	1	
	4	Execution type of G184/G174		0	1	
	6	Solid tap in Dry run mode		0	1	
4017	1	Output of M05 before the output of M19 in the G76/G77 cycle		0	1	
	2	Spindle over-ride during the execution of G84/G74 tap cycle		0	1	
	3	Validity of pm0400 dwell time in the G76/G77 cycle		0	1	
	4	Validity of pm0401 pitch dwell time		0	1	
4020	4	Validity of B code macro execution on single block switch		0	1	
	5	Designation of argument in M code macro		0	1	
	6	Designation of multiple M codes in one block in M code macro		0	1	
	7	Designation of multiple S codes in one block in S code macro		0	1	
4021	6	Objective for argument in M (G) code macro call		0	1	
4030	1	Next block buffering stop at T code command execution		0	1	
	7	Alarm occurrence at decimal with 2nd aux code		0	1	
4112		2nd auxiliary command address setting		0	6	

Address	Bit	Description	Register Units	Minimum Value	Maximum Value	Long Description
4400		Advance reading stop M code (1)		0	999	
4401		Advance reading stop M code (2)		0	999	
4402		Advance reading stop M code (3)		0	999	
4403		Advance reading stop M code (4)		0	999	
4404		Advance reading stop M code (5)		0	999	
4405		Advance reading stop M code (6)		0	999	
4406		Advance reading stop M code (7)		0	999	
4407		Advance reading stop M code (8)		0	999	
4408		Advance reading stop M code (9)		0	999	
4409		Advance reading stop M code (10)		0	999	
4450		Small arc skip value in tool radius compensation	0.001mm	0	32767	
4480		G code macro 1 call G code		0	999	
4481		G code macro 2 call G code		0	999	
4482		G code macro 3 call G code		0	999	
4483		G code macro 4 call G code		0	999	
4484		G code macro 5 call G code		0	999	
4485		G code macro 6 call G code		0	999	
4486		G code macro 7 call G code		0	999	
4487		G code macro 8 call G code		0	999	
4488		G code macro 9 call G code		0	999	
4489		G code macro 10 call G code		0	999	
4490		G code macro 11 call G code		0	999	
4491		G code macro 12 call G code		0	999	
4492		G code macro 13 call G code		0	999	
4493		G code macro 14 call G code		0	999	
4494		G code macro 15 call G code		0	999	
4495		G code macro 16 call G code		0	999	
4496		G code macro 17 call G code		0	999	
4497		G code macro 18 call G code		0	999	
4498		G code macro 19 call G code		0	999	
4499		G code macro 20 call G code		0	999	
4500		G code macro 21 call G code		0	999	
4501		G code macro 22 call G code		0	999	
4502		G code macro 23 call G code		0	999	

Address	Bit	Description	Register Units	Minimum Value	Maximum Value	Long Description
4503		G code macro 24 call G code		0	999	
4504		M code macro 1 call M code		0	999	
4505		M code macro 2 call M code		0	999	
4506		M code macro 3 call M code		0	999	
4507		M code macro 4 call M code		0	999	
4508		M code macro 5 call M code		0	999	
4509		M code macro 6 call M code		0	999	
4510		M code macro 7 call M code		0	999	
4511		M code macro 8 call M code		0	999	
4512		M code macro 9 call M code		0	999	
4513		M code macro 10 call M code		0	999	
4514		M code macro 11 call M code		0	999	
4515		M code macro 12 call M code		0	999	
4516		M code macro 13 call M code		0	999	
4517		M code macro 14 call M code		0	999	
4518		M code macro 15 call M code		0	999	
4519		M code macro 16 call M code		0	999	
4520		M code macro 17 call M code		0	999	
4521		M code macro 18 call M code		0	999	
4522		M code macro 19 call M code		0	999	
4523		M code macro 20 call M code		0	999	
4524		M code macro 21 call M code		0	999	
4525		M code macro 22 call M code		0	999	
4526		M code macro 23 call M code		0	999	
4527		M code macro 24 call M code		0	999	
4840		G code macro 1 call program number		0	99999	
4841		G code macro 2 call program number		0	99999	
4842		G code macro 3 call program number		0	99999	
4843		G code macro 4 call program number		0	99999	
4844		G code macro 5 call program number		0	99999	
4845		G code macro 6 call program number		0	99999	

Address	Bit	Description	Register Units	Minimum Value	Maximum Value	Long Description
4846		G code macro 7 call program number		0	99999	
4847		G code macro 8 call program number		0	99999	
4848		G code macro 9 call program number		0	99999	
4849		G code macro 10 call program number		0	99999	
4850		G code macro 11 call program number		0	99999	
4851		G code macro 12 call program number		0	99999	
4852		G code macro 13 call program number		0	99999	
4853		G code macro 14 call program number		0	99999	
4854		G code macro 15 call program number		0	99999	
4855		G code macro 16 call program number		0	99999	
4856		G code macro 17 call program number		0	99999	
4857		G code macro 18 call program number		0	99999	
4858		G code macro 19 call program number		0	99999	
4859		G code macro 20 call program number		0	99999	
4860		G code macro 21 call program number		0	99999	
4861		G code macro 22 call program number		0	99999	
4862		G code macro 23 call program number		0	99999	
4863		G code macro 24 call program number		0	99999	
4864		M code macro 1 call program number		0	99999	
4865		M code macro 2 call program number		0	99999	
4866		M code macro 3 call program number		0	99999	
4867		M code macro 4 call program number		0	99999	

Address	Bit	Description	Register Units	Minimum Value	Maximum Value	Long Description
4868		M code macro 5 call program number		0	99999	
4869		M code macro 6 call program number		0	99999	
4870		M code macro 7 call program number		0	99999	
4871		M code macro 8 call program number		0	99999	
4872		M code macro 9 call program number		0	99999	
4873		M code macro 10 call program number		0	99999	
4874		M code macro 11 call program number		0	99999	
4875		M code macro 12 call program number		0	99999	
4876		M code macro 13 call program number		0	99999	
4877		M code macro 14 call program number		0	99999	
4878		M code macro 15 call program number		0	99999	
4879		M code macro 16 call program number		0	99999	
4880		M code macro 17 call program number		0	99999	
4881		M code macro 18 call program number		0	99999	
4882		M code macro 19 call program number		0	99999	
4883		M code macro 20 call program number		0	99999	
4884		M code macro 21 call program number		0	99999	
4885		M code macro 22 call program number		0	99999	
4886		M code macro 23 call program number		0	99999	
4887		M code macro 24 call program number		0	99999	
4888		S code macro call program number		0	99999	
4889		T code macro call program number		0	99999	
4890		B code macro call program number		0	99999	

Servo Damping Control

Address	Bit	Description	Register Units	Minimum Value	Maximum Value	Long Description
1096	0	1st axis Servo Damping control		0	1	
	1	2nd axis Servo Damping control		0	1	
	2	3rd axis Servo Damping control		0	1	
	3	4th axis Servo Damping control		0	1	
	4	5th axis Servo Damping control		0	1	
1681		1st axis Servo Damping, observer time	Hz	0	32767	
1682		2nd axis Servo Damping, observer time constant	Hz	0	32767	
1683		3rd axis Servo Damping, observer time constant	Hz	0	32767	
1684		4th axis Servo Damping, observer time constant	Hz	0	32767	
1685		5th axis Servo Damping, observer time	Hz	0	32767	

Address	Bit	Description	Register Units	Minimum Value	Maximum Value	Long Description
1701		1st axis Servo Damping, load inertia fine adjust	%	0	10000	
1702		2nd axis Servo Damping, load inertia fine adjust	%	0	10000	
1703		3rd axis Servo Damping, load inertia fine adjust	%	0	10000	
1704		4th axis Servo Damping, load inertia fine adjust	%	0	10000	
1705		5th axis Servo Damping, load inertia fine adjust	%	0	10000	
1751		1st axis Servo Damping, high pass filter time const	micro sec	0	32767	
1752		2nd axis Servo Damping, high pass filter time const	micro sec	0	32767	
1753		3rd axis Servo Damping, high pass filter time const	micro sec	0	32767	
1754		4th axis Servo Damping, high pass filter time const	micro sec	0	32767	
1755		5th axis Servo Damping, high pass filter time const	micro sec	0	32767	
1791		1st axis Servo Damping, low pass filter time const	micro sec	0	32767	
1792		2nd axis Servo Damping, low pass filter time const	micro sec	0	32767	
1793		3rd axis Servo Damping, low pass filter time const	micro sec	0	32767	
1794		4th axis Servo Damping, low pass filter time const	micro sec	0	32767	
1795		5th axis Servo Damping, low pass filter time const	micro sec	0	32767	
1811		1st axis Servo Damping, compensation gain	%	-2000	2000	
1812		2nd axis Servo Damping, compensation gain	%	-2000	2000	
1813		3rd axis Servo Damping, compensation gain	%	-2000	2000	
1814		4th axis Servo Damping, compensation gain	%	-2000	2000	
1815		5th axis Servo Damping, compensation gain	%	-2000	2000	

Skip

Address	Bit	Description	Register Units	Minimum Value	Maximum Value	Long Description
7	2	Occurrence of alarm if no skip signal in skip block		0	1	Occurrence of an alarm if skip signal is not turned ON until the completion of axis move specified in the skip function block.
107		Manual skip measuring point monitor		0	6	
420		Manual skip contact direction monitor No.1				Bit information D1: X+ D2:Y+ D3:Z+ D8:X- D9:Y- D10:Z-
421		Manual skip contact direction monitor No.2				Bit information D1: X+ D2:Y+ D3:Z+ D8:X- D9:Y- D10:Z-
422		Manual skip contact direction monitor No.3				Bit information D1: X+ D2:Y+ D3:Z+ D8:X- D9:Y- D10:Z-

Address	Bit	Description	Register Units	Minimum Value	Maximum Value	Long Description
423		Manual skip contact direction monitor No.4				Bit information D1: X+ D2:Y+ D3:Z+ D8:X- D9:Y- D10:Z-
424		Manual skip contact direction monitor No.5				Bit information D1: X+ D2:Y+ D3:Z+ D8:X- D9:Y- D10:Z-
811		1st axis skip position	0.001mm	-999999999	999999999	Coordinate values when skip signal is operating (1st axis)
812		2nd axis skip position	0.001mm	-999999999	999999999	Coordinate values when skip signal is operating (2nd axis)
813		3rd axis skip position	0.001mm	-999999999	999999999	Coordinate values when skip signal is operating (3rd axis)
814		4th axis skip position	0.001mm	-999999999	999999999	Coordinate values when skip signal is operating (4th axis)
815		5th axis skip position	0.001mm	-999999999	999999999	Coordinate values when skip signal is operating (5th axis)
920		Manual skip position data, No.1 point 1st axis	0.001mm	-999999999	999999999	Manual skip position information, No.1 point (X-Z).
921		Manual skip position data, No.1 point 2nd axis	0.001mm	-999999999	999999999	Manual skip position information, No.1 point (X-Z).
922		Manual skip position data, No.1 point 3rd axis	0.001mm	-999999999	999999999	Manual skip position information, No.1 point (X-Z).
923		Manual skip position data, No.2 point 1st axis	0.001mm	-999999999	999999999	Manual skip position information, No.2 point (X-Z).
924		Manual skip position data, No.2 point 2nd axis	0.001mm	-999999999	999999999	Manual skip position information, No.2 point (X-Z).
925		Manual skip position data, No.2 point 3rd axis	0.001mm	-999999999	999999999	Manual skip position information, No.2 point (X-Z).
926		Manual skip position data, No.3 point 1st	0.001mm	-999999999	999999999	Manual skip position information, No.3 point (X-Z).
927		Manual skip position data, No.3 point 2nd axis	0.001mm	-999999999	999999999	Manual skip position information, No.3 point (X-Z).
928		Manual skip position data, No.3 point 3rd axis	0.001mm	-999999999	999999999	Manual skip position information, No.3 point (X-Z).

Address	Bit	Description	Register Units	Minimum Value	Maximum Value	Long Description
929		Manual skip position data, No.4 point 1st axis	0.001mm	-99999999	99999999	Manual skip position information, No.4 point (X-Z).
930		Manual skip position data, No.4 point 2nd axis	0.001mm	-99999999	99999999	Manual skip position information, No.4 point (X-Z).
931		Manual skip position data, No.4 point 3rd axis	0.001mm	-99999999	99999999	Manual skip position information, No.4 point (X-Z).
932		Manual skip position data, No.5 point 1st axis	0.001mm	-99999999	99999999	Manual skip position information, No.5 point (X-Z).
933		Manual skip position data, No.5 point 2nd axis	0.001mm	-99999999	99999999	Manual skip position information, No.5 point (X-Z).
934		Manual skip position data, No.5 point 3rd axis	0.001mm	-99999999	99999999	Manual skip position information, No.5 point (X-Z).
935		Manual skip position data, No.6 point 1st axis	0.001mm	-99999999	99999999	Manual skip position information, No.6 point (X-Z).
936		Manual skip position data, No.6 point 2nd	0.001mm	-99999999	99999999	Manual skip position information, No.6 point (X-Z).
937		Manual skip position data, No.6 point 3rd	0.001mm	-99999999	99999999	Manual skip position information, No.6 point (X-Z).
2001	0	Feedrate for skip function		0	1	
2440		Speed during execution of skip	mm/min	0	32767	
5010	0	Skip signal		0	1	
5010	5	Skip sensor monitor ON signal timing		0	1	
5010	7	Manual skip B function		0	1	
5011	0	Valid timing of skip signal		0	1	

Spindle

Address	Bit	Description	Register Units	Minimum Value	Maximum Value	Long Description
1000	2	Override setting on spindle speed output		0	1	
	4	Filter for spindle load and speed		0	1	Filtering in the I/O output for the spindle load and speed monitor
1002	0	Magnification ratio of spindle speed parameter		0	1	
1026	0	1st spindle YENET number		0	15	No.1 physical spindle
	5	1st spindle debug mode		0	1	YENET1200 station number setting (No. 2 to No. 15 station)
	6	1st physical spindle specifications		0	1	
	7	1st physical spindle enable		0	1	
1039	1	Spindle servo control type		0	2	
	5	Spindle servo control enable		0	1	
	7	Spindle servo control configuration		0	1	
1091	0	Spindle encoder type		0	255	
1127		Spindle display name	ascii	0	255	
1169		Spindle automatic system axis name	ascii	0	255	
1400		Minimum spindle revolution clamp for gear 1	r/min	0	30000	
1401		Minimum spindle revolution clamp for gear 2	r/min	0	30000	
1402		Minimum spindle revolution clamp for gear 3	r/min	0	30000	
1403		Minimum spindle revolution clamp for gear 4	r/min	0	30000	
1404		Maximum spindle revolution clamp for gear 1	r/min	0	30000	
1405		Maximum spindle revolution clamp for gear 2	r/min	0	30000	
1406		Maximum spindle revolution clamp for gear 3	r/min	0	30000	
1407		Maximum spindle revolution clamp for gear 4	r/min	0	30000	
1408		Spindle max motor speed for gear 1	r/min	0	30000	
1409		Spindle max motor speed for gear 2	r/min	0	30000	

Address	Bit	Description	Register Units	Minimum Value	Maximum Value	Long Description
1410		Spindle max motor speed for gear 3	r/min	0	30000	
1411		Spindle max motor speed for gear 4	r/min	0	30000	
1412		Spindle speed when spindle orientation (SOR) on	r/min	0	32767	
1413		Spindle speed when spindle gear shift (SRO) on	r/min	0	32767	
1415		Spindle, max speed corresponding to 10V command	r/min	0	32767	
1540		Delay time to check the SAGR signal	msec	0	32767	
2471		Spindle accel/decel time constant	msec	0	32767	Set multiple of 4
2472		Spindle accel/decel time constant (gear B)	msec	0	32767	Set multiple of 4
2551		Max spindle motor speed	r/min	0	32767	
5018	0	Gear selection of H gear		0	2	
	2	Gear selection of M gear		0	2	
	4	Gear selection of L gear		0	2	

Software Switch

Address	Bit	Description	Register Units	Minimum Value	Maximum Value	Long Description
0	1	Machine lock switch		0	1	
	2	Dry run switch		0	1	
	3	Block delete switch		0	1	
	4	Manual absolute switch		0	1	
	5	Auxiliary function lock switch		0	1	
	6	Display lock switch		0	1	
	7	Edit Lock switch		0	1	
1	0	Optional stop switch		0	1	
	1	Start lock switch		0	1	
	2	Z-axis neglect switch		0	1	

Address	Bit	Description	Register Units	Minimum Value	Maximum Value	Long Description
2	0	Mirror image 1		0	1	
	1	Mirror image 2		0	1	
	2	Mirror image 3		0	1	
	3	Mirror image 4		0	1	
	4	Mirror image 5		0	1	
3	1	Axis disconnection designation (4th-axis)		0	1	
	2	Axis disconnection designation (5th-axis)		0	1	
5	0	Manual zero return switch		0	1	
	1	No. 2 manual zero return switch		0	1	
	2	Interruption point return switch		0	1	
	3	Automatic mode handle offset switch		0	1	
	4	Setup point return switch		0	1	
	5	Playback switch		0	1	
	6	F1-digit switch		0	1	
	7	Program restart switch		0	1	

Solid Tap

Address	Bit	Description	Register Units	Minimum Value	Maximum Value	Long Description
1240		Spindle number for executing solid tap		0	1	
1241		Servo axis number for executing solid tap		1	5	
1252		Return feedrate multiplication for solid tap	0.1times	1	255	
1260		Spindle loop control gear number (A)		0	4	
1261		Spindle loop control gear number (B)		0	4	

Address	Bit	Description	Register Units	Minimum Value	Maximum Value	Long Description
1331		Error detect-ON area during spindle loop control	0.001mm	0	255	
1332		Error detect-ON area during spindle loop control B	0.001mm	0	255	
1351		Servo error range when spindle loop control	%	0	255	Spindle, Multiplication relative to rapid feed in servo error range for gear B
1352		Servo error range when spindle loop control	%	0	255	Spindle, Multiplication relative to rapid feed in servo error range for gear B
1416		Maximum spindle speed during solid tap	r/min	0	32767	
1417		Spindle position loop gain for solid tap	0.01[1/S]	0	32767	
1418		Spindle C-axis, max speed corresponding to 10V	r/min	0	666	Maximum spindle speed corresponding to 10 V of command (C-axis is used)
1419		Spindle gear A base speed	r/min	0	32767	
1435		Spindle, max speed corresponding to 10V (Gear B)	r/min	0	32767	
1436		Maximum spindle speed during solid tap (Gear B)	r/min	0	32767	
1437		Spindle position loop gain for solid tap (Gear B)	0.01[1/S]	0	32767	
1439		Spindle gear B base speed	r/min	0	32767	
1500		Solid tap servo shaft retraction in-position width	0.001mm	0	32767	
1502		Solid tap synchronization offset parameter K1		-32767	32767	
1503		Solid tap synchronization offset parameter K2		-32767	32767	
1506		Rotary tool spindle sync offset parameter K1		-32767	32676	
1507		Rotary tool spindle sync offset permeate K2		-32767	32676	
1510		No. of teeth of gear A on the spindle side	tooth	0	32767	No. of teeth of gear A on the spindle side for spindle loop control

Address	Bit	Description	Register Units	Minimum Value	Maximum Value	Long Description
1511		No. of teeth of gear A on the spindle intermediate	tooth	0	32767	No. of teeth of the spindle intermediate gear A used for spindle loop control. If there is no intermediate gear, set motor side one
1512		No. of teeth of gear A on the motor intermediate	tooth	0	32767	No. of teeth of the motor intermediate gear A used for spindle loop control. If there is no intermediate gear, set 0
1513		No. of teeth of gear A on the motor side intermediate	tooth	0	32767	No. of teeth on the motor side of gear A used for spindle loop control. If there is no intermediate gear, set 0.
1514		No. of teeth of gear B on the spindle side	tooth	0	32767	No. of teeth of gear B on the spindle side for spindle loop control.
1515		No. of teeth of gear B on the spindle intermediate	tooth	0	32767	No. of teeth of the spindle intermediate gear B used for spindle loop control. If there is no intermediate gear, set 0.
1516		No. of teeth of gear B on the motor intermediate	tooth	0	32767	No. of teeth of the motor intermediate gear B used for spindle loop control If there is no intermediate gear, set 0
1517		No. of teeth of gear B on the motor side intermediate	tooth	0	32767	No. of teeth on the motor side of gear B used for spindle loop control. If there is no intermediate gear, set 0.
2000	1	Dry run during thread cutting		0	1	
2831		1st axis bias in thread cutting accel/ decel	mm/min, deg/min	0	240000	
2832		2nd axis bias in thread cutting accel/ decel	mm/min, deg/min	0	240000	
2833		3rd axis bias in thread cutting accel/ decel	mm/min, deg/min	0	240000	
2834		4th axis bias in thread cutting accel/ decel	mm/min, deg/min	0	240000	
2835		5th axis bias in thread cutting accel/ decel	mm/min, deg/min	0	240000	

Address	Bit	Description	Register Units	Minimum Value	Maximum Value	Long Description
4015	5	G00 error detection during solid tap		0	1	
	6	Display peak value of synchronization error in solid tap		0	1	

Spindle Index

Address	Bit	Description	Register Units	Minimum Value	Maximum Value	Long Description
1053	2	Execution of spindle indexing in loop control		0	1	
	3	C-axis indexing when switching to C-axis		0	1	

Address	Bit	Description	Register Units	Minimum Value	Maximum Value	Long Description
1220		Spindle index confirmation timer	8msec	1	255	
1225		Spindle index stopped confirmation revolutions	r/min	1	255	
1226		Spindle index stopped confirmation revolutions B	r/min	1	255	Spindle index stopped confirmation revolutions at selection of spindle gear B-axis
1414		Spindle indexing origin position	360/ 4096deg	0	4095	
2541		Spindle index starting speed	r/min	1	32767	
2542		Spindle index starting speed when gear B	r/min	0	32767	
2546		Spindle index creeping speed	r/min	0	32767	
2547		Spindle index creeping speed when gear B	r/min	0	32767	

Stroke Limit

Address	Bit	Description	Register Units	Minimum Value	Maximum Value	Long Description
8	0	No. 2 stored stroke limit		0	1	
	1	No. 3 stored stroke limit		0	1	
	2	No. 4 stored stroke limit		0	1	
	3	No. 5 stored stroke limit		0	1	
	4	No. 2 entry prohibited area		0	1	
	5	No. 3 entry prohibited area		0	1	
	6	No. 4 entry prohibited area		0	1	
	7	No. 5 entry prohibited area		0	1	
831		No.2 stored stroke limit 1st axis (+)	0.001mm	-999999999	999999999	
832		No.2 stored stroke limit 2nd axis (+)	0.001mm	-999999999	999999999	
833		No.2 stored stroke limit 3rd axis (+)	0.001mm	-999999999	999999999	
834		No.2 stored stroke limit 1st axis (-)	0.001mm	-999999999	999999999	
835		No.2 stored stroke limit 2nd axis (-)	0.001mm	-999999999	999999999	
836		No.2 stored stroke limit 3rd axis (-)	0.001mm	-999999999	999999999	
837		No.3 stored stroke limit 1st axis (+)	0.001mm	-999999999	999999999	
838		No.3 stored stroke limit 2nd axis (+)	0.001mm	-999999999	999999999	
839		No.3 stored stroke limit 3rd axis (+)	0.001mm	-999999999	999999999	
840		No.3 stored stroke limit 1st axis (-)	0.001mm	-999999999	999999999	
841		No.3 stored stroke limit 2nd axis (-)	0.001mm	-999999999	999999999	
842		No.3 stored stroke limit 3rd axis (-)	0.001mm	-999999999	999999999	
843		No.4 stored stroke limit 1st axis (+)	0.001mm	-999999999	999999999	
844		No.4 stored stroke limit 2nd axis (+)	0.001mm	-999999999	999999999	
845		No.4 stored stroke limit 3rd axis (+)	0.001mm	-999999999	999999999	
846		No.4 stored stroke limit 1st axis (-)	0.001mm	-999999999	999999999	
847		No.4 stored stroke limit 2nd axis (-)	0.001mm	-999999999	999999999	
848		No.4 stored stroke limit 3rd axis (-)	0.001mm	-999999999	999999999	
849		No.5 stored stroke limit 1st axis (+)	0.001mm	-999999999	999999999	
850		No.5 stored stroke limit 2nd axis (+)	0.001mm	-999999999	999999999	
851		No.5 stored stroke limit 3rd axis (+)	0.001mm	-999999999	999999999	
852		No.5 stored stroke limit 1st axis (-)	0.001mm	-999999999	999999999	
853		No.5 stored stroke limit 2nd axis (-)	0.001mm	-999999999	999999999	
854		No.5 stored stroke limit 3rd axis (-)	0.001mm	-999999999	999999999	

Address	Bit	Description	Register Units	Minimum Value	Maximum Value	Long Description
6002	0	No.1 stored stroke limit check 1st axis execution		0	1	
	1	No.1 stored stroke limit check 2nd axis execution		0	1	
6004	0	Execution of stored stroke limit check for rotary 1st axis		0	1	
	1	Execution of stored stroke limit check for rotary 2nd axis		0	1	
	2	Execution of stored stroke limit check for rotary 3rd axis		0	1	
	3	Execution of stored stroke limit check for rotary 4th axis		0	1	
	4	Execution of stored stroke limit check for rotary 5th axis		0	1	
6111		No.2 stored stroke limit check 1st axis		0	5	
6112		No.2 stored stroke limit check 2nd axis		0	5	
6113		No.2 stored stroke limit check 3rd axis		0	5	
6114		No.3 stored stroke limit check 1st axis		0	5	
6115		No.3 stored stroke limit check 2nd axis		0	5	
6116		No.3 stored stroke limit check 3rd axis		0	5	
6117		No.4 stored stroke limit check 1st axis		0	5	
6118		No.4 stored stroke limit check 2nd axis		0	5	
6119		No.4 stored stroke limit check 3rd axis		0	5	
6120		No.5 stored stroke limit check 1st axis		0	5	
6121		No.5 stored stroke limit check 2nd axis		0	5	
6122		No.5 stored stroke limit check 3rd axis		0	5	
6901		No.1 stored stroke limit 1st axis (+)	0.001mm	-999999999	999999999	
6902		No.1 stored stroke limit 2nd axis (+)	0.001mm	-999999999	999999999	
6903		No.1 stored stroke limit 3rd axis (+)	0.001mm	-999999999	999999999	
6904		No.1 stored stroke limit 4th axis (+)	0.001mm	-999999999	999999999	
6905		No.1 stored stroke limit 5th axis (+)	0.001mm	-999999999	999999999	

Address	Bit	Description	Register Units	Minimum Value	Maximum Value	Long Description
6911		No.1 stored stroke limit 1st axis (-)	0.001mm	-99999999	99999999	
6912		No.1 stored stroke limit 2nd axis (-)	0.001mm	-99999999	99999999	
6913		No.1 stored stroke limit 3rd axis (-)	0.001mm	-99999999	99999999	
6914		No.1 stored stroke limit 4th axis (-)	0.001mm	-99999999	99999999	
6915		No.1 stored stroke limit 5th axis (-)	0.001mm	-99999999	99999999	

System

Address	Bit	Description	Register Units	Minimum Value	Maximum Value	Long Description
48	0	Servo current adjustment		0	1	Servo U-phase V-phase current command offset adjustment

Address	Bit	Description	Register Units	Minimum Value	Maximum Value	Long Description
109		Internal system number switch setting		0	1	
4001	7	Cycle start interlock when system number		0	1	System number switch "1" or pm0109 = 1
5012	0	Servo power ON method		0	1	
	3	SVMX Off function				

Tool Coordinate

Address	Bit	Description	Register Units	Minimum Value	Maximum Value	Long Description
3000	2	Add of tool offset amount in Z axis position disp		0	1	
3800		Tool ware offset input maximum value	0.001mm	0	999999	
4029	0	Use separate H and D offset data area		0	1	

Tool Life

Address	Bit	Description	Register Units	Minimum Value	Maximum Value	Long Description
7	4	Tool life control by T command		0	1	
9	6	Number of tool life control groups and tools		0	3	
4029	1	Setting of the tool group in the skip status		0	1	
4030	2	Tool life count at M02/M03 execution		0	1	
	3	Skip input timing when count M02/M30 type		0	1	
4110		Tool life control group command T code offset		0	19	Tool life control group (0-19) = T command - pm4110 x 1000

Tool Magazine

Address	Bit	Description	Register Units	Minimum Value	Maximum Value	Long Description
3001	6	Tool magazine/ATC tool display digit type		0	1	
3003	6	ATC tool 4 digit type keep memory data type		0	1	
3422		Tool magazine display start keep memory parameter No		7000	7999	
3423		Tool magazine display end keep memory parameter No.		7000	7999	
3424		ATC magazien tool keep memory parameter No.		7000	7999	
3425		ATC spindle tool keep memory parameter No.		7000	7999	

Tool/Work Coordinate

Address	Bit	Description	Register Units	Minimum Value	Maximum Value	Long Description
7	3	Addition of work shift update amount		0	1	
3000	2	Add of tool offset amount in Z axis position disp		0	1	
3800		Tool ware offset input maximum value	0.001mm	0	999999	
4001	3	Presetting of work coordinate shift when		0	1	G54 - G59 can be select by pm4143
	4	Presetting of work coordinate shift at Zero return		0	1	G54 - G59 can be select by pm4143
4006	0	1st axis Automatic coordinate system setting		0	1	
	1	2nd axis Automatic coordinate system setting		0	1	
	2	3rd axis Automatic coordinate system setting		0	1	
	3	4th axis Automatic coordinate system setting		0	1	
	4	5th axis Automatic coordinate system setting		0	1	
4029	0	Use separate H and D offset data area		0	1	
4143		Work shift setup when power on or zero return		0	59	
4801		1st axis automatic coordinate setup value when mm	0.001mm	-999999999	999999999	
4802		2nd axis automatic coordinate setup value when mm	0.001mm	-999999999	999999999	
4803		3rd axis automatic coordinate setup value when mm	0.001mm	-999999999	999999999	
4804		4th axis automatic coordinate setup value when mm	0.001mm	-999999999	999999999	
4805		5th axis automatic coordinate setup value when mm	0.001mm	-999999999	999999999	
4811		1st axis automatic coordinate setup value when inch	0.0001inch	-393700787	393700787	
4812		2nd axis automatic coordinate setup value when inch	0.0001inch	-393700787	393700787	
4813		3rd axis automatic coordinate setup value when inch	0.0001inch	-393700787	393700787	
4814		4th axis automatic coordinate setup value when inch	0.0001inch	-393700787	393700787	

Address	Bit	Description	Register Units	Minimum Value	Maximum Value	Long Description
4815		5th axis automatic coordinate setup value when inch	0.0001inch	-393700787	393700787	

Tooling

Address	Bit	Description	Register Units	Minimum Value	Maximum Value	Long Description
7	4	Tool life control by T command		0	1	
9	6	Number of tool life control groups and tools		0	3	
806		Tool length measurement bias amount	0.001mm	-999999999	999999999	
807		Tool length measurement bottom level	0.001mm	-999999999	999999999	
3001	3	Simplified TLM		0	1	
3001	6	Tool magazine/ATC tool display digit type		0	1	
3003	6	ATC tool 4 digit type keep memory data type		0	1	
3422		Tool magazine display start keep memory		7000	7999	
3423		Tool magazine display end keep memory parameter No.		7000	7999	
3424		ATC magazin tool keep memory parameter No.		7000	7999	
3425		ATC spindle tool keep memory parameter No.		7000	7999	
4029	1	Setting of the tool group in the skip status		0	1	
4030	2	Tool life count at M02/M03 execution		0	1	
4030	3	Skip input timing when count M02/M30 type		0	1	
4110		Tool life control group command T code offset		0	19	Tool life control group (0-19) = T command - pm4110 x 1000
5012	1	Measuring by work/offset presetter		0	1	
	2	Mode of measuring by work/offset presetter		0	1	

Address	Bit	Description	Register Units	Minimum Value	Maximum Value	Long Description
5013	0	Tool measuring direction by offset presetter		0	1	
	2	Validity of when both offset presetter/TLM are on		0	1	
	3	Execution of TLM measurement in manual skip B		0	1	
	4	TLM home position return when ROV=0%		0	1	
6008	0	Measuring objective by tool length measurement		0	1	
6840		Offset presetter measuring direction reference value, X0	0.001mm	-999999999	999999999	
6841		Offset presetter measuring direction reference value, Z0	0.001mm	-999999999	999999999	
6842		Work presetter measuring probe radius, (DX+)	0.001mm	-999999999	999999999	
6843		Work presetter measuring probe radius, (DX-)	0.001mm	-999999999	999999999	
6844		Work presetter measuring probe radius, (DY+)	0.001mm	-999999999	999999999	
6845		Work presetter measuring probe radius, (DY-)	0.001mm	-999999999	999999999	
6846		Work presetter measuring probe radius, (HZ-)	0.001mm	-999999999	999999999	
6847		Work presetter measuring enabled retraction stroke	0.001mm	-999999999	999999999	
6848		Work presetter measuring point feed-away stroke	0.001mm	-999999999	999999999	

Torque Limit

Address	Bit	Description	Register Units	Minimum Value	Maximum Value	Long Description
1671		1st axis torque limit value (+)	%	1	32767	
1672		2nd axis torque limit value (+)	%	0	32767	
1673		3rd axis torque limit value (+)	%	0	32767	
1674		4th axis torque limit value (+)	%	0	32767	
1675		5th axis torque limit value (+)	%	0	32767	

Variable in Position

Address	Bit	Description	Register Units	Minimum Value	Maximum Value	Long Description
1641		1st axis Variable in position check No1 area	0.001mm	0	32767	
1642		2nd axis Variable in position check No1 area	0.001mm	0	32767	
1643		3rd axis Variable in position check No1 area	0.001mm	0	32767	
1644		4th axis Variable in position check No1 area	0.001mm	0	32767	
1645		5th axis Variable in position check No1 area	0.001mm	0	32767	
1651		1st axis Variable in position check No2 area	0.001mm	0	32767	For caned cycle and solid tap
1652		2nd axis Variable in position check No2 area	0.001mm	0	32767	For caned cycle and solid tap
1653		3rd axis Variable in position check No2 area	0.001mm	0	32767	For caned cycle and solid tap
1654		4th axis Variable in position check No2 area	0.001mm	0	32767	For caned cycle and solid tap
1655		5th axis Variable in position check No2 area	0.001mm	0	32767	For caned cycle and solid tap
2001	7	Variable in position check		0	1	

Work Coordinate

Address	Bit	Description	Register Units	Minimum Value	Maximum Value	Long Description
7	3	Addition of work shift update amount		0	1	
4001	3	Presetting of work coordinate shift when power ON		0	1	G54 - G59 can be selected by pm4143
	4	Presetting of work coordinate shift at Zero return		0	1	G54 - G59 can be selected by pm4143
4006	0	1st axis Automatic coordinate system setting		0	1	
	1	2nd axis Automatic coordinate system setting		0	1	
	2	3rd axis Automatic coordinate system setting		0	1	
	3	4th axis Automatic coordinate system setting		0	1	
	4	5th axis Automatic coordinate system setting		0	1	
4143		Work shift setup when power on or zero return		0	59	
4801		1st axis automatic coordinate setup value when mm	0.001mm	-999999999	999999999	
4802		2nd axis automatic coordinate setup value when mm	0.001mm	-999999999	999999999	
4803		3rd axis automatic coordinate setup value when mm	0.001mm	-999999999	999999999	
4804		4th axis automatic coordinate setup value when mm	0.001mm	-999999999	999999999	
4805		5th axis automatic coordinate setup value when mm	0.001mm	-999999999	999999999	
4811		1st axis automatic coordinate setup value when inch	0.0001inch	-393700787	393700787	

Address	Bit	Description	Register Units	Minimum Value	Maximum Value	Long Description
4812		2nd axis automatic coordinate setup value when inch	0.0001inch	-393700787	393700787	
4813		3rd axis automatic coordinate setup value when inch	0.0001inch	-393700787	393700787	
4814		4th axis automatic coordinate setup value when inch	0.0001inch	-393700787	393700787	
4815		5th axis automatic coordinate setup value when inch	0.0001inch	-393700787	393700787	

INDEX

A

active alarms 120
 active M codes 28
 alarm history file 123
 Alarm History Screen 122
 alarm message area 3
 ATC tool number 24
 Axis Data 95

B

Backup 84
 Backup and Restore Screen 84
 Battery Indicator 2
 battery indicator 2
 BUFn 2

C

calculator 6
 CNC parameters 97
 command values 28
 compensation values 64
 Configuration Screen 81
 context-sensitive help 11
 COR 2
 correction value 70
 current program 58
 current run time 25

cutting speed 24
CWAIT 3
Cycle Start Timer 35

D

Distance To Go 14
Drive Configuration 82
DWELL 3

E

Editor Screen 48
execution status 2
External Timer 36

F

Feed Cutting Timer 35
FH 2
file management 40
Finding the center of a part 71

G

G Code Display 28
G54 70
getting and putting numbers 7
GHC 2

H

Handle 4
High Speed Screen 100
high-speed mode 25
HSC parameters 100

J

Jog 4

L

Ladder Monitor Screen 115
last run time 25
Login Screen 75

M

Machine 14
macro alarm 120
Maintenance Screen 80
MAN-F 3
manual modes 15

Manual Screen 126
MDI 5
Measure 14
Mem 5
menubar 13
MMI Map Screen 125
modal G codes 28
Mode Indicator 4
motion status 3
MTB Install Screen 105
multiple alarms 3

N

Nc Alarm Screen 119
NC Configuration 81
NC Parameters Screen 92
nested subprograms 18, 26
non-modal G codes 28
Number Field 18

O

Offsets Screen 63

P

Parameter Search Screen 97
parameter writing 76
Part count 25
part counter 25
Percent done 25
Pitch Error Screen 93
PLC Alarm Screen 121
PLC Diagnosis Screen 108
PLC errors 121
PLC Parameters Screen 107
Position Error 14
Positioning the cursor 17
Power On Timer 35
Production data 25
Production Screen 23, 129
PRS 2

R

Rapid 4
Restore 85
RST 2
Run time 25

S

SAGR 3
screen navigation 4
sequence number 24
Setting Parameters Screen 89
SHC 2
Single line MDI 5
Skip Zero Data 86
software switches 33
spindle load 24
spindle speed 24
status bar 1
STP 2
subprogram name 18
System Screen 78

T

tool geometry 64
tool offsets 28, 64
tool stickout 65
tool wear 64

U

User Install Screen 102

W

Workpiece 14
workpiece coordinate systems 70
Workshift 70
Workshift Screen 69



YASKAWA ELECTRIC AMERICA, INC.

Chicago-Corporate Headquarters 2121 Norman Drive South, Waukegan, IL 60085, U.S.A.
Phone: (847) 887-7000 Fax: (847) 887-7310 Internet: <http://www.yaskawa.com>

MOTOMAN INC.

805 Liberty Lane, West Carrollton, OH 45449, U.S.A.
Phone: (937) 847-6200 Fax: (937) 847-6277

YASKAWA ELECTRIC CORPORATION

New Pier Takeshiba South Tower, 1-16-1, Kaigan, Minatoku, Tokyo, 105-0022, Japan
Phone: 81-3-5402-4511 Fax: 81-3-5402-4580 Internet: <http://www.yaskawa.co.jp>

YASKAWA ELETRICO DO BRASIL COMERCIO LTDA.

Avenida Fagundes Filho, 620 Bairro Saude Sao Paulo-SP, Brasil CEP: 04304-000
Phone: 55-11-5071-2552 Fax: 55-11-5581-8795 E-mail: yaskawabrasil@originet.com.br

YASKAWA ELECTRIC EUROPE GmbH

Am Kronberger Hang 2, 65824 Schwalbach, Germany
Phone: 49-6196-569-300 Fax: 49-6196-888-301 Internet: <http://www.yaskawa.de>

MOTOMAN ROBOTICS AB

Box 504 S38525, Torsas, Sweden
Phone: 46-486-48800 Fax: 46-486-41410

MOTOMAN ROBOTEC GmbH

Kammerfeldstraße 1, 85391 Allershausen, Germany
Phone: 49-8166-900 Fax: 49-8166-9039

YASKAWA ELECTRIC UK LTD.

1 Hunt Hill Orchardton Woods Cumbernauld, G68 9LF, Scotland, United Kingdom
Phone: 44-12-3673-5000 Fax: 44-12-3645-8182

YASKAWA ELECTRIC KOREA CORPORATION

Paik Nam Bldg. 901 188-3, 1-Ga Euljiro, Joong-Gu, Seoul, Korea
Phone: 82-2-776-7844 Fax: 82-2-753-2639

YASKAWA ELECTRIC (SINGAPORE) PTE. LTD.

Head Office: 151 Lorong Chuan, #04-01, New Tech Park Singapore 556741, SINGAPORE
Phone: 65-282-3003 Fax: 65-289-3003

TAIPEI OFFICE (AND YATEC ENGINEERING CORPORATION)

10F 146 Sung Chiang Road, Taipei, Taiwan
Phone: 886-2-2563-0010 Fax: 886-2-2567-4677

YASKAWA JASON (HK) COMPANY LIMITED

Rm. 2909-10, Hong Kong Plaza, 186-191 Connaught Road West, Hong Kong
Phone: 852-2803-2385 Fax: 852-2547-5773

BEIJING OFFICE

Room No. 301 Office Building of Beijing International Club,
21 Jianguomanwai Avenue, Beijing 100020, China
Phone: 86-10-6532-1850 Fax: 86-10-6532-1851

SHANGHAI OFFICE

27 Hui He Road Shanghai 200437 China
Phone: 86-21-6553-6600 Fax: 86-21-6531-4242

SHANGHAI YASKAWA-TONJI M & E CO., LTD.

27 Hui He Road Shanghai 200437 China
Phone: 86-21-6533-2828 Fax: 86-21-6553-6677

BEIJING YASKAWA BEIKE AUTOMATION ENGINEERING CO., LTD.

30 Xue Yuan Road, Haidian, Beijing 100083 China
Phone: 86-10-6232-9943 Fax: 86-10-6234-5002

SHOUGANG MOTOMAN ROBOT CO., LTD.

7, Yongchang-North Street, Beijing Economic & Technological Development Area,
Beijing 100076 China

Phone: 86-10-6788-0551 Fax: 86-10-6788-2878